

## CALIFORNIA



### Proposition 65 Warning

WARNING: Diesel engine exhaust and some of its constituents are known to the State of California to cause cancer and birth defects or other reproductive harm.

WARNING: Battery posts, terminals, and related accessories contain lead and lead compounds, and chemicals known to the State of California to cause cancer and birth defects or other reproductive harm.

# NOTICE

ANY PICTURES CONTAINED WITHIN THIS OPERATOR'S MANUAL THAT DEPICT SITUATIONS WITH SHIELDS, GUARDS, RAILS, OR LIDS REMOVED ARE FOR DEMONSTRATION ONLY. HAGIE MANUFACTURING STRONGLY URGES THE OPERATOR TO KEEP ALL SHIELDS AND SAFETY DEVICES IN PLACE AT ALL TIMES.



**OPERATOR'S MANUAL  
FOR  
HAGIE MODEL STS 14 HI-TRACTOR**

**HAGIE MANUFACTURING COMPANY**

721 CENTRAL AVENUE WEST  
BOX 273  
CLARION, IOWA 50525-0273

(515) 532-2861

COVERS MACHINE SERIAL NUMBERS:U1631111001 thru U1631111100

07-10 493509

05-11

© 2010 Hagie Manufacturing Company. Clarion, Iowa USA

# INTRODUCTION

---



## A WORD FROM HAGIE MANUFACTURING COMPANY

Congratulations on your selection of a Hagie Model STS 14 SPRAYER. We recommend that you study this Operator's Manual and become acquainted with the adjustments and operating procedures before attempting to operate your new sprayer. As with any piece of equipment, certain operating procedures, service, and maintenance are required to keep it in top running condition.

We have attempted herein to cover all of the adjustments required to fit varying conditions. However, there may be times when special care must be considered.

Hagie Manufacturing Company reserves the right to make changes in the design and material of any subsequent sprayer without obligation to existing units.

We thank you for choosing a Hagie sprayer and assure you of our continued interest in its satisfactory operation for you. If we might be of assistance to you, please call us.

We are proud to have you as a customer.

# INTRODUCTION

## TO THE OPERATOR:

The following pages and illustrations will help you operate and service your new sprayer. It is the responsibility of the user to read the Operator's Manual and comply with the safe correct operating procedures and lubricate and maintain the product according to the maintenance schedule.

The user is responsible for inspecting the machine and having parts repaired or replaced when continued use of the product causes damage or excessive wear to other parts.

Keep this manual in a convenient place for easy reference when problems arise. This manual is considered a permanent fixture with this machine. In the event of resale, this manual should accompany the sprayer. If you do not understand any part of the manual or require additional information or service, contact the Hagie Customer Support Department:

Hagie Manufacturing Company  
721 Central Avenue West  
Box 273  
Clarion, Iowa 50525-0273  
(515) 532-2861

The following symbols, found throughout this manual, alert you to situations that could be potentially dangerous conditions to the operator, service personnel, or the equipment.



This symbol indicates a hazardous situation which, if not avoided, will result in death or serious injury.



This symbol indicates a potentially hazardous situation, which if not avoided, could result in death or injury.



This symbol indicates a potentially hazardous situation which, if not avoided, may result in minor or moderate injury. It may also be used to alert against unsafe practices.

# Table of Contents

---

Introduction .....	i-ii
Table of Contents .....	iii
Safety.....	05-1
Decals .....	10-1
Identification.....	15-1
Specifications.....	20-1
Operator's Station.....	25-1
MD3 Operating Instructions.....	30-1
Hydrostatic System.....	35-1
Hydraulic System.....	40-1
Spray System .....	45-1
Foam Marker System .....	50-1
Quick-Tach System .....	55-1
All Wheel Steer .....	60-1
Reversible Fan.....	61-1
CE (Conforming European) Safety Features.....	62-1
Raven Spray Control Console .....	65-1
Transporting.....	70-1
Service Intervals .....	75-1
Service: Fluids .....	80-1
Service: Filters .....	85-1
Service: Lubrication .....	90-1
Service: Electrical System .....	95-1
Service: Belts.....	100-1
Service: Bolt Torque .....	105-1
Service: Toe-In .....	110-1
Service: Misc. ....	115-1
Storage .....	120-1
Troubleshooting .....	125-1
Warranty .....	130-1
Index .....	135-1

# SAFETY

Most accidents occur as the result of failure to follow simple and fundamental safety rules. For this reason, most accidents can be prevented by recognizing the real cause and doing something about it before the accident occurs.

Many conditions cannot be completely safeguarded against without interfering with efficient operation and/or reasonable accessibility. Therefore, you must study this Operator's Manual and learn how to use the sprayer controls for safe operation. Likewise, do not let anyone operate without instruction.

Do not make modifications such as weldments, add-ons, adaptations, or changes from the original design of sprayer. Such changes and/or modifications may become safety hazards to you and to others and will void all warranties.

If you have All Wheel Steer installed on your machine, pay special attention to instructions, components, and safety warnings marked with "▲".

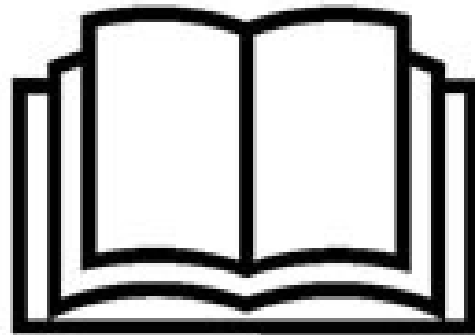

Replace missing, faded, or damaged safety signs. See the operator's manual for correct sign and placement.



# SAFETY

## Do Not By-Pass Safety Start Switch

- Start the machine from the operator's seat only. The machine must be in neutral to start.

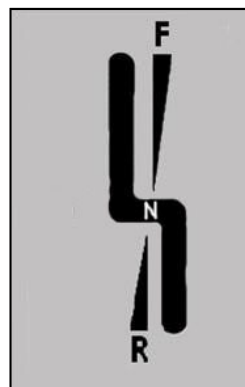

## Use Caution While Driving <sup>▲</sup>

- Never drive too close to ditches, embankments, holes, mounds or other obstacles.
- Never drive on hills too steep for safe operation.
- Reduce the sprayer speed while turning.
- Do not permit passengers on machine when it is moving; they may fall off or obstruct the operator's view.

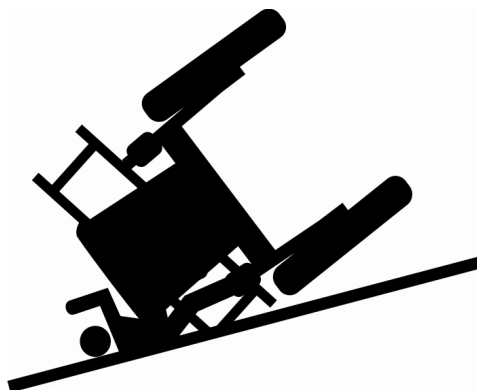

## Keep Riders Off Machine

- Do not permit passengers to ride on the machine or in the cab. The only time passengers should be permitted is for instructional or diagnostic purposes. The passenger should be seated on the buddy seat next to the operator and never allowed to ride outside of the cab.

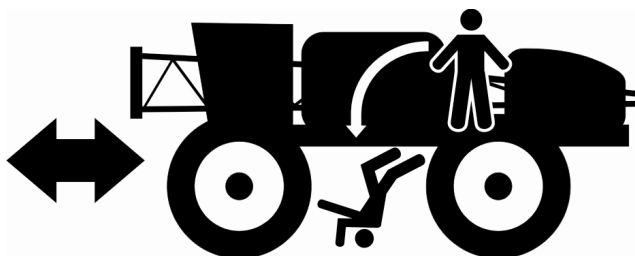

<sup>▲</sup> Operators with machines equipped with All Wheel Steer pay special attention!

# SAFETY

## Remove Paint Before Welding or Heating

### Heating

- Avoid potentially toxic fumes and dust. Hazardous fumes can be generated when paint is heated by welding, soldering, or using a torch.
- Do not use chlorinated solvents in areas where welding will take place.
- Do all work in an area that is well ventilated to carry toxic fumes and dust away.
- Dispose of paint and solvents properly.



## Avoid Heating Near Pressurized Lines

- Avoid torching, welding, and soldering near pressurized hydraulic lines. Pressurized lines may accidentally burst when heat goes beyond the immediate flame area.

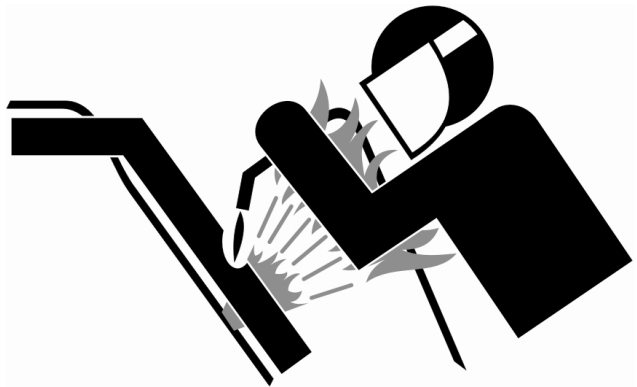

## Handle Fuel Safely– Avoid Fires

- Always turn engine off and allow it to cool before re-fueling.
- Never smoke while re-fueling.
- Do not fill tank completely, fuel may expand and run over.
- Always clean up spilled fuel with soapy water.
- Keep a fire extinguisher close when re-fueling.





# SAFETY

## Operate Safely

- Before moving sprayer, make sure there are no obstacles or persons in the path of travel.
- Never operate a machine in the same field as walking personnel.
- Always drive at a reasonable field speed.
- Never operate sprayer on roadway with any solution in the tank. Additional weight caused from partially full or full solution tanks may cause erratic or increased stopping distance.
- Never operate the sprayer at transport speeds with a full tank. The wheel motors and planetary gear hubs are not rated to withstand high speeds under full loads and may over heat or blow out.
- Pull over to the side of the road before stopping.
- Always come to a complete stop before reversing directions.
- Keep a fire extinguisher close at all times.
- Keep all shields in place.
- Keep clear of all moving parts and keep others away when operating.
- Do not wear loose fitting clothing that may be blown or drawn into moving parts.
- Do not activate parking brake while machine is in motion.
- Stop slowly to avoid “nose diving”.
- Reduce speed for icy, wet, graveled or soft roadway surfaces. ▲
- Use flashers/hazard warning lights, day or night, unless prohibited by law.



- Make sure SMV and SIS emblem is in place and visible from rear when traveling on public roadways.

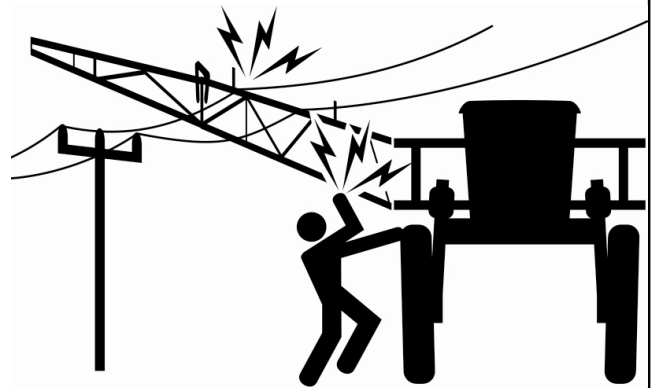

- Keep away from overhead power lines. Serious injury or death to you or others may result should the machine contact electrical wires.
- Do not adjust factory engine RPM settings.
- Operate engine at one bump to assure proper charge pressure for brakes to work properly.
- Never use starting fluid to assist engine start up.
- If equipped with ground speed sensing radar or light sensing depth units, do not look directly into radar beam. It emits a very low intensity microwave signal which may cause possible eye damage.

▲ Operators with machines equipped with All Wheel Steer pay special attention!

# SAFETY

## Be Prepared

- Be prepared for an emergency. Keep a fire extinguisher handy. Keep a first aid kit and clean water in the cab also.
- Make sure to service the fire extinguisher regularly. Keep an accurate inventory of supplies in the first aid kit and dispose of anything that has expired.

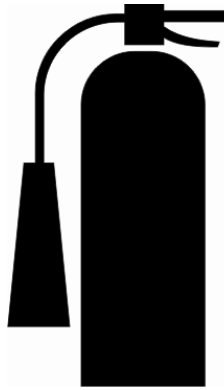

## Wear Protective Clothing

- Do not wear loose fitting clothes that could get caught in moving parts. Wear safety equipment that is appropriate for the job.
- Do not store chemical soaked clothes in the cab. Clean off as much mud and dirt from your shoes as you can before entering the cab.

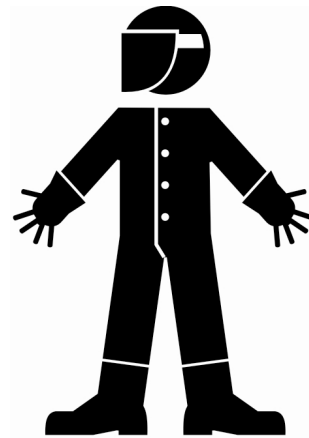

## Protect Against Noise

- Operating equipment safely requires the full attention of the operator. Do not wear radio or music headphones while operating the machine.
- Prolonged exposure to loud noise could cause loss of hearing. Wear suitable hearing protection.



# SAFETY

## Battery Acid Accident Prevention

Avoid serious injury by avoiding battery acid contact with your body. Battery electrolyte contains sulfuric acid that is strong enough to eat holes in clothing and cause blindness if splashed into eyes.

Make sure to:

- Fill batteries in a well ventilated area.
- Wear Personal Protective Equipment when servicing a battery.
- Avoid breathing in the fumes when recharging with electrolyte.
- Avoid spilling or dripping electrolyte.
- When charging a battery, connect positive cable to positive terminal and negative cable to negative terminal. Failure to do so may result in an explosion and cause injury.

If you spill on yourself:

- Immediately begin flushing affected area with cold water while removing any contaminated clothing and shoes. Continue to flush the area for a minimum of 15 minutes.
- Call a physician.
- While transporting or waiting for medical attention, apply compresses of iced water or immerse affected area in iced water. Do not allow tissue to freeze.
- Do not apply creams or ointments until you have been seen by a physician.

If acid is swallowed:

- Do not induce vomiting.

- Drink large amounts of water.
- Get medical attention immediately!
- Do not neutralize the acid.

If fumes are inhaled:

- Move the person into fresh air.
- Do not give artificial respiration to a person that is able to breathe on their own.
- Give CPR only if there is no breathing AND no pulse.
- Seek medical attention IMMEDIATELY!



# SAFETY

## Handle Agricultural Chemicals Safely

Agricultural chemicals used in applications can be harmful to your health and the environment if not used carefully.

- Always follow the manufacturer's label directions for use.
- Never allow chemicals to come in contact with your skin or eyes.
- Never pour chemicals into an empty tank, fill tank half full of water first.
- Dispose of empty chemical containers properly.
- Wash spilled chemicals or spray residue from the sprayer to prevent corrosion and deterioration.
- Select a safe area to fill, flush, calibrate, and clean sprayer where chemicals will not run off to contaminate people, animals, vegetation, or water supply.
- Never place a spray nozzle to your lips in an attempt to unclog it.
- Do not spray when wind is in excess of chemical manufacturer's recommendation.
- Store chemicals in their original containers with the label intact.
- Store chemicals in a separate, locked building.
- Wear protective equipment as recommended by chemical manufacturer.

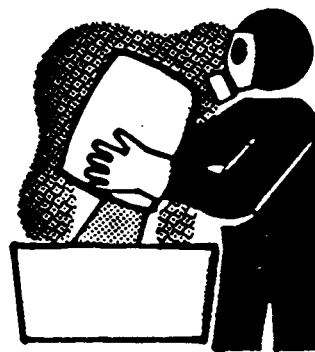
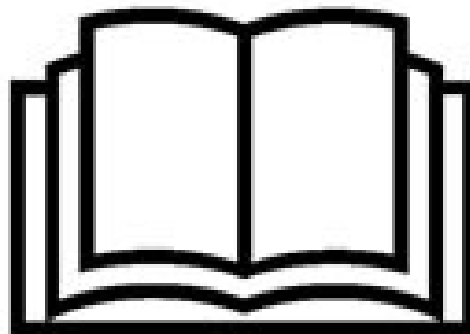

# SAFETY

## Safe Hydraulic Maintenance

- Always practice personal safety when performing service or maintenance on the hydraulic system.
- Use caution when working with hydraulic fluid under pressure. Escaping fluid can have sufficient force to penetrate your skin causing serious injury. This fluid may also be hot enough to burn.
- Always lower the load or relieve the pressure before repairing a hydraulic oil leak.

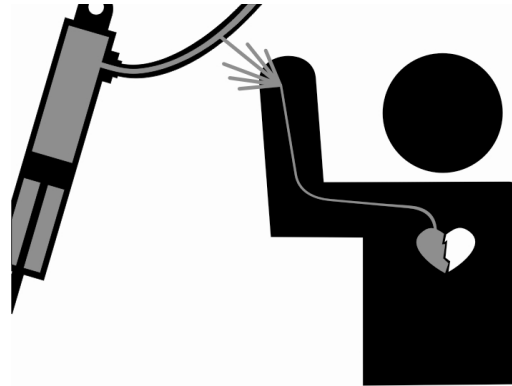

## Beware of Exhaust Fumes

- Never run the machine in a closed building. Proper ventilation is required. Use an exhaust pipe extension to remove fumes if you must operate in a building. Also open doors and windows to bring in enough outside air into the area.

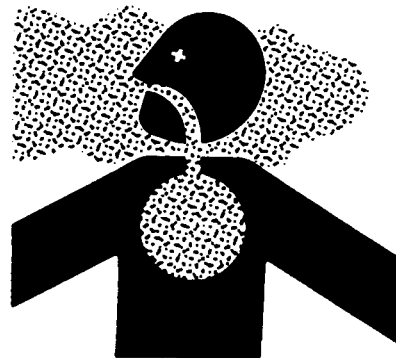

# SAFETY

## General Maintenance Safety

- Turn off engine before checking, adjusting, repairing, lubricating, or cleaning any part of the sprayer.
- When servicing the radiator, let the engine cool before removing pressurized cap.
- Disconnect battery ground cable and turn main battery switch off before servicing electrical system or welding on machine.
- Each Hagie machine outfitted with AWS has position sensing internal to the steering cylinders. Please disconnect each sensor before welding on the machine. Then re-connect when done welding. ▲



## Operating Optional Components

### Tread Width

- Select a tread setting to fit between crop rows.

### Sprayer Booms

- Cradle booms when leaving sprayer unattended.
- Make sure booms are folded when cradled.
- Select a safe area before unfolding booms. Avoid power lines and overhead structures.

### Outriggers

- Make sure the outriggers are locked when folded in or out.
- Fold the outriggers before traveling on a public roadway.

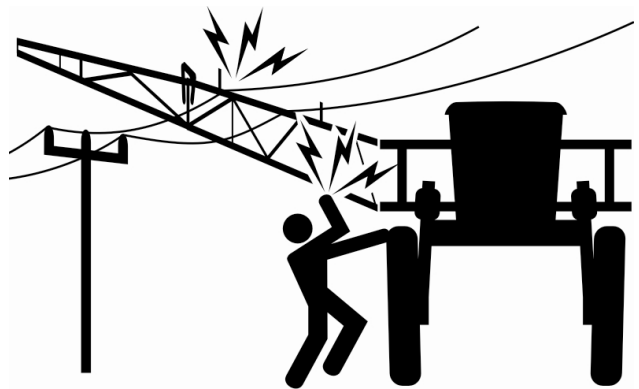

▲ Operators with machines equipped with All Wheel Steer pay special attention!

# SAFETY

## All Wheel Steer Safety ▲

Many of the precautions listed below are repetitive to the precautions for a standard machine. It is very important that they receive special consideration. Failure to obey the precautions and operating instructions regarding the ALL WHEEL STEER system will result in serious injury or death and machine damage.

- Make sure that you understand how to operate the machine with the standard set-up (conventional steering only). You will need to get a feel for how the drive system works by sitting behind the wheel and driving the machine.
- It is very important to understand all of the aspects that are related to the ALL WHEEL STEER system. You will need to know how to turn the system on or off and understand when the system will limit itself or even turn itself off. You will also want to understand the graphics and tools that will help you maintain your system operating to your liking.
- REDUCE SPRAYER SPEED BEFORE TURNING .
- NEVER DRIVE ON HILLS TOO STEEP FOR SAFE OPERATION.
- NEVER DRIVE NEAR DITCHES, EMBANKMENTS, HOLES, OR OTHER SIMILAR OBSTACLES.
- COME TO A COMPLETE STOP BEFORE REVERSING DIRECTION.
- ALWAYS DRIVE AT A REASONABLE FIELD SPEED.

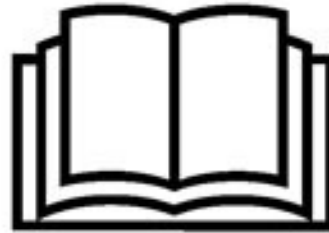

▲ Operators with machines equipped with All Wheel Steer pay special attention!

# DECALS

## WARNING DECALS

Decals warning you of avoidable danger are located on various parts of the sprayer. They are there for your personal safety and protection. DO NOT remove them. They will fracture upon attempted removal and therefore must be replaced.

Following are locations of important safety decals. Replace them if they are torn or missing. All warning decals and other instructional Hagie decals or machine striping may be purchased through Hagie Customer Support Department. To replace decals, be sure the installation area is clean and dry; decide on exact position before you remove the backing paper.



## DECAL LOCATION

### 650107

Rear of frame around the booster terminals.





# DECALS

650118

On engine compartment in front of air cleaner.



650164

Left hand rear cab post.



# DECALS

650165

Right hand rear cab post.

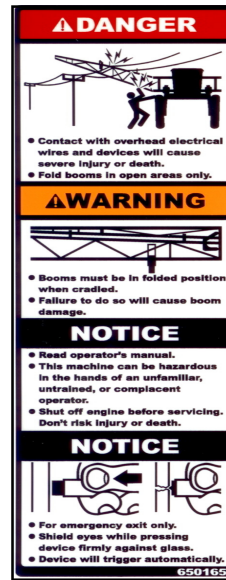

650174

In engine compartment, on top of radiator.



650176

Right hand window near rear cab post.

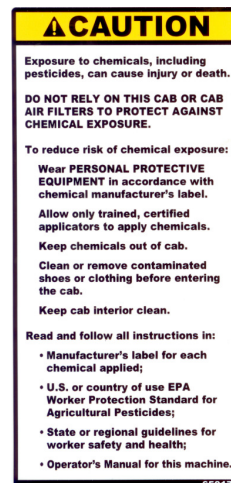
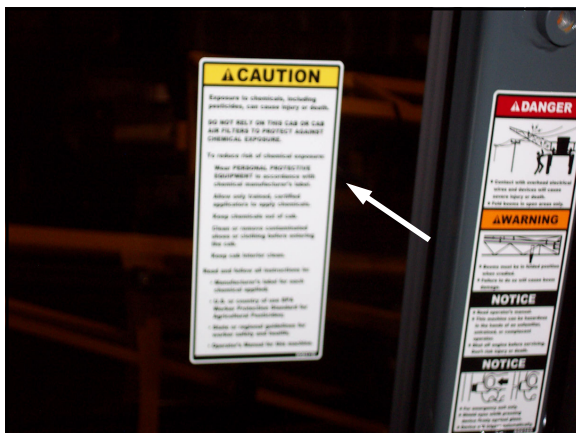

# DECALS

650178

Quick attach mount.



650339

Front cross member: left hand side (1)

Hydraulic reservoir: left of the sight gauge (2)

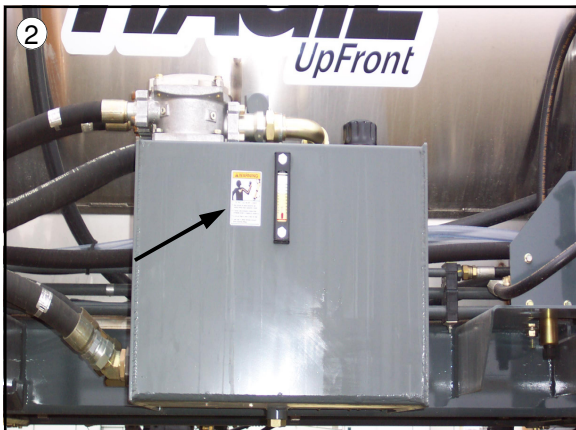

# DECALS

650848

On ladder pivot tube.



650849

On engine compartment, near fuel cell cap.

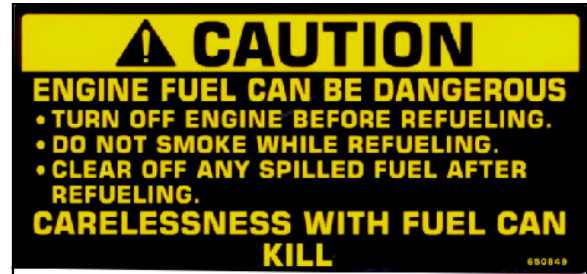

# DECALS

650850

Front fill– on solution tank near fill lid (1).

Side fill– on educator tank lid (2).

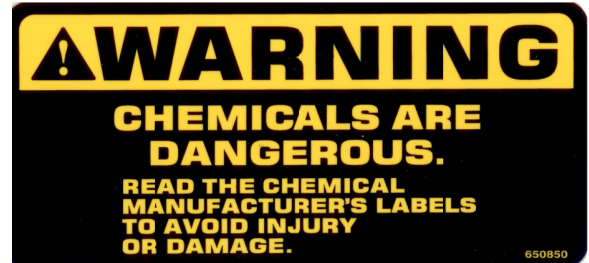

650851

Left side rear mainframe, near ladder.



# DECALS

650981

In engine compartment, near radiator cap.



650982

On fuel cell near batteries.

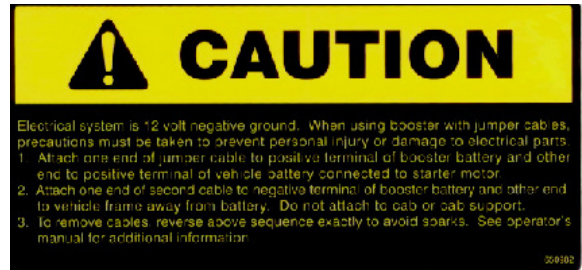

# IDENTIFICATION

Each Hagie sprayer is identified by means of a frame serial number. This serial number denotes the model, year in which it was built, and the number of the sprayer. For further identification, the engine has a serial number, the hydrostatic pumps have serial numbers, and the planetary hubs have identification plates that describe the type of mount and gear ratio.

To ensure prompt, efficient service when ordering parts or requesting service repairs from Hagie Manufacturing Company, record the serial numbers and identification numbers in the spaces provided below.

## NOTICE

*Reference to right hand and left hand used throughout this manual refers to the position when seated in the operator's seat facing forward.*

### Sprayer

The sprayer serial number is stamped in the frame on the right rear corner.

\_\_\_\_\_

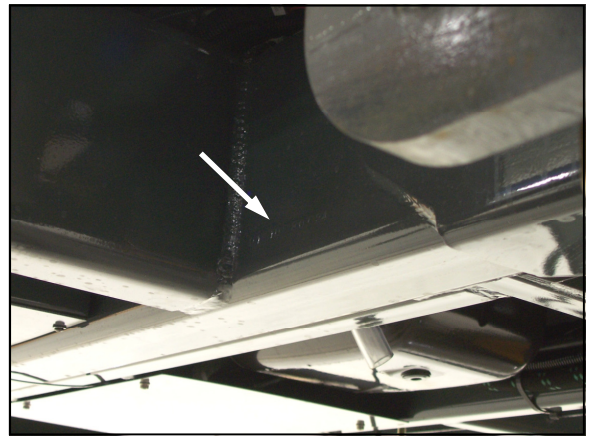

### Engine

The diesel engine serial number is located on the engine block valve cover.

\_\_\_\_\_

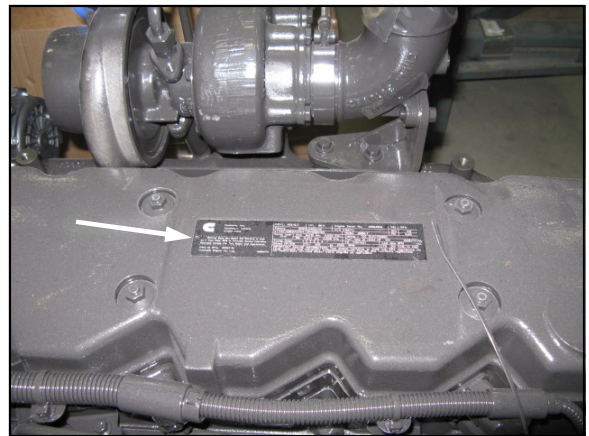

# IDENTIFICATION

## Wheel Hubs

Each wheel hub has an identification plate attached to the front of it. The plate also contains information regarding gear ratio.

- \_\_\_\_\_ Right Front
- \_\_\_\_\_ Right Rear
- \_\_\_\_\_ Left Front
- \_\_\_\_\_ Left Rear

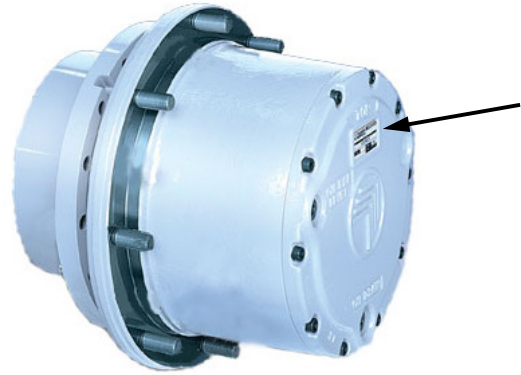

## Hydrostatic Pumps

The engine has two hydrostatic pumps stacked on the engine block. Refer to the Hagie Parts Manual for Hagie part number.

- \_\_\_\_\_ Front
- \_\_\_\_\_ Rear

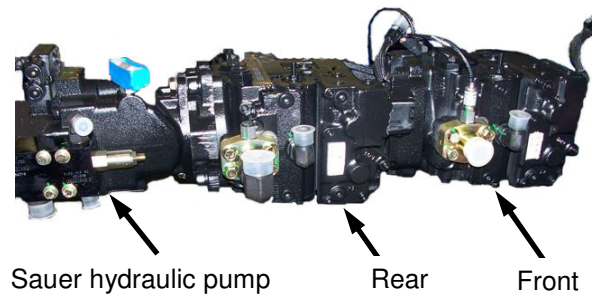

## Wheel Motors

The wheel motors each have an identification plate permanently attached to it. The identification plate contains the serial number and other manufacturer information. Refer to Hagie Parts Manual for Hagie part number.

- \_\_\_\_\_ Right Front
- \_\_\_\_\_ Right Rear
- \_\_\_\_\_ Left Front
- \_\_\_\_\_ Left Rear





# SPECIFICATIONS

## SPRAYER DIMENSIONS\*\*

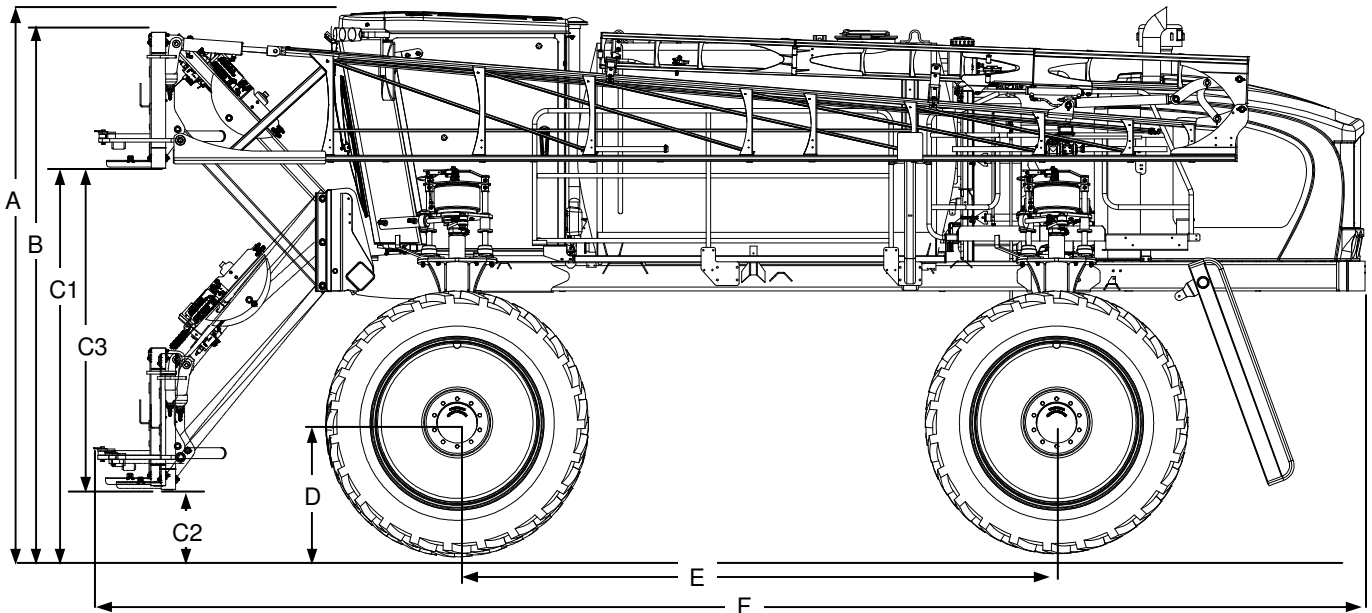

DET	DESCRIPTION	SPEC
A	Overall tractor height	149"
B	Raised transom height	142.5"
C3	Transom lift range (C1 minus C2)	85" (108"-22")
D	Static loaded hub height	33.5"
E	Wheel base	166"
F	Sprayer length	344"
G	Width (booms folded, 120" tread)	143"
H	Frame clearance	72"
I	Lower leg clearance (from shield)	27"
J	Tire center to inside of shield	13.5"
K	Tread width* (non-hydraulic tread) Adjustable hydraulic tread (option)	120" 120"-152"

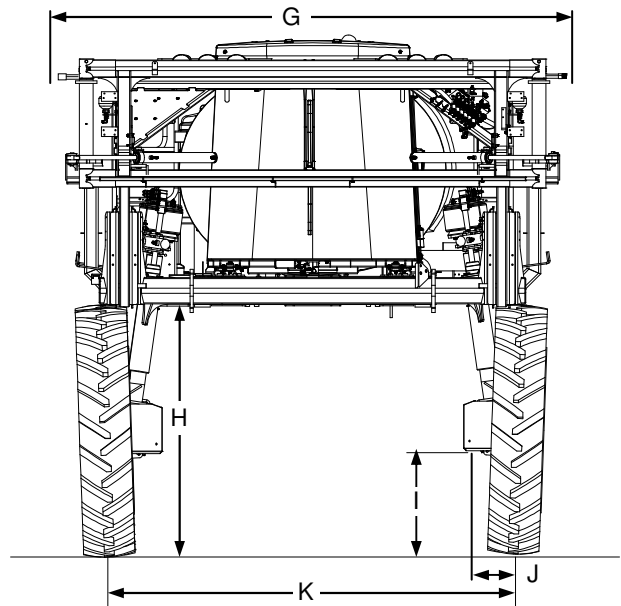

### General Sprayer Information

- Frame type ..... 4x8" modular platform frame
- Suspension.....4-wheel, individual, auto air-ride
- Approximate dry weight ..... 24,240 lbs.
- Shipping width.....143"

\*tread width is measured at 1/2 the tire height  
 \*\* may vary with tire option

NOTICE

Because Hagie Manufacturing offers a variety of options, the illustrations in this manual may show a machine equipped other than standard.

Weight and height do not consider options, values may be different depending on options.

# SPECIFICATIONS

ITEM	SPECIFICATION
<b>ENGINE</b>	
Manufacturer	Cummins
Model	QSB6.7
Type	Electronic with air to air cooler and turbo charger
Number of Cylinders	6
Displacement	6.7 liter (360 c.i.)
Horse Power	275 hp (205 KW)
Type of Fuel	Number 1 or Number 2 diesel
Fuel System	Filtered, direct-injected
Air Cleaner	Dry-type, single element
Engine Air Filter Restriction Monitors	Filter Minder®
Slow Idle	850 RPM
Fast Idle (no load)	2500 RPM
<b>HYDROSTATIC DRIVE</b>	
Hydrostatic Pump	Sauer-Danfoss Tandem 90 series
Displacement	150 cc (75x2) with electronic displacement control
Drive Train	All-wheel four wheel drive
Speed ranges ▲	4 in field state 5 in road state
Hydrostatic Wheel Motors	Sauer-Danfoss (90 Series)
Final Drives	Planetary gear reduction hubs
• Front	Bonfiglioli hubs w/brake (22:1)
• Rear	Bonfiglioli hubs w/brake (30:1)
• Lubrication	Oil Bath
Brakes (Parking Only)	Multiple disc, spring applied, hydraulically released
Steering System	Hydraulic, dedicated circuit
• Control	Full time power
• Steering Cylinders	Self-centering, double action
• Turning Radius	22.5 ft
All Wheel Steer (optional) ▲	Coordinated Steering

Filter Minder is a registered trademark of Engineered Products Company

▲ Operators with machines equipped with All Wheel Steer pay special attention!

# SPECIFICATIONS

ITEM	SPECIFICATION
<b>AUXILIARY HYDRAULIC SYSTEM</b>	
Type	Single closed center pump
Pump Type	Load sense
<b>SPRAY SYSTEM</b>	
Booms	60/80/90/100ft. (5 sections) optional 90/120ft. (9 spray sections)
• Type	Dry with variable row spacing (optional wet)
• Controls	Electro-hydraulic (fold, lift, level)
• Level Shock Absorber	Gas charged accumulator
• Outer Boom Hydraulic Breakaway	Self-actuated, auto-reset hydraulic
Solution Fill Connection	
• Quick-fill Connection	3 in. (7.6 cm) inner diameter
Solution Tank	
• Standard	1400 gal. (5299L) stainless steel
Agitation	
• Stainless Steel Tank	Sparge-type w/ electric variable speed control
General Spray System	
• Pump	Centrifugal– hydraulically driven with pulse width modulated control valve
• Solution Valves	Electric ball valves
• Pressure Gauge	100 PSI glycerin filled
• Console	Raven 4600 (GPS ready)
• Fence Row Nozzle	Two-position, remote activated

# SPECIFICATIONS

ITEM	SPECIFICATION
<b>FOAM MARKING SYSTEM</b>	
Make	Hagie Foam Marker
Type	Live air
<b>RINSE SYSTEM</b>	
Spray System Rinse (solution tanks, pump, and booms)	Standard
High Pressure Washing System	Optional

# SPECIFICATIONS

ITEM	SPECIFICATION
<b>ELECTRICAL SYSTEM</b>	
<b>General Electrical System</b>	
• Battery	Dual 12V, negative ground
• Alternator	160 AMP, voltage regulated
• Starter	12V with solenoid
<b>Circuit Breakers/Fuses</b>	
<b>Fuse Module 1</b>	
• MD3 Module	3 AMP (1)
• Console lights, field lights, work lights, console switch power, control handle	5 AMP (4)
• Road lights, ignition, hazard lights, horn, seat air pump, radio power	10 AMP (3)
• Power port 1, HVAC control, wiper/washer, switch power to power connectors (1, 2, 3), switch power to power point 2, boom lights	15 AMP (6)
• Battery power to power connectors (1, 2, 3), Raven monitor, cab module 1 (XS2-A0), cab module 2 (XS2-A1), boom spray valve 1	20 AMP (5)
• HVAC fan-high	25 AMP (1)
<b>Fuse Module 2</b>	
• Ignition ON, radio memory, RTC battery	5 AMP (2)
• Diagnostic plug, solution pump valve	10 AMP (2)
• Field lights relays (1, 2, 3), boom spray valve 2, Norac (if equipped), switch power to power connectors (4, 5, 6)	15 AMP (7)
• Battery power to connectors (4, 5, 6), chassis module #1 (XT2-A0), chassis module #2 (XA2-A0), chassis module #3 (XS2-A2), 90' boom implement module #1* (XA2-A1), 90' boom implement module #2* (XS2-A4), 90' boom implement module #3* (XS2-A5), NTB (if equipped) implement module #4* (XA2-A3)	20 AMP (8)

\* if the machine is equipped with the 120' boom the implement module will be replaced as follows: module #1, XA2-A3; module #2, XS2-A4; module #3, XS2-A5; module #4, XA2-A4.

# SPECIFICATIONS

ITEM	SPECIFICATION
Relay Module 1	
<ul style="list-style-type: none"> <li>Ignition ON, start interlock, fan high, start switch signal, start relay control signal, high fan relay output, high fan relay control signal, field lights relay out, RM1 ground wire, relay control jumper, console light, spare (1)</li> </ul>	12V micro relays
Relay Module 2	
<ul style="list-style-type: none"> <li>RM2 ground wire, field lights #1 and #2 relay out, field lights control signal, field lights relay power, spare (4)</li> </ul>	12V micro relays
Engine Electrical Box	
Fuses	15 AMP (3), 20 AMP (1), 30 AMP (1), 125 AMP (2)
Relays	
<ul style="list-style-type: none"> <li>Start, Auxiliary</li> </ul>	12V/ 40 AMP (2)
<ul style="list-style-type: none"> <li>Intake heater 1 and 2</li> </ul>	12 V micro (2)
Circuit Breaker	
<ul style="list-style-type: none"> <li>Main Breaker</li> </ul>	120 AMP (1)
Other Fuses and Relays	
Flasher/light Harness	12V flasher relay, 15 AMP fuse (6), 40 AMP relay (5)
90' Boom Harness	30 AMP fuse
Lights	
Front of Cab	2 Trapezoidal head lights, 4 flood lights
Transom	2 Trapezoidal head lights
Transom Mount	2 Trapezoidal head lights
Boom Cradle (forward facing)	2 Trapezoidal flood lights (1 each cradle)
Boom Cradle (rear facing)	2 Trapezoidal flood lights (1 each cradle), 2 Oval amber lights (1 each cradled)
Rear Engine Hood	2 Round red lights, 2 round amber lights
Transom (boom indicators)	1 Oval white LED, 2 oval amber LED, 5 oval red LED (10 if equipped with 120' boom)

▲ Operators with machines equipped with All Wheel Steer pay special attention!

# SPECIFICATIONS

ITEM	SPECIFICATION
<b>CAB AND INSTRUMENTS</b>	
<b>Cab</b>	
General Cab	Tilt steering, windshield wiper/ washer, dual side mirrors, dome light, tinted glass, training seat
Temperature Control	Full range
A/C Charge Type	R-134a
Fresh Air Filtration	Paper and charcoal filter
Seat	Air ride
<b>Instruments</b>	
MD3	Hour meter, fuel, water temperature, battery voltage, engine oil pressure, ground speed, engine RPM, tread adjust assist
Stereo	AM/FM/WB with CD
<b>CAPACITIES</b>	
Solution Tank	1400 gallons (5299.58 L)
Fuel Cell	150 gallons (530 L)
Cooling System (including block, lines, and radiator)	18 gallons (68 L)
Hydraulic Oil (including tank, filter, and cooler)	55 gallons (208 L)
Rinse System Tank	100 gallons (379 L)
Foam Marker	36 gallons (136 L)
Engine Oil (including crankcase, lines, filter, and cooler)	17 quarts (16 L)
Wheel Hubs (front and rear)	40 ounces (1.18 L)

# SPECIFICATIONS

ITEM	SPECIFICATION
<b>TIRES</b>	
<b>Standard</b>	
380/90R46	Radial TU
• Load Rating	168A8/B
• Air pressure	Inflate tires to max pressure indicated on tire sidewall
• Tread Width	15.2 in. (38.61 cm)
• Load Capacity *	12300 lbs. (5579.19kg)
• Overall Diameter	73.0 in. (185.42 cm)
• Static Load Radius **	31.5 in. (80.01 cm)
• Rolling Circumference	217.2 in. (551.69 cm)
<b>Optional</b>	
380/90R54	Radial TU
• Load Rating	170A8/B
• Air Pressure	Inflate tires to max pressure indicated on tire sidewall
• Tread Width	15.0 in. (38.10 cm)
• Load Capacity *	13200 lbs. (5987.42 kg)
• Overall Diameter	80.4 in. (204.22 cm)
• Static Load Radius **	37.3 in. (94.74 cm)
• Rolling Circumference	243.0 in. (617.22 cm)
320/90R50	Radial TU
• Load Rating	161A8/B
• Air pressure	Inflate tires to max pressure indicated on tire sidewall
• Tread Width	12.6 in. (32.0 cm)
• Load Capacity *	10200 lbs. (4626.64 kg)
• Overall Diameter	72.6 in. (184.40 cm)
• Static Load Radius **	33.8 in. (85.85 cm)
• Rolling Circumference	219.0 in. (556.26 cm)
320/105R54	Radial TU
• Load Rating	166A8/B
• Air pressure	Inflate tires to max pressure indicated on tire sidewall
• Tread Width	13.6 in. (34.54 cm)
• Load Capacity *	11700 lbs. (5307.03 kg)
• Overall Diameter	80.3 in. (203.96 cm)
• Static Load Radius **	37.7 in. (95.76 cm)
• Rolling Circumference	239.0 in. (607.06 cm)

\* Load capacity measured at 30 mph (48.28 km/h) unless otherwise specified

\*\* Static load radius is suggested and will vary with load.



# SPECIFICATIONS

ITEM	SPECIFICATION
<b>TIRES</b>	
Optional	
520/85R46	Radial TU
• Load Rating	158A8/B
• Air Pressure	Inflate tires to max pressure indicated on tire sidewall
• Tread Width	21.3 in. (54.10 cm)
• Load Capacity *	9350 lbs. (4241.09 kg)
• Overall Diameter	80.6 in. (205.23 cm)
• Static Load Radius **	37.0 in. (93.99 cm)
• Rolling Circumference	243.0 in. (617.22 cm)

\* Load capacity measured at 30 mph (48.28 km/h) unless otherwise specified

\*\* Static load radius is suggested and will vary with load.

# OPERATOR'S STATION

## Front Console

- A. Hazard/warning light switch
- B. Highway lights, running light switch
- C. Steering wheel
- D. Turn signal indicator light
- E. Horn
- F. Turn signal switch
- G. Ignition switch
- H. Steering wheel tilt adjust
- I. Steering column release pedal

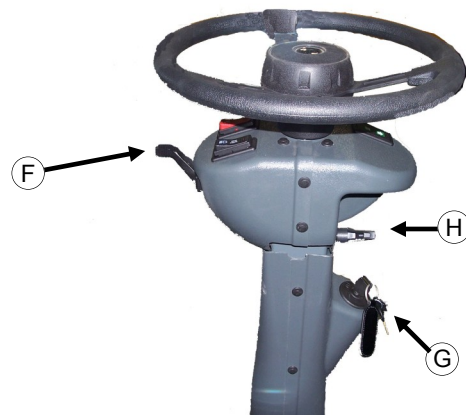

# OPERATOR'S STATION

## Hazard/ Warning Lights

To activate the hazard/ warning lights (A, B, E) depress the FLASHER switch. Use the hazard/ warning lights anytime, day or night, that you are traveling on a public roadway unless prohibited by law.

## Highway/ Running Lights

The highway/ running lights are mounted on the transom (D) and on the transom mounts (C). Use these trapezoid headlamps when traveling on a public roadway at night. Turn them on using the highway/ running light switch located on the front console.

Activating the highway lights will also turn on the red running lights on the rear of the machine (F).

The ignition does not have to be on to operate these lights. Prolonged use of these lights without the engine running is not recommended.

## Turn Signals

To activate the front turn signals (A) and the rear turn signals (B, E), move the turn signal lever forward, away from the operator, to signal a right turn and back, toward the operator, to signal a left turn.

Steering column mounted indicator lights will correspondingly flash when either turn signal is activated.

The turn signal switch is not self-centering and must be manually returned to the OFF position after completing your turn.

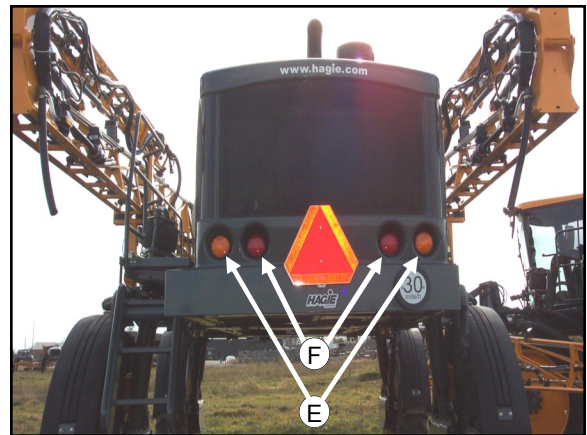

# OPERATOR'S STATION

## Ignition Switch

The ignition switch has three positions. The first position is the OFF position. The second position is referred to throughout this manual as the ON position and the last position is the START position.

Before engaging the starter, turn the key to the ON position and wait for the "wait to start" light on the message center to go off.

To engage the starter, turn the key to the START position and hold momentarily until the engine engages. If the engine does not engage after 15 seconds, turn the key to OFF. Constant cranking of the starter when an engine fails to engage will cause damage to the battery and the starting system. Refer to the section on the hydrostatic drive for more information.



## Horn

The horn is a push button located on the front console below the turn signal indicator lights.



# OPERATOR'S STATION

## Tilt Adjust Handle

The steering wheel tilt adjust handle is for the movement of the upper portion of the steering column only. The steering wheel has infinite position possibilities.

To use the adjustment handle, turn it down (toward the operator) to loosen it. You do not need to remove the handle all the way, simply loosen it enough to freely move the steering wheel.

With the handle loosened, push or pull on the steering wheel until it is in a comfortable position. Hold the steering wheel in that position while tightening the adjustment handle. To tighten the handle, turn it upward (away from the operator).

①



②



## Steering Column Release Pedal

The steering column release pedal is for easy exit/ entry of the cab. Push the pedal to release the locking gas spring. With the spring released, you can smoothly move the entire steering column forward or rearward.

To lock the column in place, simply remove your foot from the pedal while holding the column in place. Once the gas spring has been locked again, check the column by firmly trying to move the column in either direction.



## NOTICE

Be sure that the steering wheel and column are locked into place before trying to move the machine. Failure to do so will make it difficult to maintain control of the machine.

# OPERATOR'S STATION

## Side Console

- A. Speed control
- B. Throttle switch
- C. Brake/ ladder switch
- D. Agitation switch
- E. Solution tank switch
- F. Rinse tank switch
- G. Boom extension switch
- H. Tread adjust switches
- I. Boom spray section switches
- J. Fence row nozzle switch
- K. Power ports
- L. Warning buzzer
- M. Hagie diagnostic port
- N. Engine diagnostic port
- O. Hydrostatic lever
- P. Foam marker switch
- Q. Hydraulic lift
- R. Left boom (level, horizontal extension)
- S. Right boom (level, horizontal extension)
- T. Master spray switch ON
- U. Speed range switches

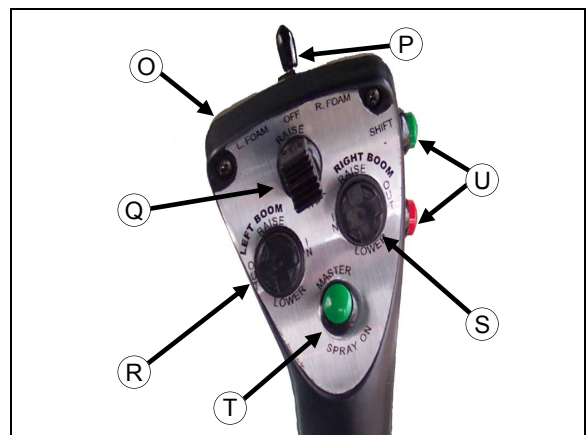
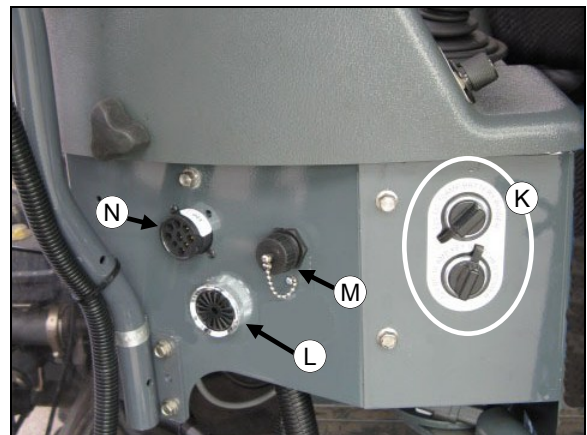
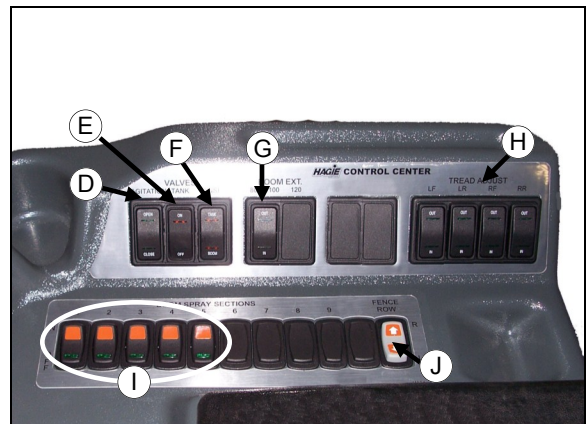

# OPERATOR'S STATION

## Hydrostatic Lever

The hydrostatic lever is used to control the direction of motion of the machine and the speed at which it travels. It is a part of the ACE hydrostatic system or the Automatically Controlled Engine hydrostatic drive. To learn more about the ACE system, refer to the section on the hydrostatic drive system.

The lever also houses controls for the spray system and foam marking system. For more information on these controls, refer to the section on the spray system.



## Speed Control

Another feature of the hydrostatic drive system is the speed control. This feature will help the operator to regain consistent field speeds when re-entering a field from the end rows.

The speed control will maintain its setting until you reset it. It does not have to be re-set each time you turn off the machine.

For more information on how to use the speed control feature, refer to the section on the hydrostatic drive system.



# OPERATOR'S STATION

## Throttle Switch

The throttle switch (A) is used to control engine speed (RPM) between 850 and 2500 RPM. The switch works with a timer to tell the engine how fast to turn. The longer the operator holds the switch in either direction, the more the engine will speed up or slow down. (Note that this is not the only way the engine receives this information, refer to the section on ACE. )

The buttons on the side of the hydrostatic lever (B) are to control the speed ranges within the RPM setting. For more information on the throttle controls, refer to the section on the hydrostatic drive system.



## Parking Brake

The parking brake switch is located next to the throttle switch on the side console. The switch also controls the ladder. The brake switch must be on to lower the ladder and to operate the side fill or pressure washer (if equipped).

The parking brake is not intended for normal or emergency stopping and will not engage if the machine is traveling over 1 mile per hour. Activating the brake while the machine is still moving is hazardous to the operator and the sprayer. Bring the sprayer to a complete stop with the hydrostatic lever in the neutral position before applying the parking brake.





# OPERATOR'S STATION

## Forward, Neutral, Reverse

The hydrostatic lever is used to determine the direction of motion of the machine. To move the machine forward, pull the lever slightly to the right and push forward. The farther you push, the faster the speed of the machine.

To stop the machine, or put the machine in neutral, slowly pull the lever back to the center position and move it slightly to the left. The neutral position must be met before changing direction of the machine. The machine must also be in neutral before several functions can be performed.

To move the machine in reverse, move the lever to the far right and slowly pull back. The farther back the lever is pulled, the faster the machine's speed.



# OPERATOR'S STATION

## Boom Solution Valve Switch

The solution valve switches (A) each control a valve located on the transom or the booms. The valves control the flow of solution through the boom. The boom is divided into 5 sections (3 on a 60 ft. boom), the far left tip being the beginning of the first section. More information is available in the spray systems section.

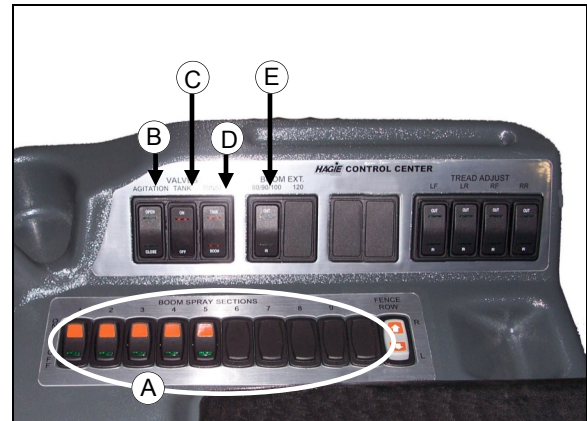

## Agitation Switch

The agitation switch (B) controls the rate of flow through the sparge system. For more information on the agitation system, refer to the section on the spray system.

## Tank Switch

The tank switch (C) controls the solution tank valve. This switch must be in the ON position to spray. For more information on the tank switch, refer to the section on the spray system.

## Rinse Switch

The rinse switch (D) is used when you wish to rinse the solution tank or the booms. For more information on how to use the rinse system, refer to the section on the rinse system.

## Boom Extension Switch

The boom extension switches (E) are used when vertically extending or retracting the booms. Refer to the section on the spray booms for more information.

continued on next page

# OPERATOR'S STATION

## Tread Adjust Switch

The tread adjust switches (A) are used to hydraulically adjust the tread width. These switches will not do anything if the machine is not equipped with hydraulic tread adjust. For more information on hydraulic tread adjustment, refer to the sections regarding tread adjust.



## Fence Row Switch

The fence row switch (B) is for the selection of right or left fence row spray nozzle. More information on fence row spraying can be found in the section on the spray system.

# OPERATOR'S STATION

## Power Ports

On the front side of the console there are two power ports for extra equipment to be plugged in. They are each protected by a 15 amp fuse. They are not intended for the permanent connection of extra systems to the sprayer. There is a terminal strip, inside the console, intended for the installation of extra radios and computer equipment. See your parts manual for electrical diagrams.

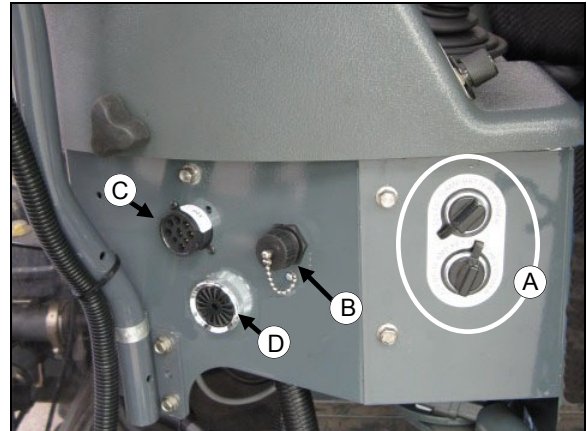

## Hagie Diagnostic Port

The Hagie diagnostic port (B) is located on the front rear panel of the side console. This port is for the use of a laptop to diagnose machine program errors and machine reprogramming. This port is to be used by Hagie service technicians only. DO NOT use this port to connect personal digital assistants (PDA's) or other personal electronic equipment.

## Engine Diagnostic Port

Much like the Hagie diagnostic port, the engine diagnostic port (C) is used to connect directly into the engine by Hagie service technicians or Cummins service technicians. DO NOT attempt to plug into this port with personal electronic equipment.

## Warning Buzzer

The warning buzzer (D) located on the front rear panel of the side console alerts the operator when there is an immediate need of attention for one of the machine's systems.

# OPERATOR'S STATION

## Foam Marker Switch

The foam marker switch (A) located on the top of the hydrostatic lever controls the foam option on both sides of the machine. See the section regarding the foam marking system for more information.

## Main Solution Switch

The main spray control (E) in the lower middle of the hydrostatic lever makes it so that the operator can turn all spray valves off at the same time. See the spray systems section for more information.

## Lift, Level, Horizontal Extension

The lift (B), level (C, D) and horizontal extension (C, D) are all hydraulic boom functions. A complete explanation of their operations can be found in the spray system section.

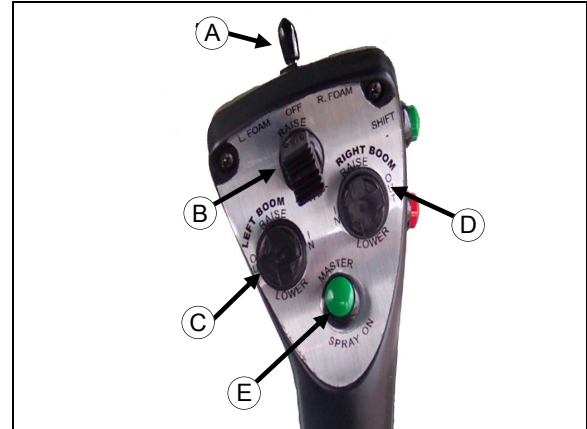

# OPERATOR'S STATION

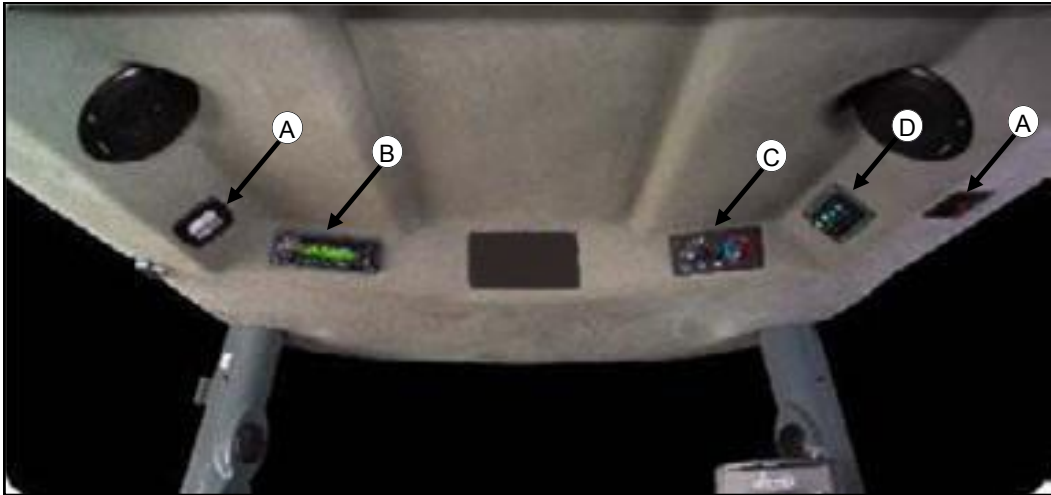

## Overhead Monitors and Controls

- A. Courtesy light/ interior work light
- B. Stereo
- C. Climate controls
- D. Wiper and lights switch panel
- E. Raven console
- F. MD3



# OPERATOR'S STATION

## Courtesy Light/ Interior Work Light

The courtesy light comes on when the cab door is opened.

The interior work light can be turned on manually by pushing on the right (front) or left (rear) edges of the lens.



## Stereo

The cab has an AM/FM/tuner with a CD player and Weather Band broadcasting. Refer to the stereo manufacturer's manual for operating and programming information.



# OPERATOR'S STATION

## Warning Indicator Message

The warning indicator message (A) will come on if there are any malfunctions or faults in the systems monitored by the MD3. These warnings include, but are not limited to: engine oil pressure, oil level, hydraulic oil level, coolant temperature, battery voltage, and fuel level. An explanation of the fault will appear on the screen. If a fault appears, shut the engine off immediately and resolve the fault before continuing. Failure to shut the engine off may result in damage to the system with the detected fault.





# OPERATOR'S STATION

## MD3

The MD3 (A) is the machine's control center. The MD3 takes the place of the conventional gauges. The MD3 can give you information on tread width, engine RPM, engine oil pressure, hour meter, fuel level, coolant temperature, tire size, battery voltage, speed range, and machine program version. The information can be viewed by using the different function keys to move through it. The MD3 will also display any faults found in the monitored systems.

Refer to the section on the MD3 for more information. Call Hagie Manufacturing Customer Service if you are unable to navigate the MD3 successfully.

## Spray System Indicator Light

The spray system indicator light (C) will illuminate when the main spray control on the hydrostatic lever (B) has been activated. If the light is not on, the spray system is not on.

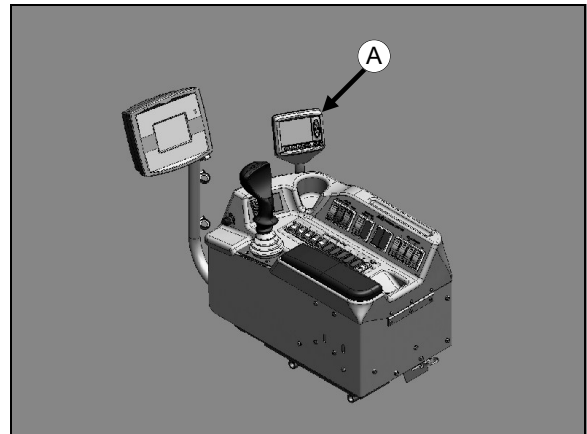

# OPERATOR'S STATION

## Climate Controls

The climate controls are continuous adjusting dial switches located on the front upper cab headliner.

Adjusting the Fan Blower Speed– fan blower speed is controlled by the left rotary dial (A). To increase the fan speed, rotate the dial clockwise. To reduce the fan speed, rotate the dial counterclockwise. To shut off, rotate the dial all the way counterclockwise.

Adjusting Temperature Setting– forced air temperature adjustments are controlled by the right rotary dial (B). Temperature control is a continuously variable adjustment. To increase the forced air temperature, rotate the dial clockwise. To decrease the forced air temperature, rotate the dial counterclockwise.

Operating the Air Conditioning– to activate the air conditioner, press the air conditioning switch (C). Adjust the fan speed and temperature accordingly. See the service section for more information.

## Vents

There are six adjustable vents (D), three on each front cab corner post. They may be adjusted by rotating them for desired direction, or individually turned on or off with the directional fins.

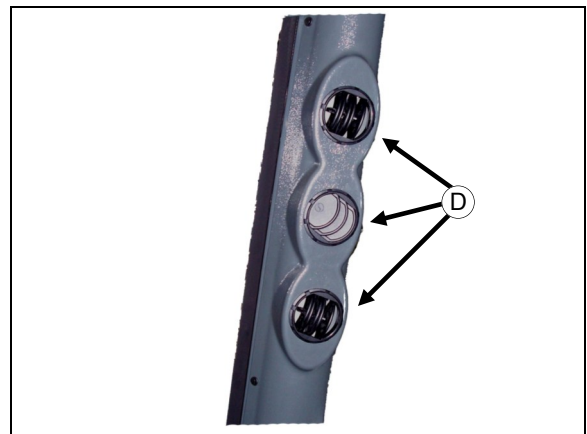
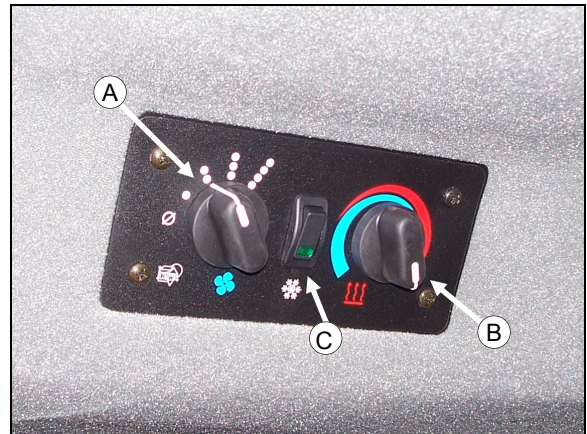

# OPERATOR'S STATION

## Windshield Wiper and Washer Fluid

### Switches

The windshield wiper switch (A) located on the right side of the cab headliner operates the windshield wiper (E). The wiper will continue to operate until the switch is returned to the OFF position. Replace the 39 inch wiper blade as necessary.

To activate the washer fluid pump, press the washer fluid switch (B) and hold until the desired amount of fluid is dispensed and then release the switch. You must turn the wiper OFF when the fluid has been completely wiped away. The washer fluid reservoir is located behind the cab (C).

The fluid spray nozzle (D) is adjustable. The fluid spray pattern should be checked at the beginning of each season and adjusted as necessary.

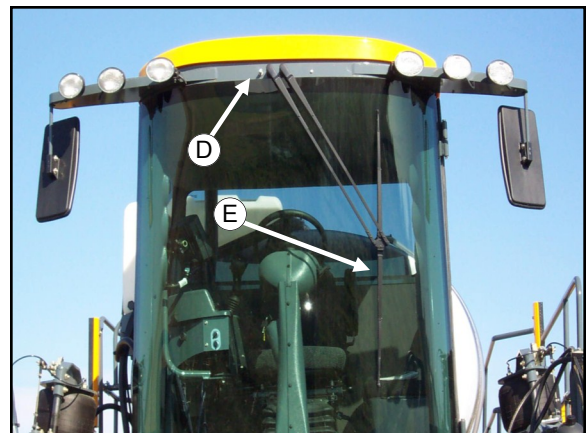
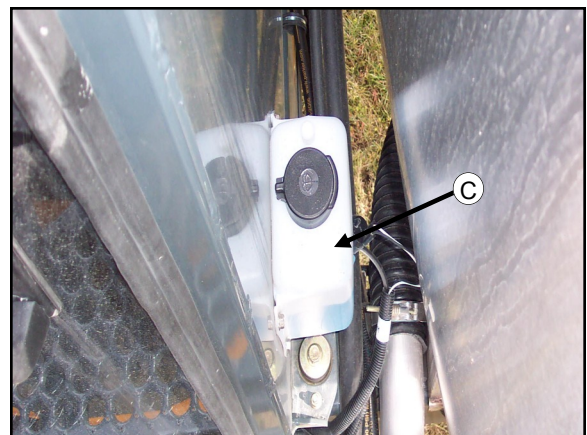
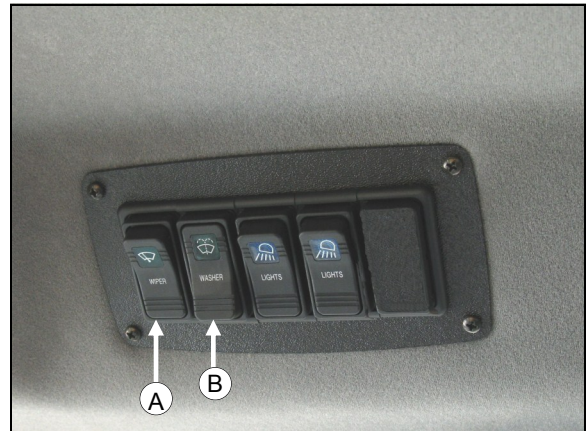

# OPERATOR'S STATION

## Field Lights and Work Lights

The field lights (C), located on the front of the cab with the headlights, are activated by pushing the switch located on the upper right cab headliner (A).

Use these lights when operating in the field after dark. Turn them off before entering a public roadway.

The work lights (D), located on each boom cradle, one facing forward and one facing rearward, are activated by pressing the other switch (B) located on the upper right cab headliner. These lights can also be used when operating in the field after dark. Turn them off before entering a public roadway.

The ignition key has to be on to operate these sets of lights, but extended use without the engine operating to charge the battery is not recommended.

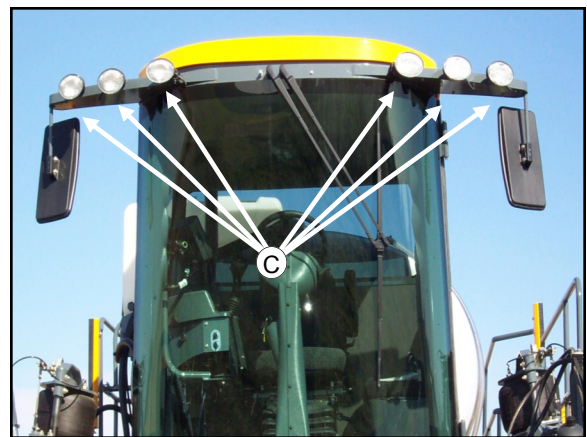
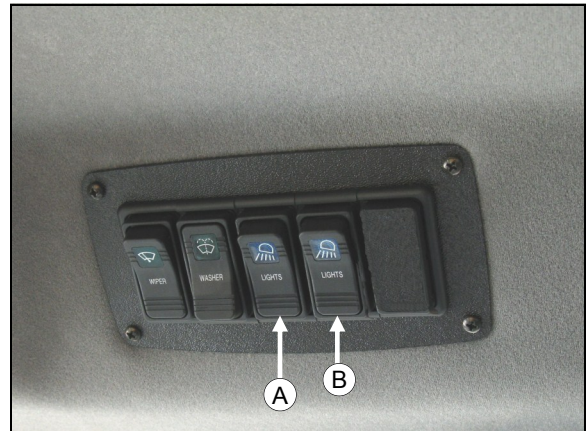

# OPERATOR'S STATION

## Raven Spray Control Console

The spray system is controlled by the Raven SCS 4600 (A) and the Pulse Width Modulated Control Valve (B). The system receives data and automatically makes adjustments based on the target rate of application set by the operator.

For detailed information regarding the programming and operating of the Raven console system, please refer to the manufacturer's installation and operation manual.

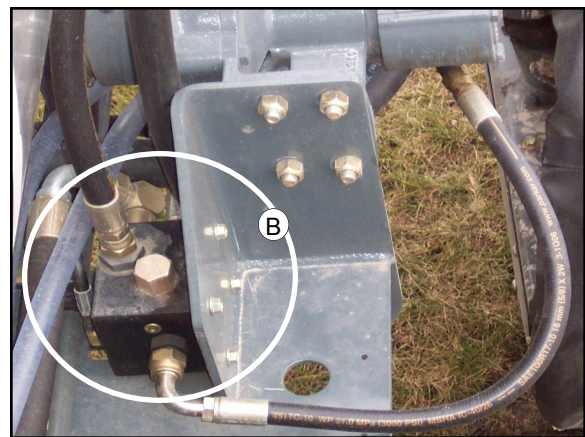

# OPERATOR'S STATION

## Other Features and Controls

- A. Emergency exit tool (Res-Q-Me tool)
- B. Cab glass
- C. Rear-viewing mirrors
- D. Air ride seat
- E. Buddy seat
- F. Fresh air filters

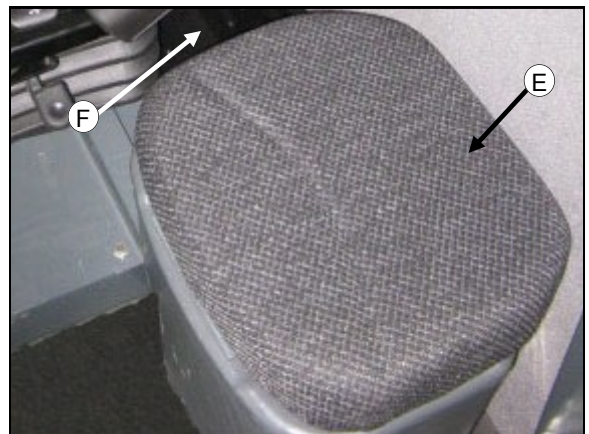
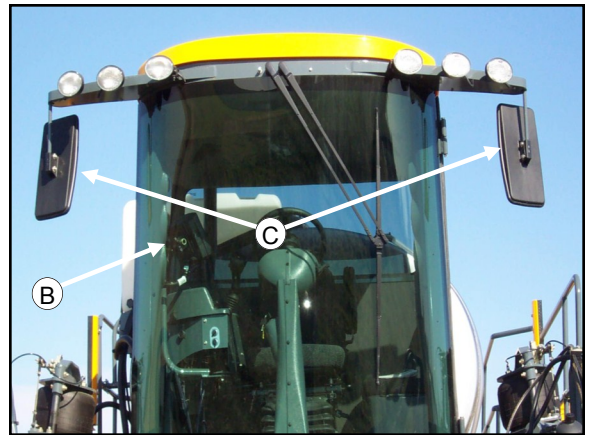
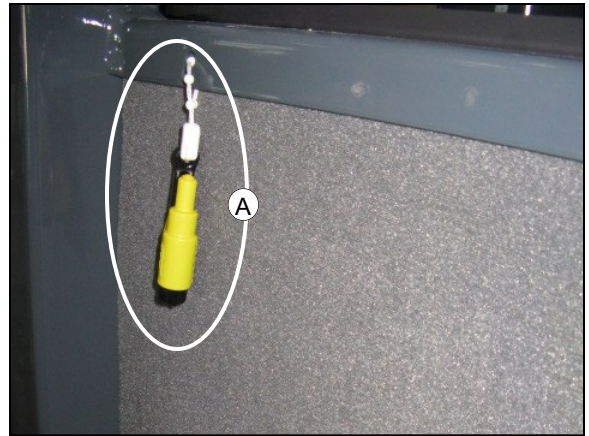

# OPERATOR'S STATION

## Emergency Exit (Res-Q-Me Tool)

The Res-Q-Me tool is located on the right rear cab frame. The tool is used to shatter the glass of the cab in the event of an emergency and the cab door is unable to be opened.

The tool, when firmly pressed against any glass in the cab, will automatically trigger, shattering the glass. Do not look directly at the glass when you use the tool.

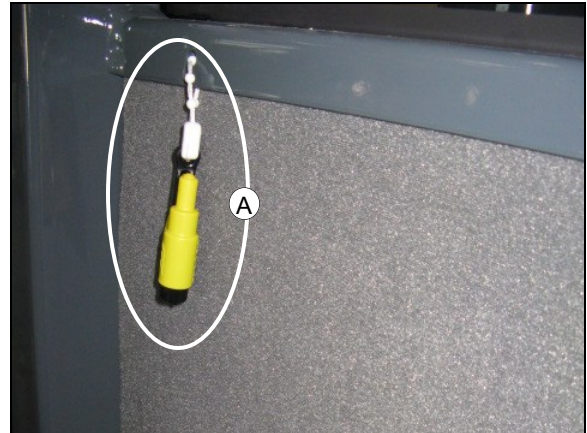

## Cab Glass

The glass of the cab (A) is DOT approved tempered glass. The front windshield is rounded with a green UV reflective tint and the side and rear glass panels are flat with a UV reflective gray tint.

The design of the cab and the use of the glass allows a 210° view, tip to tip of the booms from the operator's seat.

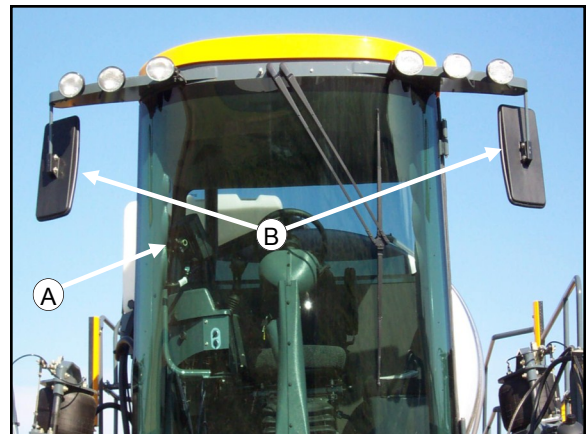

## Rear Viewing Mirrors

The cab is equipped with two external rear viewing mirrors (B).

## Fresh Air Filters

Inside the cab are two filters, a charcoal filter and a paper filter. Refer to the Service section on the filters for maintenance information. Refer to the Hagie Parts Manual for replacement part information.



# OPERATOR'S STATION

## Buddy Seat

The buddy seat (1) was designed as an instructional tool. It is specifically designed for a “co-pilot” to be seated in a good position to be taught how to use the sprayer.

The buddy seat has a hinged seat that lifts to reveal a storage compartment. Do not use the compartment to store chemical soaked clothing or gloves.



## Air Ride Seat

- A. **Height and Weight Adjustment**– Push or pull the actuator lever (A-1) until the green marking is visible in the indicator (A-2).
- B. **Fore/Aft Isolator**– Adjust the lever to lock or unlock the seat's lateral movement. Position 1 is locked and Position 2 is unlocked. After an adjustment from Position 2, the seat must be pushed back until there is an audible click. Once the seat is locked, it should not be possible to move it to another position.

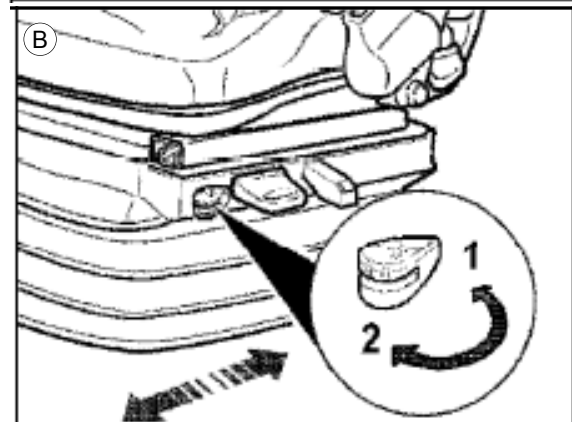
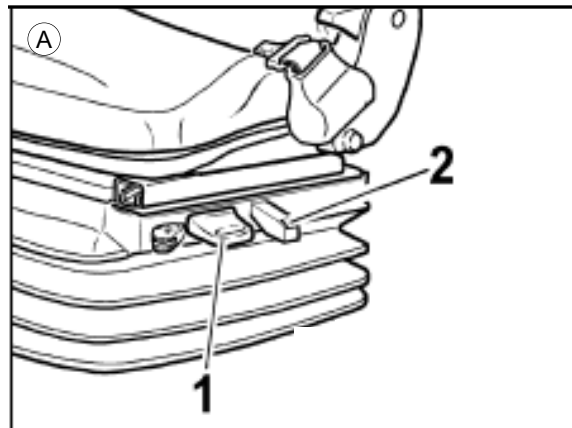

continued on next page



# OPERATOR'S STATION

- C. **Fore/Aft Adjustment-** Lift lever to allow adjustment.
- D. **Seat Pan Angle Adjustment-** Lift the left hand handle and exert pressure on or off the seat pan to adjust to the desired angle.
- E. **Seat Depth Adjustment-** Lift the right hand handle and move the seat cushion forwards or backwards to the desired position.
- F. **Lumbar Support Adjustment-** Turn the adjustment knob to adjust both the height and curvature of the backrest cushion.

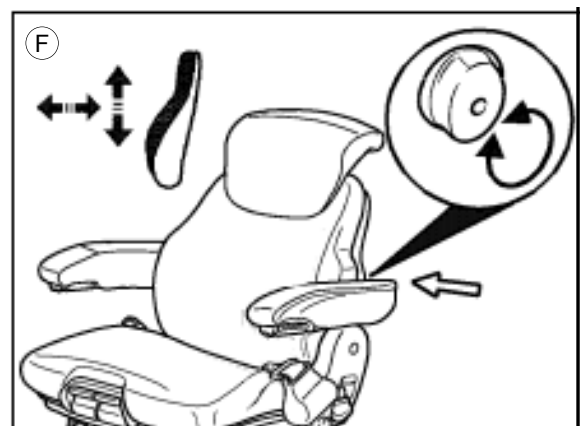
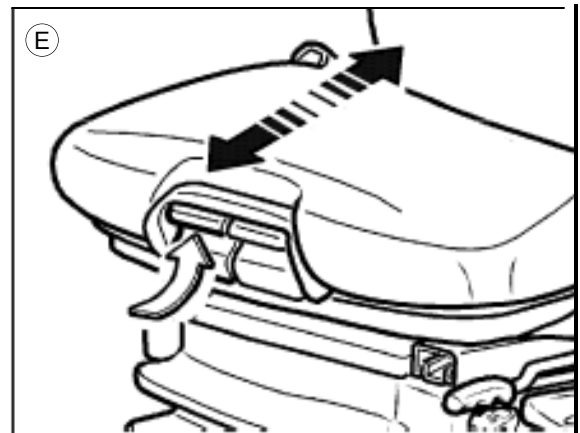
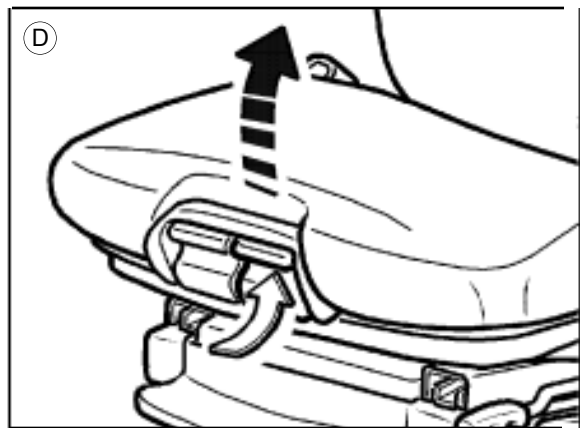
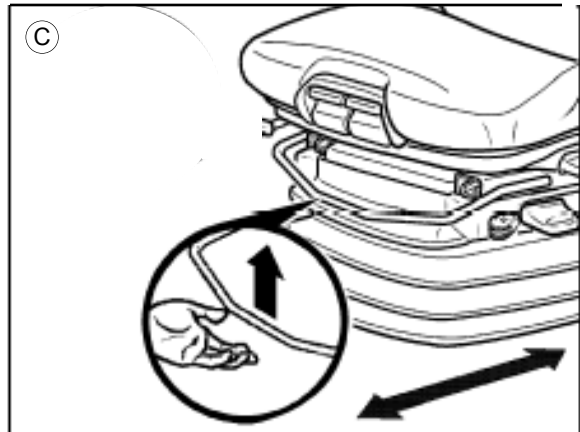

continued on next page

# OPERATOR'S STATION

- G. **Armrest Tilt Adjustment**– Turn the adjustment knob to the outside to raise the front of the armrest and to the inside to lower the front of the armrest.
- H. **Backrest Adjustment**– Lift the lever to release the lever. Apply or release pressure to allow the backrest to move to the desired position.
- I. **Absorber Adjustment**– Turn the lever to the desired position of shock absorbance. Position 1 is soft, position 2 is medium, and position 3 is hard.
- J. **Operator Presence Switch (OPS)** - Internally located, the electrical interlock ensures that attachment functions stop when the operator is not seated.

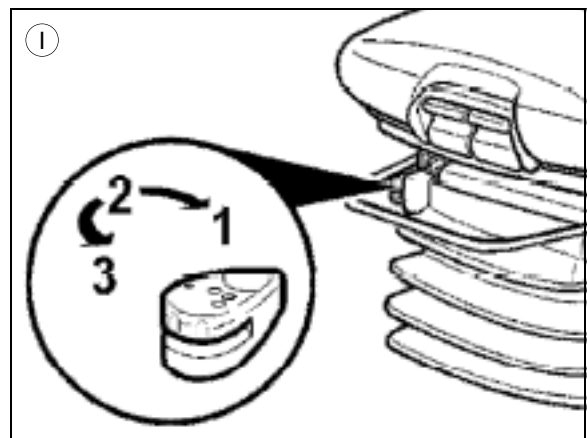
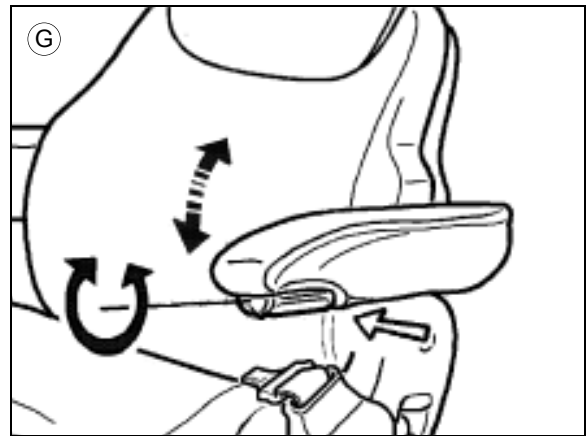

# OPERATOR'S STATION

## Air Ride Seat (Optional)

- A. Height and Weight Adjustment**-Push top of rocker switch to inflate and raise suspension. Push bottom of rocker switch to deflate and lower suspension
- B. Fore and aft slide adjustment**-slide to the left to unlock to allow for adjustment.
- C. Isolator Lockout**-Slide to the right to allow for adjustments
- D. Armrest Adjustment**-Rotate knob to adjust desired angle of armrest.
- E. Backrest adjustment knob (Recliner)**-rotate the knob forward or backward to adjust backrest angle
- F. Lumber/Bolster Adjustment system**-Use the two rocker switches to adjust the lumbar and bolster of the seat
- G. Seat Belt**-the seat belt has a retractor and buckle. It is highly recommended that you wear the seat belt at all times when operating the sprayer



# MD3 OPERATING INSTRUCTIONS

The MD3 is the control center of the machine. It helps to control approximately 90% of the machine's electronically driven products which in turn help to influence how the machine drives, how the All Wheel Steer operates, how the attachments operate, how the tread adjust operates, how the spray sections and the lights work, and how all of the diagnostics given to the operator work.

There are nine buttons that line the bottom and right hand side of the screen. For the purpose of customer service, the buttons have been assigned names, please be sure to use these names when speaking with a technician to help them understand what may be happening with the machine.

Button names:

- A. **F1**– far left side of the screen
- B. **F2**– second button from the left
- C. **F3**– third button from the left
- D. **F4**– fourth button from the left
- E. **Cancel/Home**– the fifth button from the left. The button has a left pointing arrow symbol on it.
- F. **Menu**– the far right corner. The button has three lines across its face.
- G. **Up Arrow**– top button on the right side. Has an upward pointing arrow on its face.
- H. **OK**– the second button down on the right side.
- I. **Down Arrow**– the third button down on the right side. The button has a downward pointing arrow on its face.



# MD3 OPERATING INSTRUCTIONS

The MD3 currently has three display pages, Home page (A) and Machine Hours page (B), and the Misc. Page (C). This is how these pages will be referred to throughout the rest of these instructions. The Home page should come up every time the machine is started.

The Up and Down Arrow buttons are the toggle buttons that will navigate through the pages. Push the Up Arrow button to go to the next page and the Down Arrow button to go to the previous page. Continuing to press the button will get you back to the page that you started from.



## NOTICE

Remember that all procedures start from the Home Page.

# MD3 OPERATING INSTRUCTIONS

## Toggleing Between Menu Screens

To navigate from the Home Page to the Main Menu (A), press the Menu button (B) in the lower right hand corner of the display face.

Use the Cancel/Home button (C) to go back one page at a time while in the Adjust, Measure, Preferences, and Info menus.

Use the "F" buttons (D) to select the group or menu from the Main Menu page. Also use them while in the menu for prompted requests.

Use the Cancel/Home button to go back to the Home Page from the Main Menu.



## Adjusting the Display Lighting

To adjust the lighting of the display:

1. Press the Menu button (B). The Main Menu will appear.
2. Press the F3 button (C) under "Preferences"
3. Press the F1 button under "Display"
4. Press the F2 button under "Backlight" to change the lighting or press the F3 button under "Screen Saver" to adjust the time that the screen is lit to its full intensity.
5. Toggle with the Up and Down arrow buttons (D) to desired level and then press the OK button (E) to accept the change.



# MD3 OPERATING INSTRUCTIONS

## Software Version

To view the software version in the MD3, press the Menu button (A) in the lower right hand corner of the display face. Enter the Info menu by pressing the F4 button (B) and the software version should be displayed at the top of the screen.



## Changing the Tire Size Value

It may be necessary to change the tire size value. Remember that for an accurate spray job, the speed of the machine must be accurate. If the tires are replaced with a different sized tire, this value must be changed.

1. Press the Menu button.
2. Press the F1 (A) button (Adjust).
3. Select "Operator Adjustments".
4. Toggle down to "Tire Size Selector" (B) using the DOWN arrow (C)
5. Press the OK button (D).
6. Toggle to the desired tire size.
7. Press the OK button.

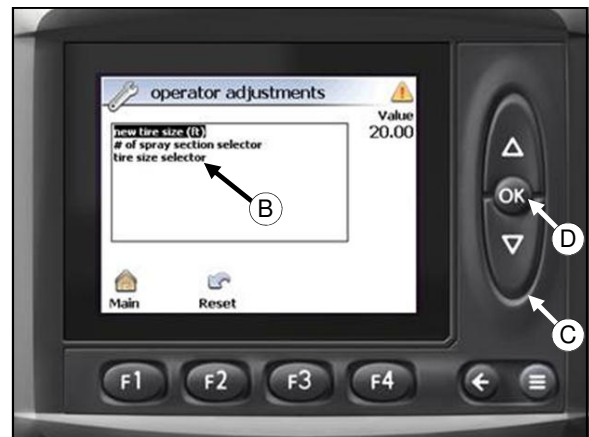

# MD3 OPERATING INSTRUCTIONS

## Changing the Unit of Measure

To change the unit of measure:

1. Press the Menu button (A) to get to the Main Menu.
2. Press the F1 button (B) under Adjust.
3. Use the Up and Down arrows (C) to toggle to display adjustments and select OK (D)
4. Toggle to UNITS ADJ parameter and select OK.
5. Toggle to a value of 1 for Standard Units or to a value of 2 for Metric Units and press OK.





# MD3 OPERATING INSTRUCTIONS

## Home Page

The Home Page has many features and functions. On this page is the analog tachometer, temperature gauge, fuel gauge, digital gear reading, digital speed reading, time, different warnings, and different operating system statuses. Continue reading this section for more information. Do not hesitate to call Hagie Manufacturing Company with any questions.



## Clock

The clock is located in the upper left corner of the display screen (A).

The clock is set to standard time. If this time zone is not correct, the time can be changed.

To change the date or time:

1. Press the Menu button (B).
2. Press the F3 button (Preferences)
3. Press the F2 button (Date/Time)
4. Press the F1 button for adjusting the Date or F2 for adjusting the Time.
5. Use the Up Arrow or Down Arrow to adjust the Date or Time to the desired value and then press the OK button to accept the changes.



# MD3 OPERATING INSTRUCTIONS

## Warning Light Indicator

There is a red light that will illuminate to the right of the clock (A) when there is an error that needs attention. The light will be accompanied with a message (B) telling what the error is and what should be done to correct it. The message can be cleared by pressing the F2 button below OK, but the light will remain illuminated until the error has been corrected.



## Refer to Operator's Manual

A blue manual icon (A) will appear to the right of the page title when an error has occurred (such as a service interval has been reached) that requires the operator to refer to the manual for more information. A warning will accompany the icon also stating that the operator need to refer to the manual for more information.



## Main Spray Indicator

A green indicator light (A) will illuminate directly above the tachometer indicating that the main solution control switch on the hydrostatic lever has been activated. Read more about this indicator in the Spray Systems section of this manual.



# MD3 OPERATING INSTRUCTIONS

## Tachometer

There is an analog and digital tachometer display in the left middle of the Home Page.

The tachometer displays the engine's revolutions per minute (RPMs).



## Temperature Gauge

The temperature gauge (A) is an analog gauge located next to the tachometer in the center of the display page.

The gauge indicates the temperature of the engine. If the engine temperature gets to an intolerant level, a warning light directly above the gauge will illuminate (B).

If the temperature rises still after the initial warning, a second warning (C) will appear shortly before the machine begins to go into a protective mode. If this warning appears, immediately reduce the engine speed to help prevent engine damage. Shut the machine down as soon as possible and troubleshoot the issue. Contact Hagie Customer Service if you are unable to resolve the issue.

When this warning appears, the machine may be severely limited in engine and hydraulic functions to prevent damage to those systems. The warning will disappear and the buzzer will go off by pressing F2 to clear, but it does not correct the problem. The red warning light at the top (D) will continue to flash until the fault is resolved.



# MD3 OPERATING INSTRUCTIONS

## Fuel Gauge

The fuel gauge is a bar gauge indicating the amount of fuel in the tank. Below the bar reading is a digital reading that indicates the number of gallons (liters) in the tank.

When the fuel level in the tank reaches a minimum level, a warning light will appear directly above the gauge. The light will not disappear until the fuel level is above the minimum level.



## Gear Display

The gear (speed range) that the machine is traveling in is digitally displayed in the far right hand center section of the display screen.

The gears are the same in both road and field state with road state having an extra gear that is not achievable while in field state.



## Speedometer

The speed in which the machine is traveling is digitally displayed directly below the gear reading on the right hand side of the Home Page.

The unit of measure can be changed from miles per hour (MPH) to kilometers per hour (K/h). The unit of measure is displayed to the right of the word "SPEED".



# MD3 OPERATING INSTRUCTIONS

## Drive State (F1)

The drive state of the machine is displayed at the bottom far left corner of the screen. The drive state is a safety measure that can not be changed unless the machine is in neutral. The machine has three drive states, road, field and fault. The drive state helps the machine determine what kind of work it is meant to do, field work or transport work.

In road state, the machine is limited on what functions can be operated, for instance, the spray booms are not able to be operated. Road state is used for the transporting of the machine and therefore will allow the machine to reach maximum speed.

Field state allows the functions of the attachments, such as the spray boom, to operate. All wheel steer (if equipped) is also only allowed while in field state. The machine is also limited on speed and is unable to reach maximum speed while in the field.

The third drive state, "drive fault" (B), may show if there is a system error that effects the machine's ability to function. This is called a drive fault and the MD3 should show a message explaining why it happened and what if anything should be done. Severe warnings will be accompanied by a shut down or power down of systems to protect the machine (C). This drive state is automatic and can not be voluntarily selected.

To toggle between the two drive states, make sure there are no drive faults present and that the machine is in neutral. Press the F1 button until the desired drive state appears below "Drive State" on the display screen.



# MD3 OPERATING INSTRUCTIONS

## F2 Function Button

The F2 function button is not directly associated with anything on the Home Page. The warnings that appear on the screen (drive faults, service warnings, system errors, etc.) will be able to be acknowledged through pushing the F2 button.



## All Wheel Steer (F3) ▲

The F3 function button is associated with the AWS. The AWS will appear on the screen even if it is not installed on the machine (A) and pressing the button will not change the machine's functions.

All conditions must be met before AWS will engage. First the machine must be in "field" drive state, and second, the machine must be in gear 1. If these conditions are not met, the AWS will remain on, but will still be in conventional steering.

The F3 function button will only toggle the AWS from ON to OFF, the machine will automatically determine if the proper conditions are met and change the status of the drive functions. These changes will be reflected on the MD3. When AWS is activated and engaged, the display will read "coord" shortened for "coordinated steering" (B). If the AWS is on, but not engaged, the display will read "normal" meaning that you are in conventional steering, but the AWS will engage automatically when the proper conditions are met. When the AWS is not on, the display will read "OFF".



▲ Operators with machines equipped with All Wheel Steer pay special attention!

# MD3 OPERATING INSTRUCTIONS

## Float (F4)

The float button (A) will only appear if an attachment requiring float functions is connected to the machine. Such attachments would include the Nitrogen Tool Bar. If there isn't an attachment connected that requires float, there will be dashes that appear on the display.

The functions of float are not discussed any further in this manual, but are included in the manuals for the attachments that require its use.



# MD3 OPERATING INSTRUCTIONS

## Machine Hours

The second page of the MD3 is titled “Machine Hours” and can be found by using the Down Arrow (A) key to toggle to the next page from the Home Page.

This page is a service tool for operators to use to set and track service intervals. There are several things that need to be serviced at specific intervals and you will see these intervals on this page (50 hrs, 100 hrs, 500 hrs, etc.). Please refer to the service section of this manual for details regarding on what parts of the machine need serviced and the procedure to perform the service at each interval.

Some of the service intervals can be adjusted to suit your schedule if you do not want to wait as long as possible to perform some of the services, such as oil and filter servicing. The default on the Machine Hours page is the recommended practices of the engine manufacturer, however, these practices are also discussed as being fairly loosely interpreted based on how the machine is used and they can be done on shorter intervals than what is recommended. The default will not be able to be extended past the recommendation.

When a service interval is reached, a “manual” icon (B) will appear at the top of the Home Page and a message telling you that a service interval has been reached (C). The message will disappear by pressing F2, but the icon will remain at the top of the page until the hours of the interval have been reset.





# MD3 OPERATING INSTRUCTIONS

## Adjusting Service Intervals

The Machine Hours page has three columns of information. The first column tells you what service action or interval the hours are referring to. The second column tells the hours since the last service. The third column tells how many hours before the next service.

The engine oil/filter, hydraulic filter, and hydraulic oil intervals can be adjusted to suit your needs. The remaining intervals can not be adjusted.

To adjust the service intervals:

1. Press the Menu button (A) in the lower right hand corner of the display face.
2. Press the F1 button under adjust.
3. Use the Down Arrow to toggle down to the Service Interval Group (B). Press OK to select.
4. Adjust the interval and press OK to accept the changes.



## Resetting Service Hours

Once a service procedure has been completed, the hours must be reset. To reset the service hours:

1. Press the Menu button in the lower right hand corner of the display face.
2. Press the F1 button to adjust.
3. Use the Down Arrow to select the Service Reset group.
4. Reset the parameters, by toggling the parameters to 1 and then back to 0 using the UP and Down Arrow keys.



# MD3 OPERATING INSTRUCTIONS

## Miscellaneous Page

The third page is an information only entitled Misc Page. This page gives you current tire size, current tread adjust setting, and the tread setting on both the left and right side separately. You can not adjust anything from this page.



## 120 Boom Sensor Page

The 120 Boom Sensor Page is present in all machines, but will not function in machines without the 120 boom attachment. If your machine is equipped with the 120 boom, please refer to the attachment's manual for instruction on the use of this page.



# HYDROSTATIC SYSTEM

## Hydrostatic Drive Components

- A. Cummins engine
- B. Tandem hydrostatic pumps
- C. Front and rear wheel motors
- D. Wheel hubs

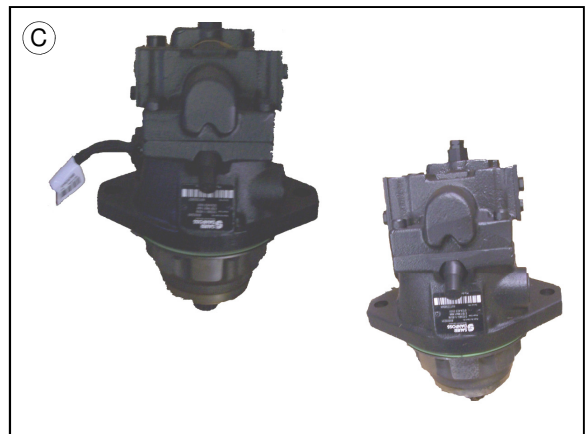
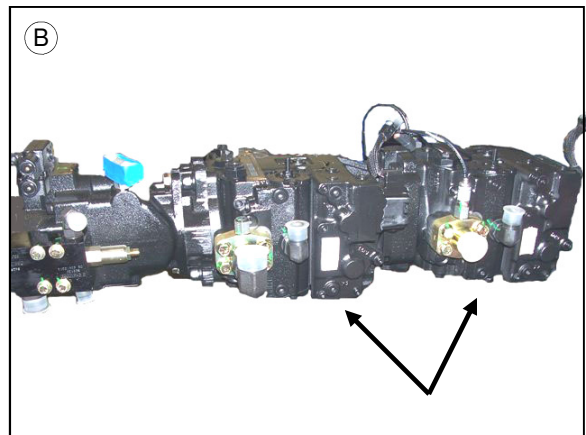
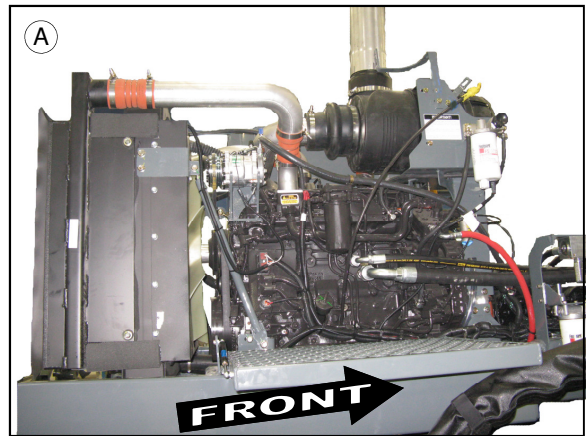

# HYDROSTATIC SYSTEM

## Cummins Engine

The STS comes standard with a 275hp Cummins diesel engine (A) equipped with an automatic exhaust brake. The engine has a direct-mounted Sauer-Danfoss 90 Series tandem hydrostatic pump (B). More information on the operation of the engine is contained in this section.

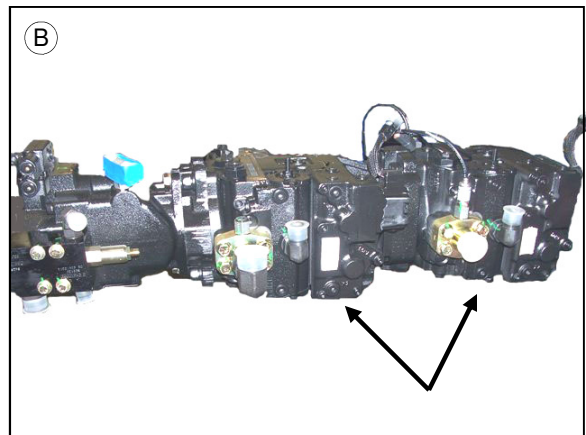
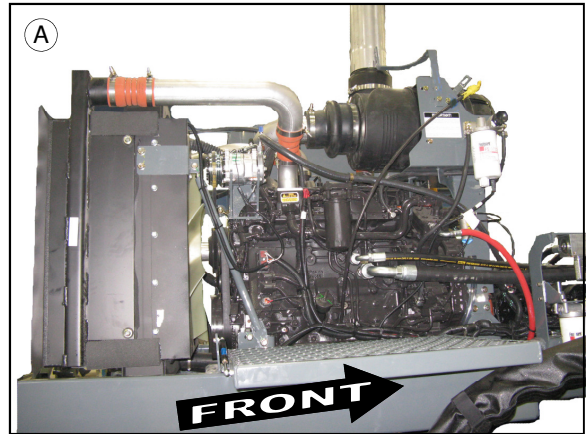

## Wheel Motors and Wheel Hubs

The all-time four wheel drive system consists of Sauer– Danfoss hydrostatic wheel motors (A) and the planetary gear reduction hubs (wheel hubs)(B).



# HYDROSTATIC SYSTEM



**Caution:** Start the engine from the operator's seat only. When running the engine in a building, be sure that there is adequate ventilation.

## Pre-operational Checks

1. Check the engine oil level. Do not operate when oil is below the low mark on the dipstick.
2. Check the coolant level in the radiator and the coolant overflow reservoir.
3. Check the hydraulic oil reservoir level.
4. Check the cooling air intake screen.
5. Check the Filter Minder®
6. Drain fuel/ water separator.
7. Check the engine drive belt.
8. Drain any water out of the air tank daily.
9. Check for any oil or fuel leaks and correct them if needed.

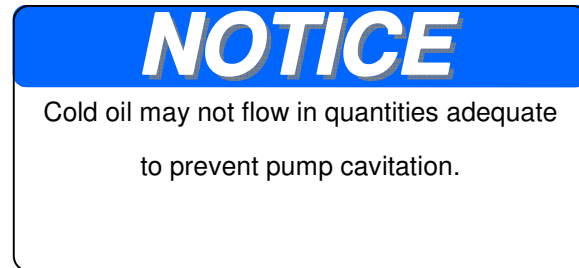

# HYDROSTATIC SYSTEM

## Starting the Engine

1. Position the hydrostatic lever to the neutral position.
2. Put the parking brake switch to the ON position . (See the information contained in this section on the parking brake)
3. Turn the ignition ON, but do not engage the starter. Wait for the “wait to start” warning light and message to disappear. Make sure that there aren’t any other warnings before continuing.
4. Engage the starter. If the engine fails to start after 15 seconds, turn the key to OFF, wait one minute and repeat the procedure. If the engine does not start in three attempts, check the fuel supply system. Absence of blue or white exhaust smoke during cranking indicates that no fuel is being delivered.
5. Observe the warning lights on the MD3 after start up. If any functions do not operate, shut off engine and determine the cause.
6. Always allow at least a five minute warm-up period before operating the engine at high RPM. This means that the engine must reach operating temperature and oil pressure must stabilize in the normal operating range before it is run faster than idle (1000 RPM or less).

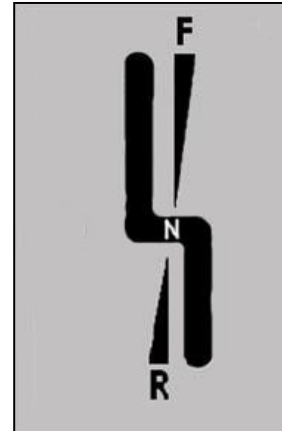

# HYDROSTATIC SYSTEM

## Battery Disconnect

The STS is set up with a battery disconnect safety device. The device is located on the left side of the rear frame cross tube. When the key is turned to the OFF position the electrical circuit is broken therefore rendering the machine unable to start. Do not use this device as a safety when working on the electrical system— disconnect the negative battery cable before servicing.

This device is also used as an anti-theft safeguard. Keep the key in a safe place, out of the machine when it is not in use.

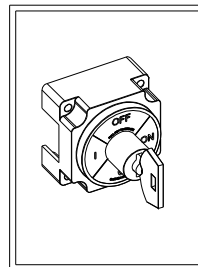

## IMPORTANT

Do not use disconnect to stop engine. Do not bypass disconnect. Do not terminate electrical devices to battery terminals. Disconnect negative before servicing electrical equipment. Completely isolate electronics before welding. Key must be inserted and rotated to "ON" position for operation.

## Parking Brake

The parking brake will engage if the charge pressure falls below 150 PSI or the engine is shut off. To engage the brakes manually, press the top of the Parking Brake/Ladder switch located on the side console.

To disengage the brakes, press the bottom of the switch. Always turn the brake off before moving the sprayer.

The brake switch must be engaged to lower the ladder and to run the side-fill or pressure washer. The ladder will automatically lower when the brake switch is pressed (see the section on the ladder for more information).

 **Caution:** Activating the brake while the machine is moving is potentially hazardous to the operator and the sprayer.

**NOTICE**

The parking brake will not engage at speeds over 1 mile per hour.

# HYDROSTATIC SYSTEM

## ACE: Automatically Controlled Engine

1. Speed ranges are selected by a red (decrease speed range) and green (increase speed range) electronic switch mounted on the hydrostatic lever. The lower the setting, the higher the torque, but the lower the speed.
2. To move forward, slowly push the hydrostatic lever forward. The farther the lever is moved, the faster the sprayer will travel and the engine speed (RPMs) will increase. To stop, slowly pull the lever to the neutral position.
3. To reverse the machine, slowly pull the lever back. To stop, slowly push the lever to the neutral position.
4. Before turning off the engine, reduce the engine speed and allow the engine to idle for at least three minutes.

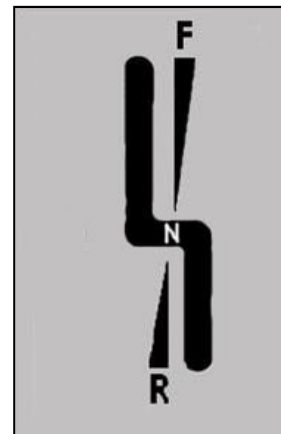

## NOTICE

The operator can choose the minimum level above 850 RPMs of engine speed that they want to operate the machine with by using the throttle switch. See the throttle switch section for more information.



# HYDROSTATIC SYSTEM

## Speed Control

Speed control may be adjusted with the speed control dial. This will conveniently help regain consistent field speeds when re-entering a field from the end rows.

To set a speed limit, start with the engine at 1800 RPM and speed control dial all the way counterclockwise. Push the hydrostatic lever all the way forward. Now turn the speed control clockwise while observing ground speed and stop turning the dial when the desired ground speed is reached. Now your maximum field speed is set and you simply reposition the lever all the way forward to regain that speed.



# HYDRAULIC SYSTEM

## Hydraulic System Components

- A. Hydraulic pump
- B. Gear pump
- C. Solution pump

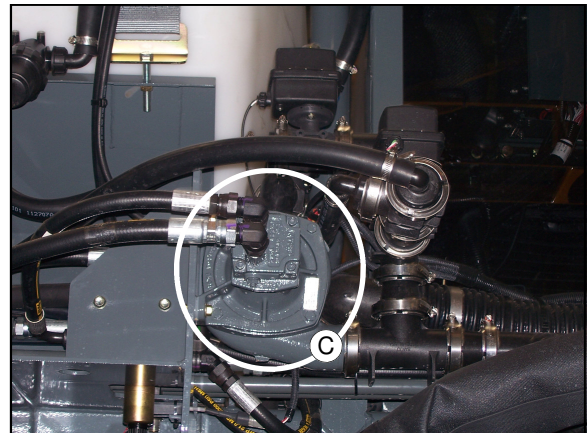
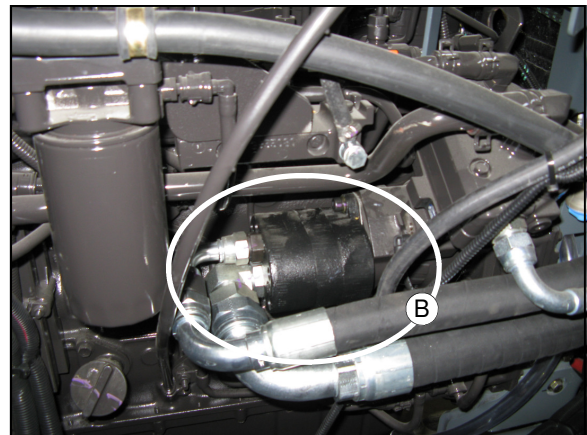
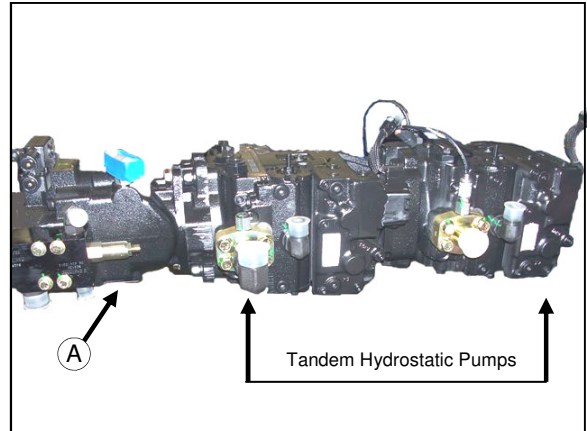

continued on next page

# HYDRAULIC SYSTEM

D. Power steering

E. Tread adjust

F. Spray booms

G. Ladder

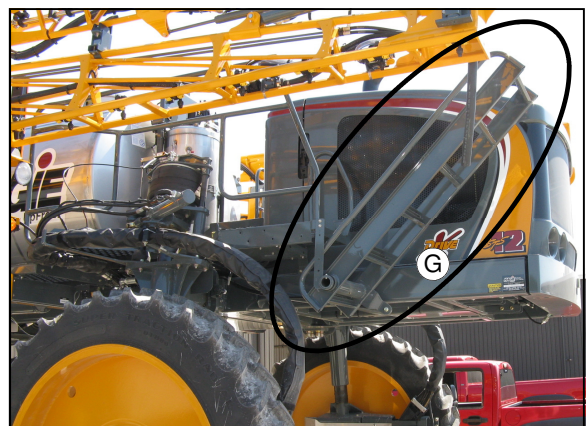
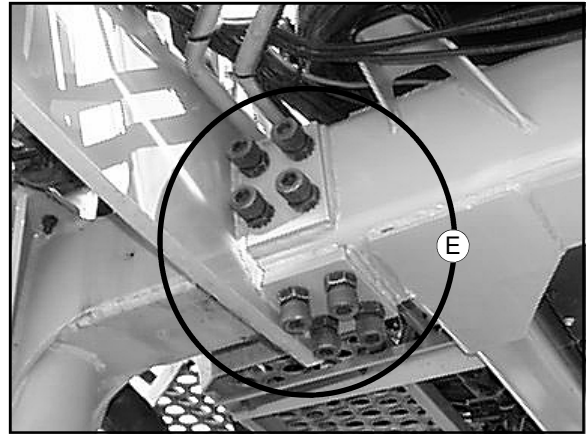
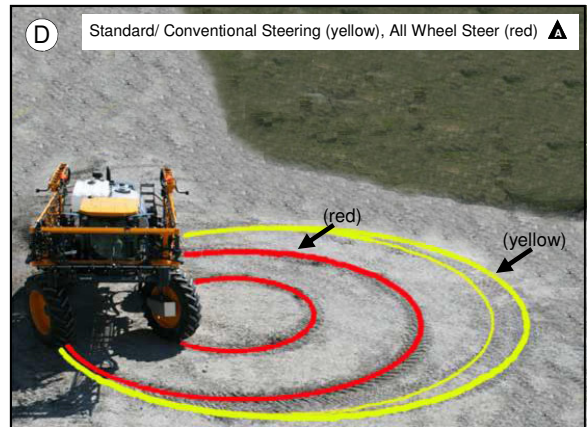

**▲** Operators with machines equipped with All Wheel Steer pay special attention!

# HYDRAULIC SYSTEM

## Auxiliary Hydraulic System (Hydraulic pump and Gear pump)

The auxiliary hydraulic system is a load sensing, pressure compensated system with efficiency in mind. That means it only pumps the amount of oil needed to do the job.

The pump is mounted to the “front” of the second hydrostatic pump (A). The system consists of a single variable displacement pump that supplies the required hydraulics to operate the full time power steering unit, boom control cylinders (lift, level, and fold), tread adjust, ladder, outer boom breakaway, and the solution pump.

The pump circulates the hydraulic oil throughout the necessary systems and back through a cooler before returning it to the reservoir. If the level in the reservoir drops too low to safely operate the machine you must shut down the engine immediately to prevent damage to the hydraulic system.

The return oil from the load sense pump is mixed with the oil from the gear pump (B) on the side of the engine. This pump supplies a constant flow of oil from the hydraulic tank to the cooler and then back to the tank through the filter. This is considered a kidney loop and is dedicated to the cooling and filtration of the hydraulic system.

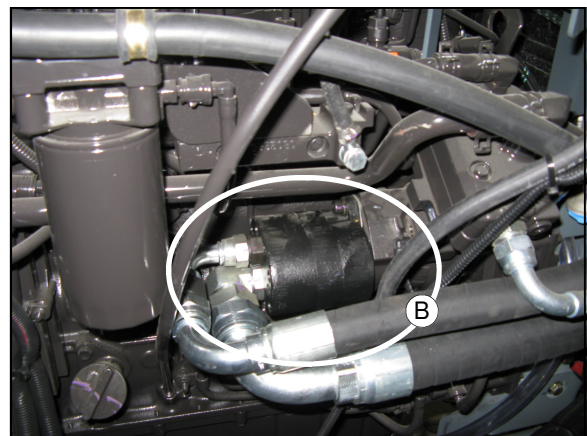
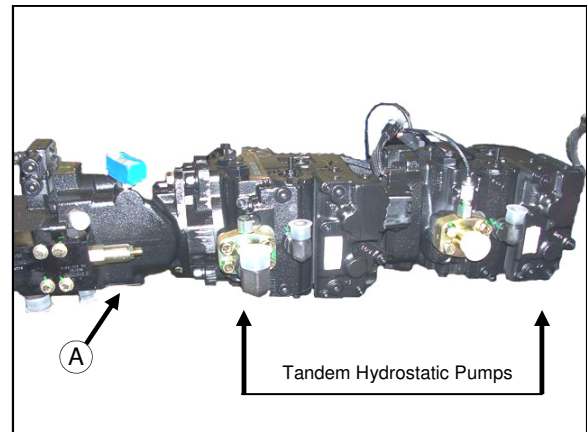

# HYDRAULIC SYSTEM

## Solution Pump

The solution pump is a centrifugal pump controlled hydraulically with the pulse width modulated control valve. The valve is controlled by the Raven console per the calibration settings entered by the operator.

The solution pump is also used to distribute the water or cleaning solution from the rinse tank through the rinse systems.

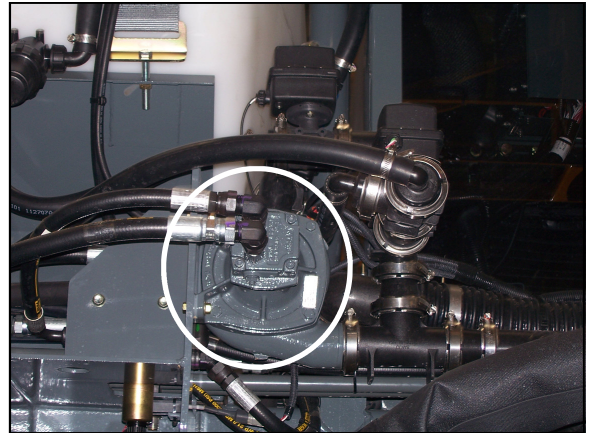

## Power Steering System

The power steering system is a dedicated circuit steering system with full time control, self centering/ double action steering cylinders. (See the section on All Wheel Steer for more information) ▲

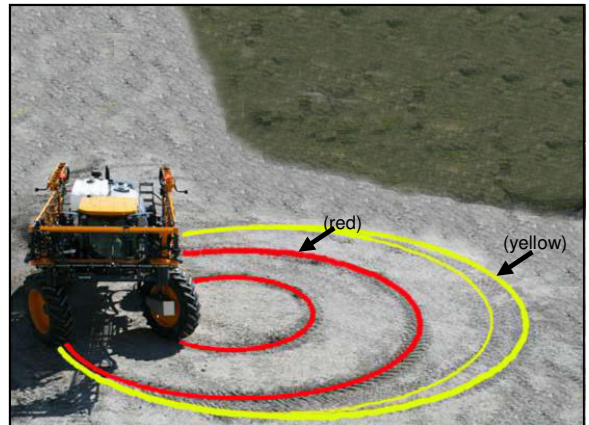

Standard/ Conventional Steering (yellow), All Wheel Steer (red) ▲

▲ Operators with machines equipped with All Wheel Steer pay special attention!

# HYDRAULIC SYSTEM

## Ladder

To raise or lower the ladder you will need to locate the BRAKE/LADDER switch at the front of the right hand console (A). When the brake is applied the ladder will lower automatically. The ladder will not raise until the machine is running and the switch has been returned to the OFF position.

**!** **Caution:** Upright ladder is not a service platform or step. DO NOT step on the ladder while in upright position. DO NOT lower the ladder while anyone is on the ground near the sprayer. DO NOT attempt to lower the ladder from the ground level.



# HYDRAULIC SYSTEM

## Hydraulic Tread Adjust

To adjust the tread width hydraulically follow the instructions below:

1. Survey the surroundings and allow yourself enough room to adjust the tread in either forward or reverse.
2. Locate the tread adjustment switches on the rear of the side console (A). They are marked LF (left front), LR (left rear), RF (right front), and RR (right rear). The legs may be moved in or out on each side independently\*. While driving between one and two miles per hour, press and hold the desired switches to move the tread in the desired direction. Pressing the top of any switch will move that leg OUT and pressing the bottom of any switch will move that leg IN.
3. Observe the tread width on each leg. The front legs use indicator decals (B) while the rear legs use electronic sensors and display the readings on the message center (C). Release the switches when the tread indicator reaches the desired tread width.
4. After tread adjustment is complete, all four tread width indicators should have identical readings.

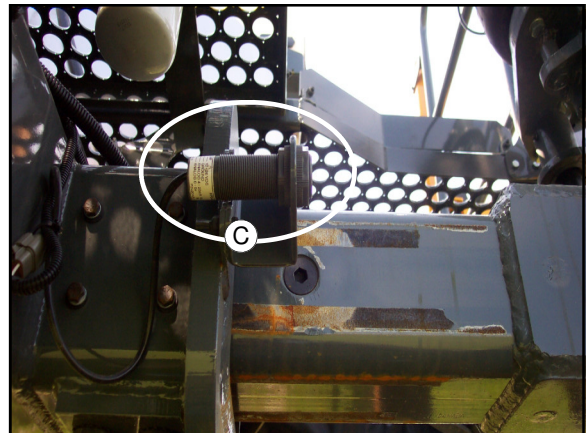
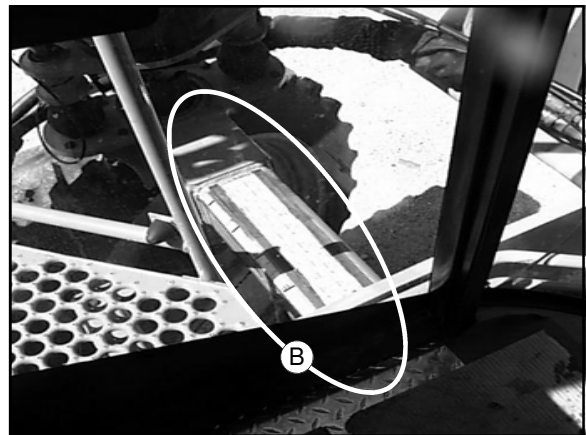

continued on next page

\*When a significant adjustment is being made, it is recommended that you adjust one leg at a time and do the adjustments in smaller increments. Binding may occur if a larger adjustment is made all at once, especially if adjusting one leg at a time.

# HYDRAULIC SYSTEM

5. To recalibrate (phasing the cylinders) toe-in:

1) While driving forward slowly, turn the steering wheel all the way one way until both steering cylinders bottom out; continue turning the wheel a little more to let fluid bypass the cylinder.

2) Then turn the wheel all the way the other way and repeat the process.

3) When the wheels are then straightened, the steering cylinders should be re-centered and correct toe-in should be obtained. To check the cylinders for center, measure the cylinder rod (B) (both cylinders should measure 7.64 in. at center). (see the service section regarding toe-in for more information)

 **Caution:** Never adjust the hydraulic tread width on a public roadway. Make sure the sprayer is on level ground where there are no ditches or valleys to interfere while you perform the adjustment.



## NOTICE

AWS machines do not need to do step three. The steering will be set to center after cylinder calibration which must be performed by Hagie Service personnel.



# HYDRAULIC SYSTEM

## Spray Booms

Hydraulically folding the extensions of the 60/80/90 foot boom system, adjusting the spray valves, and recalibrating the spray console essentially turns it into a 60 foot boom. (see the next page for diagrams and continue reading this section for more information) Manually folding the outer extensions of the 60/80/90 foot boom, adjusting the spray valves, and recalibrating the spray console turns it into an 80 foot boom. Refer to the section on the spray console for information on calibration.

The spray booms are controlled by an electro-hydraulic system. This system consists of operator manipulated switches located in the sprayer's cab and hydraulic cylinders attached to the booms. It provides lift, level, horizontal extension, and vertical extension.

All STS spray booms are equipped with a hydraulic breakaway circuit (A). When folded out as an 80 or 90 foot spray boom, a one-way hydraulic circuit on the outer boom section provides outer boom breakaway functions. The outer breakaway is self-resetting and will return to normal operating position after it has cleared the hazard.



continued on next page

# HYDRAULIC SYSTEM

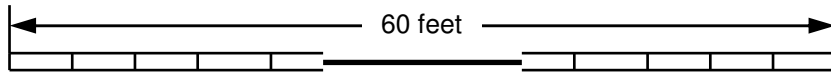

60/80/90 foot system with extensions folded over.

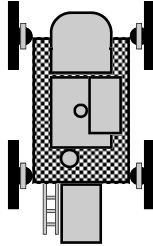

For instruction on hydraulically folding extensions over, see page 40-13.

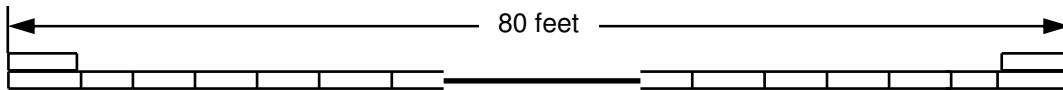

60/80/90 foot boom system with outer extensions manually folded forward.

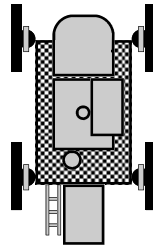

For information on manually folding outer extensions forward, see page 40-14.

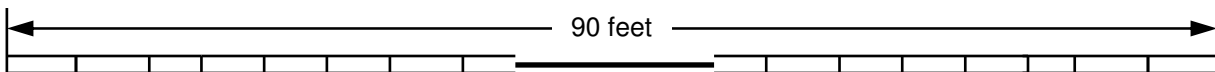

60/80/90 foot boom system with all extensions folded out.

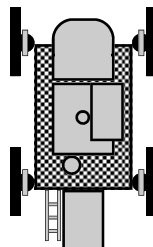

# HYDRAULIC SYSTEM

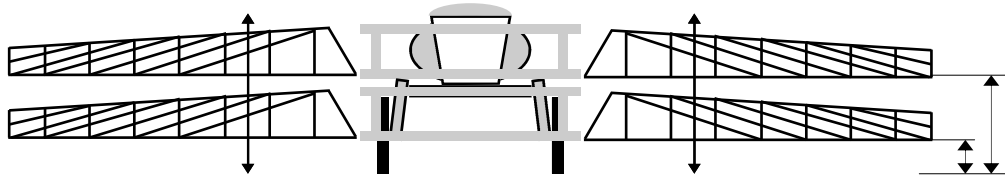

## Lift

To raise and lower the transom/ boom assembly, depress the “square rocker” on the hydrostatic lever (A) and move it either UP or DOWN. While pressed, it will activate the transom lift cylinders (B).

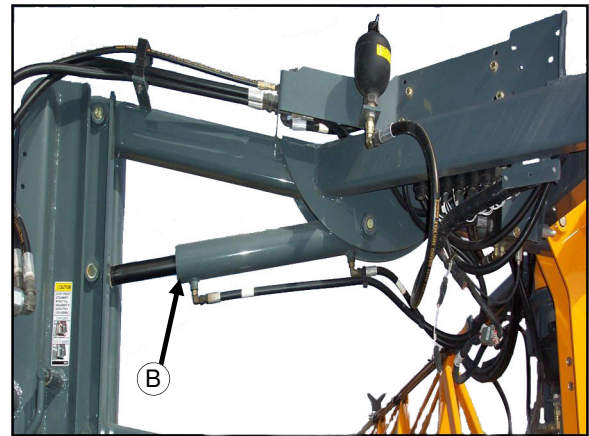

## NOTICE

See your spray tip manufacturer's guide for information regarding spray tip height.

# HYDRAULIC SYSTEM

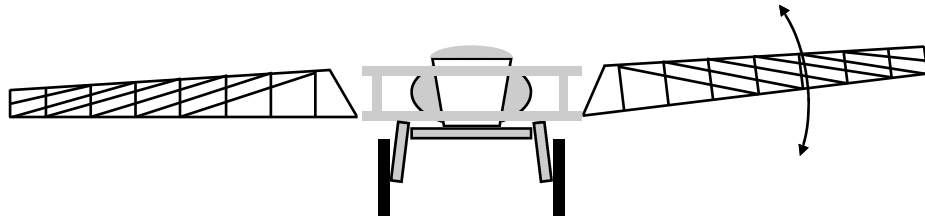

## Level

To increase or decrease the angle of the individual boom levels, depress the right or left “round rocker” UP or DOWN on the hydrostatic lever (A). While depressed, these buttons activate the level cylinders connecting either boom to the transom (B).

This adjustment also aids in placing the booms correctly in the cradles for transporting and storage.

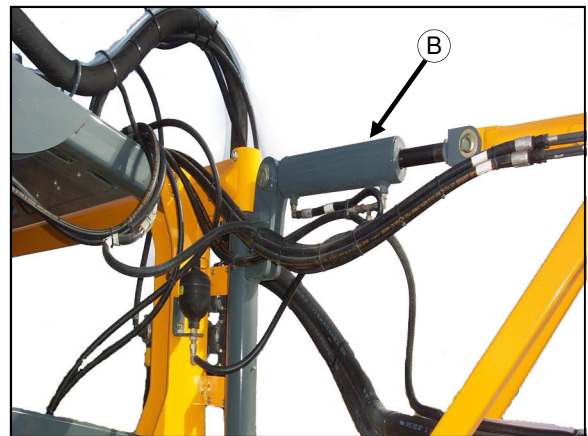

# HYDRAULIC SYSTEM

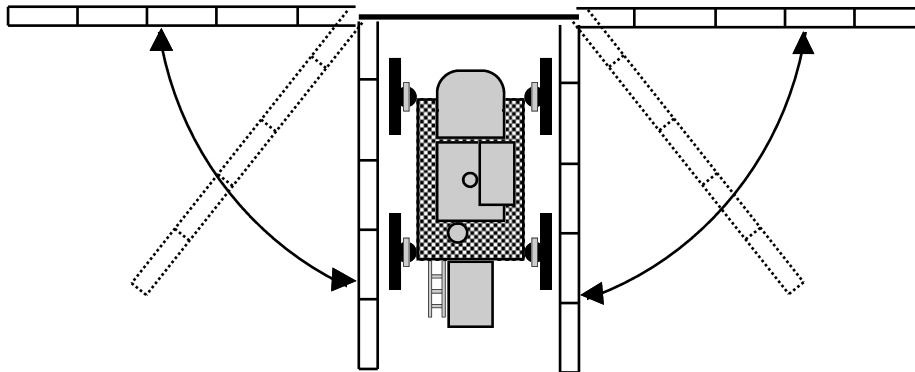

## Horizontal Boom Extension

To fold either boom horizontally in toward the machine or out, depress the right or left “round rocker” IN or OUT switches on the hydrostatic lever (A). While depressed, these switches activate cylinders connecting either boom to the transom (B).

Fold or unfold the booms in an open area only. Make sure no one is standing in the boom fold’s travel path. Booms can be folded if the machine speed is less than 5 MPH.

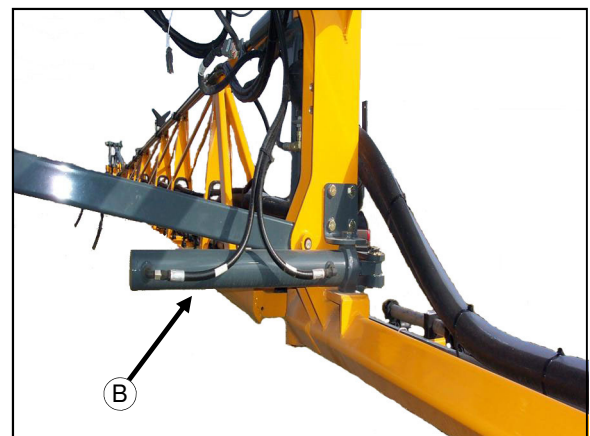

# HYDRAULIC SYSTEM

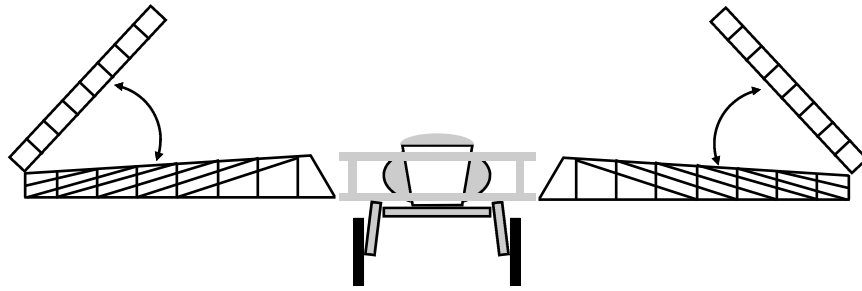

## Vertical Extension

To fold the boom extensions vertically in or out, depress the top or bottom of the BOOM EXTENSION switch (A) on the side console. This activates **BOTH** extension cylinders connecting the inner boom section and the center boom section (B).

Fold or unfold the booms in an open area only. Make sure that there are no overhead obstructions or power lines to interfere with extension folding.

**The booms will vertically unfold even if they are still in the boom cradle or are not horizontally extended!**

 **Caution:** Boom extensions can only be folded when the hydrostatic lever is in the neutral position and you have pushed the **ACK** (acknowledge) on the MD3 showing that you have acknowledge that there are no power lines overhead. If the sprayer is put in gear during folding, the boom movement will stop.



# HYDRAULIC SYSTEM

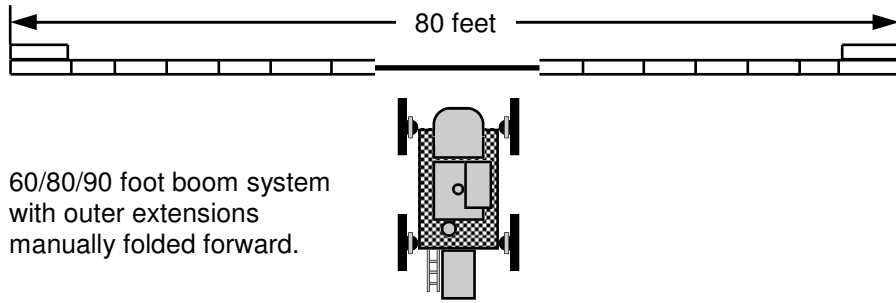

## Manually Folding from 90' to 80'

To convert a 90 foot boom to an 80 foot boom, manually close the solution valve on the outer section (A). Remove the pin on the back side of the boom (B) so it will hinge forward (C) and secure it with the rear pin (D). Repeat these steps on the other side and recalibrate the console accordingly (see the Raven manufacturer's guide) before spraying resumes.

Continue reading the manual for information on adjusting the foam marker.

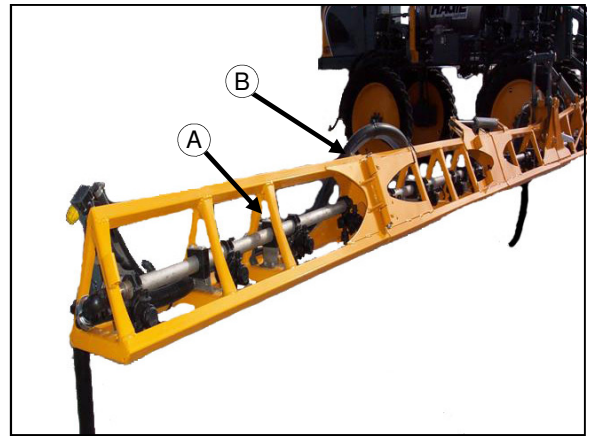

# SPRAY SYSTEM



## Introduction

The spraying system is a constantly monitored and continuously adjusted computer controlled system. The cab mounted digital console receives information from various inputs to help determine GPM (gallons per minute) and GPA (gallons per acre).

This section explains the components of the spray system. Please read the entire section before operating the spray system. This section is not designed to replace the Raven manual and the numbers used may not reflect your specific situation. Read all manuals before operating the equipment.

## Getting Started:

1. Calibrate the spray system console.
2. Check the quantity of solution in the tank.
3. Start the engine.
4. Open the tank valves, if desired, activate the agitation system.
5. Press the F1 switch on the MD3 until the machine's drive state reads "field".
6. Turn on the main spray power.
7. Place the individual boom solution valve switches to the ON position.
8. Slowly move the hydrostatic lever forward to obtain the desired ground speed.
9. Frequently observe the pressure gauge.  
When it drops to zero, or spray pattern deteriorates, shut off the main spray power, solution pump, and agitation system until refilling solution.

## NOTICE

Never attempt to operate the spray system without solution in the spray tank. Operating the spray system with no solution in the tank will cause severe damage and void the warranty.





# SPRAY SYSTEM

## Spray System Components

- A. 1400g Stainless steel tank
- B. Solution pump
- C. Flow meter
- D. Pressure gauge
- E. Individual solution control valves

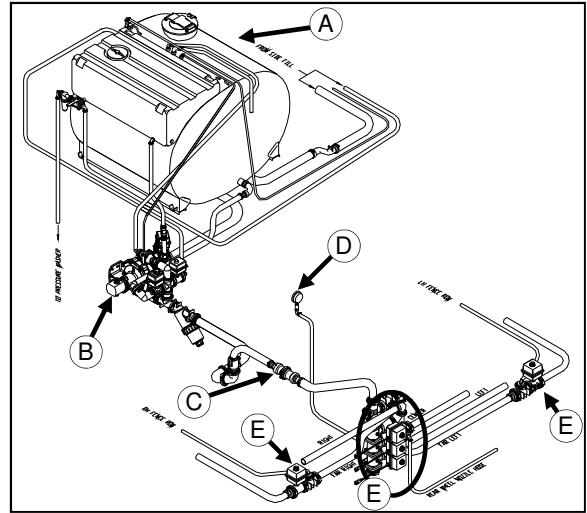

continued on next page

# SPRAY SYSTEM

- F. Sump valve
- G. Solution tank valve
- H. Solution tank valve switch
- I. Agitation switch
- J. Individual spray control switches
- K. Main solution spray control switch

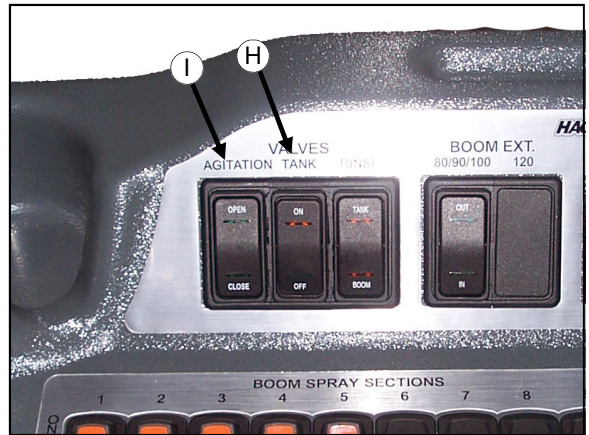
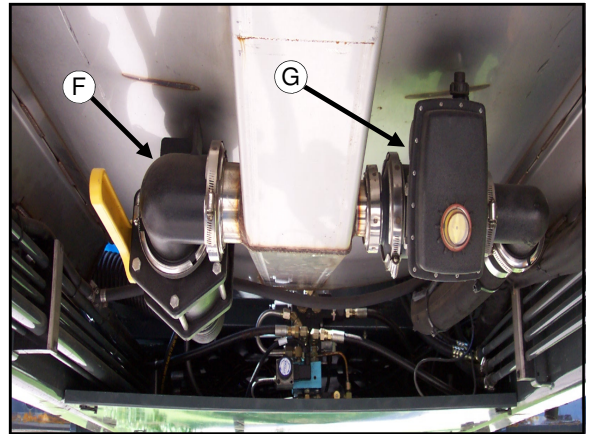

# SPRAY SYSTEM

## Solution Tank

The solution tank (B) is a 1400 gallon stainless steel tank. The tank has a variable sparge type agitation system.



# SPRAY SYSTEM

## Solution Pump

The solution pump (A) is a centrifugal type hydraulic pump that is controlled by the Pulse Width Modulated Valve (B) and the Raven console (C). The pump draws the solution out of the tank at the rate determined during the calibration of the Raven console. It dispenses it through the many valves and hoses that make up the spray system. The pump also dispenses fluids through the agitation system and the rinse systems.

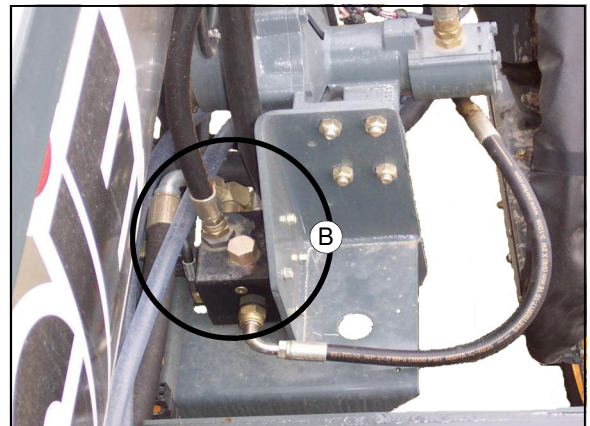
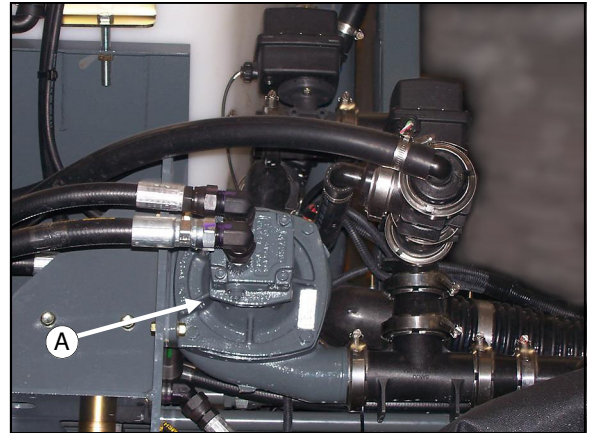

# SPRAY SYSTEM

## Flow Meter

The flow meter located in the main solution line monitors the solution flow and sends information back to the console and control valve. If the flow rate is not within the parameters programmed, the control valve will compensate by either opening or closing. If the rate continues to be outside the parameters, an alarm will sound signaling a low flow rate. (see the Raven console guide for more information on low flow limit)

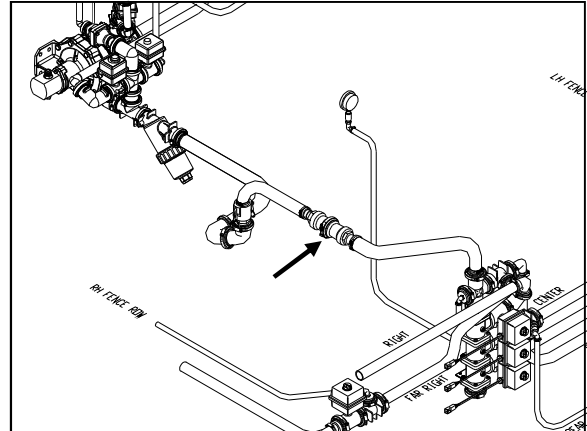

## Solution Pressure Gauge

The pressure gauge gives you a constant visual display of the amount of the solution being applied (measured in PSI). The pressure, as determined by the pulse width modulated control valve, will vary according to ground speed. If applying solution manually, the solution pressure gauge visually informs the operator of needed manual adjustments. The gauge also shows when there is a drop in pressure indicating that the solution tank maybe empty or there is a problem with the system.

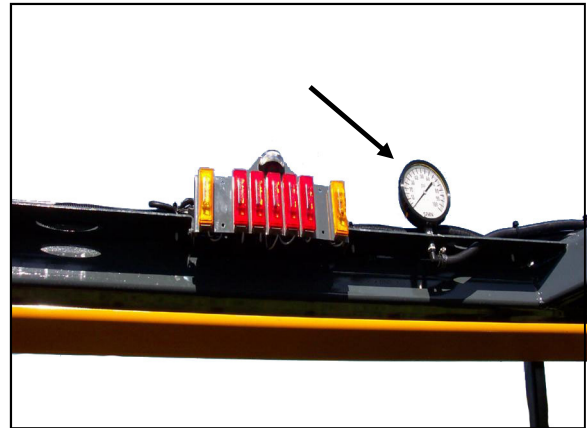

# SPRAY SYSTEM

## Individual Boom Solution Valve Switches

The spray booms are divided into sections that are independently supplied with solution and can therefore be shut off or turned on independently. The hydro-electric boom solution valves are controlled by a row of switches mounted on the right hand console (A).

Sixty foot boom configurations are divided into three sections and the valves are mounted on the transom. Eighty and ninety foot booms are divided into five sections with three of the valves mounted on the transom and one on each boom.

## Boom Solution Valve L.E.D. Indicators

Boom solution valve status is displayed on the transom by a series of L.E.D. indicators (B). Each indicator will illuminate if that particular boom solution valve is turned **OFF**.

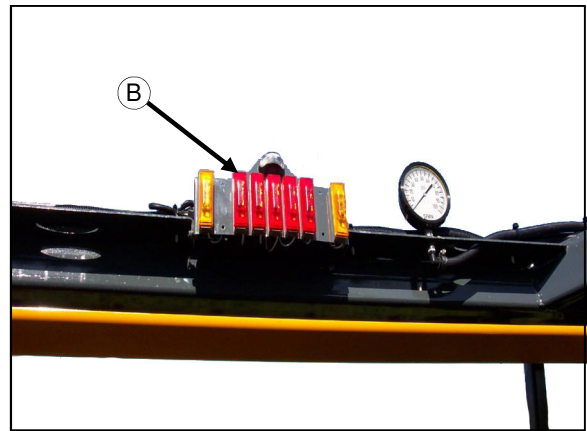

# SPRAY SYSTEM

## Solution Tank Valve

The solution tank valve (A) controls the amount of solution coming out of the tank. The valve is controlled from inside the cab with the TANK VALVE switch (B) located on the right hand console.

## Tank Sump Valve

The tank sump valve (C) is a ball type valve that has to be turned on and off manually. This valve is to allow the fluid into the tank from the fill option.

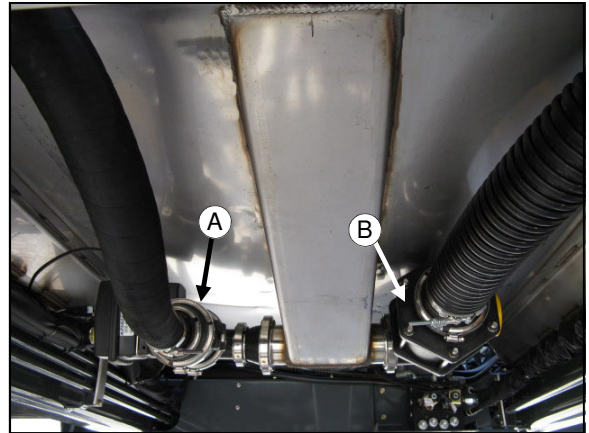

# SPRAY SYSTEM

## Agitation

The speed of the sparge agitation system (stainless steel tank option) or the eductor agitation system (poly tank option) is controlled by a variable flow solution valve (A) mounted on the solution pump (B). The agitation switch (C) on the right hand console controls the rate of flow through the sparge system. While watching the indicator on the agitation valve, increase or decrease the flow rate with the control switch. To increase the flow, press the switch up. To decrease the flow press the switch down. When the desired rate of flow is achieved, release the switch.

To turn the agitation system off, decrease the flow rate all the way down.

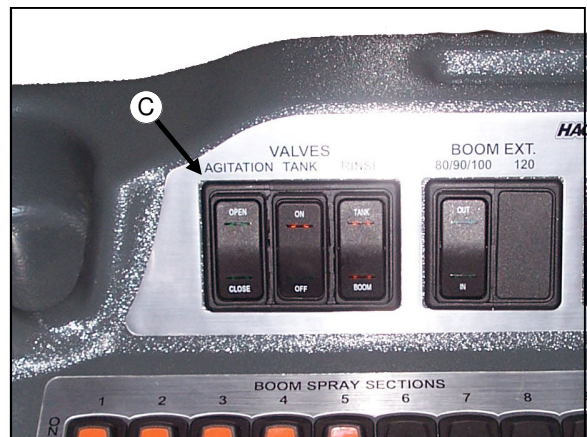
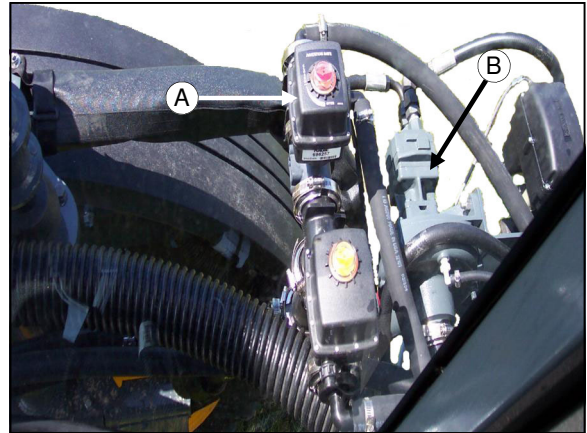



# SPRAY SYSTEM

## Main Solution Switch

Main spray power can be controlled from a switch on the hydrostatic lever (A). This controls the panel of boom solution valve switches. The main switch must be on to supply the individual switches with voltage. This allows you to turn all of the boom solution valve ON or OFF at the same time such as turning them off when you arrive at the end rows and turning them back on when you re-enter the field. The individual switches allow you to turn the valves ON or OFF separately.

When the main spray power is ON a green indicator light located on the left side of the MD3 (B) above the tachometer reading will illuminate and a white indicator light (C) mounted on the transom assembly will also illuminate.

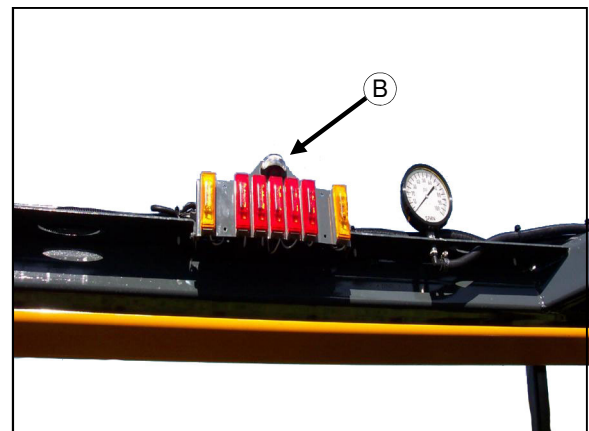

## NOTICE

**DO NOT** allow the pump to keep running when the boom switches are turned off. Failure to do so will generate in over-heating and cause severe pump damage and void the warranty.

# SPRAY SYSTEM

## Solution Quick Fill

To fill the solution tank, make sure the sump valve under the tank (A) is open. To access the front fill, pull the front fill latch lever out (B) and lower the assembly. Connect your solution supply to the front fill and fill to the desired level.

You may also fill the rinse tank (C) from the ground level with an owner supplied connection. When finished, shut off all of the valves and return the front fill to the locked position. See the next page for information regarding the use of the side fill inductor for filling the solution tank.



**Caution:** Wear the appropriate clothing and protective gear when working with agricultural chemicals. Do not store the clothing inside the cab.

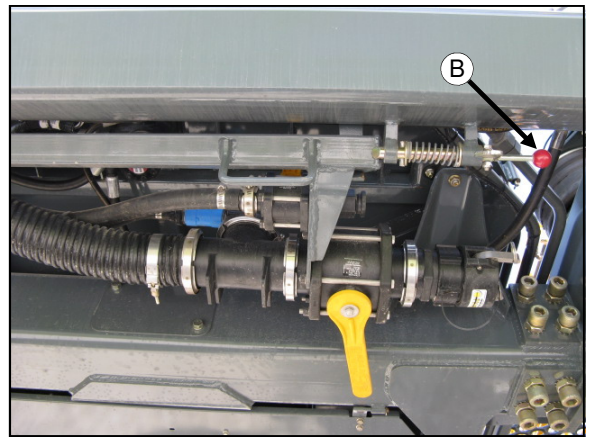
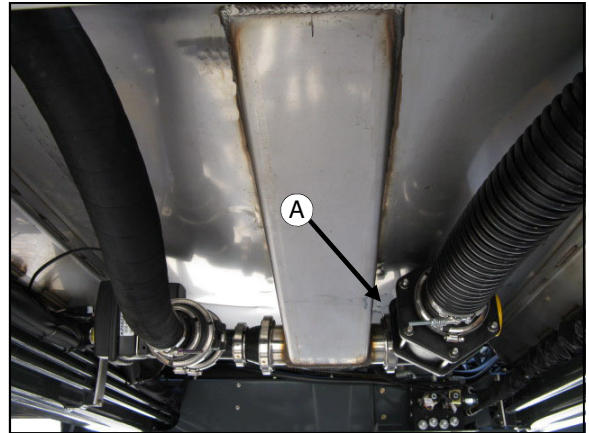

# SPRAY SYSTEM

## Inductor Operation

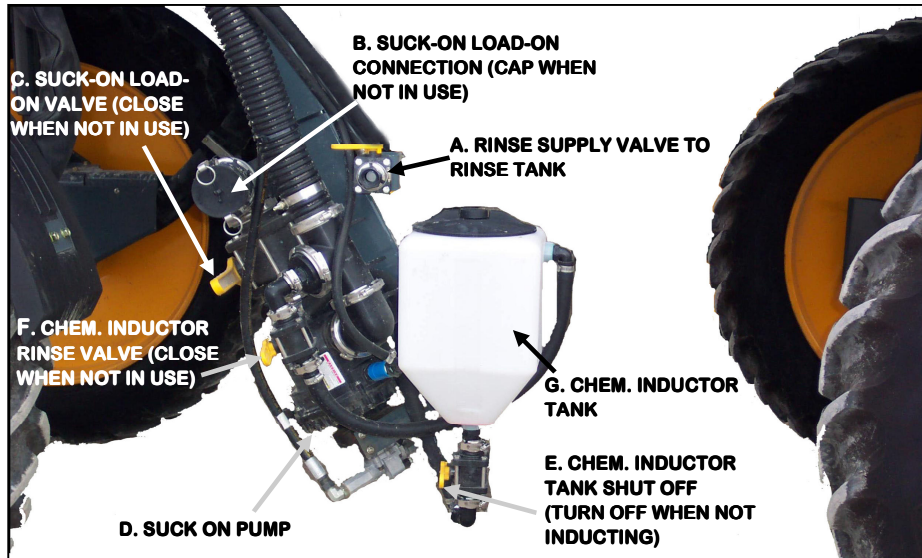

With the engine running and the parking brake set, flip the lock switch up (H). Lower the inductor assembly with the inductor control box switch (I). If filling with the suck-on attachment, leave the engine running. If filling with the push-on attachment, turn the engine off.

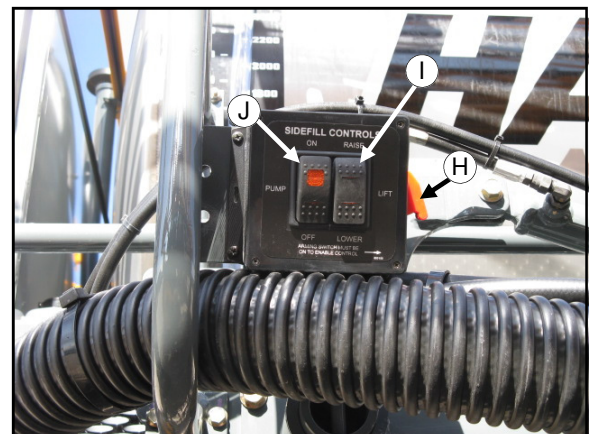

**Load water only:** B-connected, C-on, E-off, F-off

**Suck water only\*:** B-connected, C-on, E-off, F-off

**Load water/induct chem.:** B-connected, E-open, F-off

**Suck water/induct chem.\*:** B-connected, E-open, F-off

**Fill rinse tank (K):** A-handle perpendicular to sprayer

**Rinse inductor tank rinse tank:** F-valve on

**Rinse inductor tank with nurse tank (suck or load):** F-valve ON, E-valve ON



\*To activate "suck on" pump, flip the inductor control switch up (J). This will start the pump. Flip the switch down when filling is complete.

# SPRAY SYSTEM

## Fence Row Applicator

To operate the fence row nozzle, locate the fence row switch on the console (A). If you wish to turn the right fence row nozzle, depress the top of the fence row switch. To turn on the left fence row nozzle, depress the bottom of the switch. To turn either fence row nozzle off, return the switch to the center position.

As you engage either fence row you may notice a drop in solution pressure.

A pair of amber L.E.D lights mounted on the transom (B), on either side of the boom solution valve indicator lights, will inform the operator of fence row status. If the left fence row nozzle is ON, the left amber L.E.D light will be on. If the right fence row nozzle is ON, the right amber L.E.D light will be on. If neither amber L.E.D light is on, there is no solution being applied through the fence row nozzles.

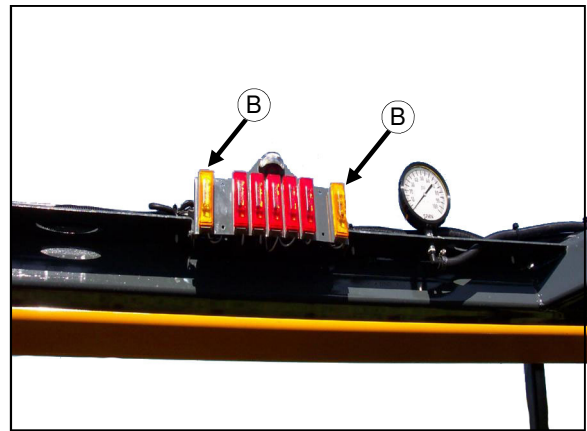

# SPRAY SYSTEM

## Hand Washing System

Fill the hand wash tank (A) with fresh water only!

The hand wash valve is located under the left side of the sprayer (B). Remember to close the valve before refilling.



**NOTICE**  
**FILL WITH FRESH  
WATER ONLY**

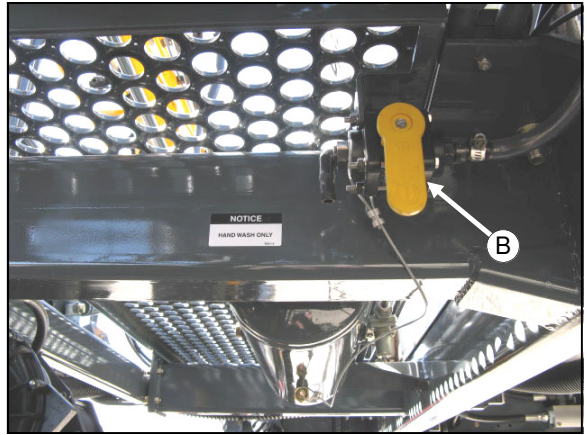

**NOTICE**  
**HAND WASH ONLY**

# SPRAY SYSTEM

## Rinse System

Activate the rinse system only after the solution tank is empty. Select a safe area to rinse spray system and clean sprayer where the chemicals will not drift off to contaminate people, animals, vegetation, or water supply. Refer to chemicals manufacturer's guide for types of cleaning solution combinations (plain water, cleaning agents, etc.).

TO RINSE THE SOLUTION TANK AND 3" FILL LINES:

1. Turn on the spray system console.
2. Turn the rate switch to the MANUAL position.
3. Using the flow increase/decrease lever (A), increase the solution pressure to maximum PSI.
4. Close the solution tank valve (C).
5. Depress the "SOLU TANK" rinse switch (D).
6. When finished rinsing the solution tank, return the switch back to the OFF position and turn the spray system OFF (including the solution pump switch, and the console).

TO RINSE THE BOOM SUPPLY AND NOZZLES:

1. Follow steps 1 through 4 from above.
2. Turn agitation OFF (B).
3. Close the solution tank valve (C) and open the boom supply valves (E).
4. Depress the boom rinse switch (C)
5. When finished rinsing the boom, return the rinse switch back to the OFF position and turn the spray system OFF (including the solution pump, console, boom solution valves, and main spray power switch).



# FOAM MARKER SYSTEM

## Foam Marker Operation

To operate the foam marking system, locate the toggle switch on the top of the hydrostatic lever (A). Push the switch left if foam is desired from the left foam drop. Push the switch right if foam is desired from the right foam drop. Return the switch to the center position if no foam is desired.

System pressure is indicated by a pressure gauge on the regulator which is mounted next to the foam tank (B). To adjust the air pressure in the foam tank, turn the knob on the regulator clockwise for more pressure, and counterclockwise for less pressure. To correctly decrease pressure in the foam tank, you must first open either the left or right foam valve for a moment to relieve system pressure. Then adjust the regulator accordingly.

See illustration for foam drop configurations.

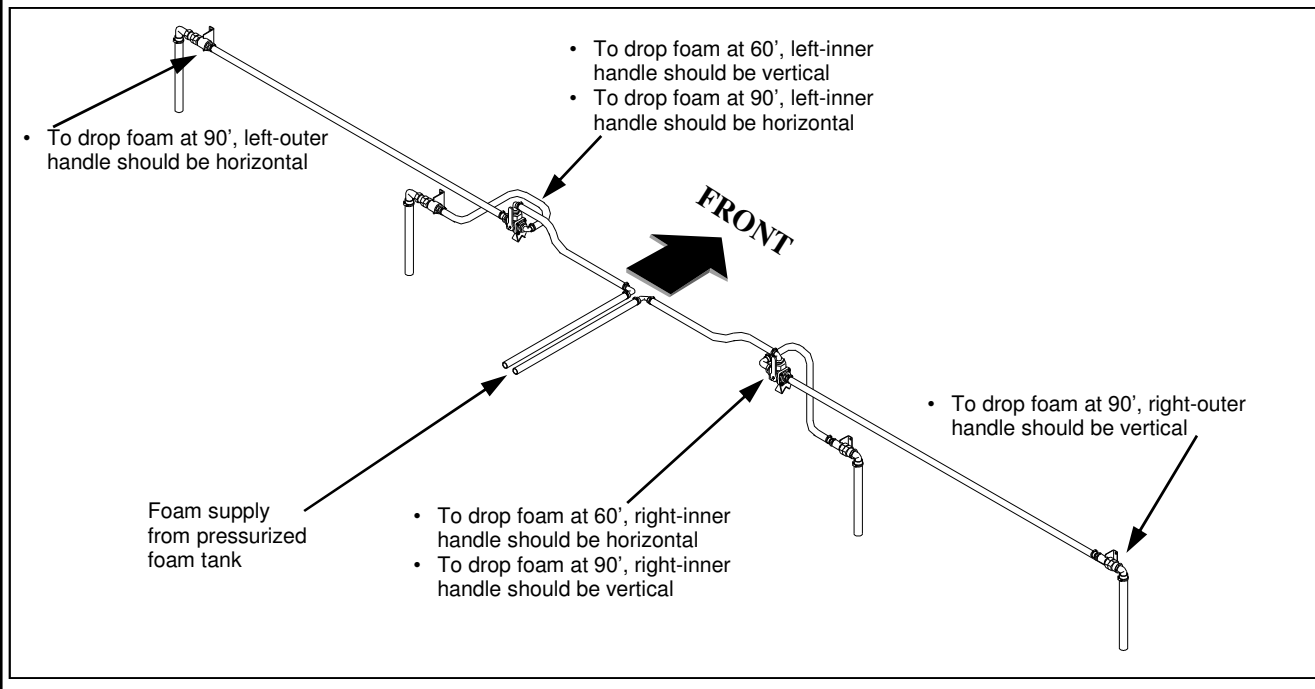

# FOAM MARKER SYSTEM

## Filling the Foam Marker Tank

1. Relieve the pressure from the foam marker tank by opening the ¼" ball valve on the side of the foam marker tank (B).
2. Close the ball valve after the pressure is relieved.
3. Open the top 2" ball valve (A).
4. Add water to the tank, leaving enough room for the foam concentrate.
5. Next add the foam concentrate according to the label on the container.
6. After filling is complete, close the 2" ball valve on the top of the tank.
7. Start the sprayer 's engine and adjust the air pressure accordingly (see previous page).

**!** **Caution:** Before performing any service on or refilling of the foam marker, shut the engine off and relieve system pressure from the tank.

**!** **Warning:** DO NOT stand directly over or in front of the valves when opening.





# QUICK-TACH SYSTEM

The Hagie “Quick-tach” system is a convenient way of changing between sprayer attachments.

## Removing the boom

1. Determine where to place the boom once it is off the machine.
2. Lower the boom and secure the boom stands on the down position.
3. With the booms folded, horizontally fold the booms so that the folded tip is approximately even with the rear of the cab.
4. Disengage the quick-tach lock assemblies.
5. Slowly and gently lower the boom and transom assembly until the quick-tach hook is free of the lock pin.
6. Make sure the solution valves are OFF and turn off the engine before disconnecting any hoses or electrical lines.
7. Once you have cleared the lock pin, unhook the hydraulic, solution, electrical, and foam marker lines (if equipped), being careful not to leave the ends in a place that they may get damaged or contaminated.
8. If no other attachment is going to be installed, re-lock the quick-tach lock assembly to keep it safe from damage. Be sure to unlock it again when installing an attachment.
9. Start the machine and slowly back out and away from the boom. Alarms will sound notifying you of modules being offline, accept the warnings on the MD3.



# QUICK-TACH SYSTEM

## Storage

When looking for a place to store the boom, there are three important things to consider:

1. **Level ground:** The ground must be relatively level to help prevent tip over. Look at the ground in all directions. Level ground will also minimize stress on the frame of the attachment while in storage.
2. **Space:** The boom option has to be partially open in order for it to stand properly. Make sure that there is adequate room to allow for the boom.
3. **Accessibility:** Make sure that there is enough room that the boom is not blocking anything or is blocked.

If temporarily storing the boom on a soft surface, such as grass, it may be necessary to put blocks under the stand's feet to prevent the attachment from sinking into the ground. It is not recommended that booms be stored on a soft surface for an extended period of time because of the risk of the soil settling even when blocks are used.



# QUICK-TACH SYSTEM

## Boom Stands

If the boom option is equipped with boom stands, there are two on the transom and one on each of the inner sections of the boom. Boom stands are an option and therefore may not be on the boom. Contact Hagie Customer Service Department to order stands.

The stands are brackets attached to the end of the first boom section on both the left and right boom and two on the transom. Each stand has a "leg" with a "foot" on the bottom. Each has a hex bolt in the top hole of the leg to secure it from sliding off, and a snap lock pin in the hole directly below the bracket to maintain its position.

Do not leave the stands in the lowered position at anytime while moving the boom. Damage may occur to the boom if the stand were to catch uneven ground or an unseen object. Raise the foot all the way up and place the pin in the hole above the bracket.

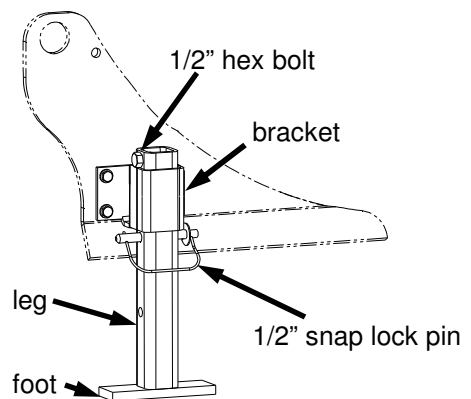
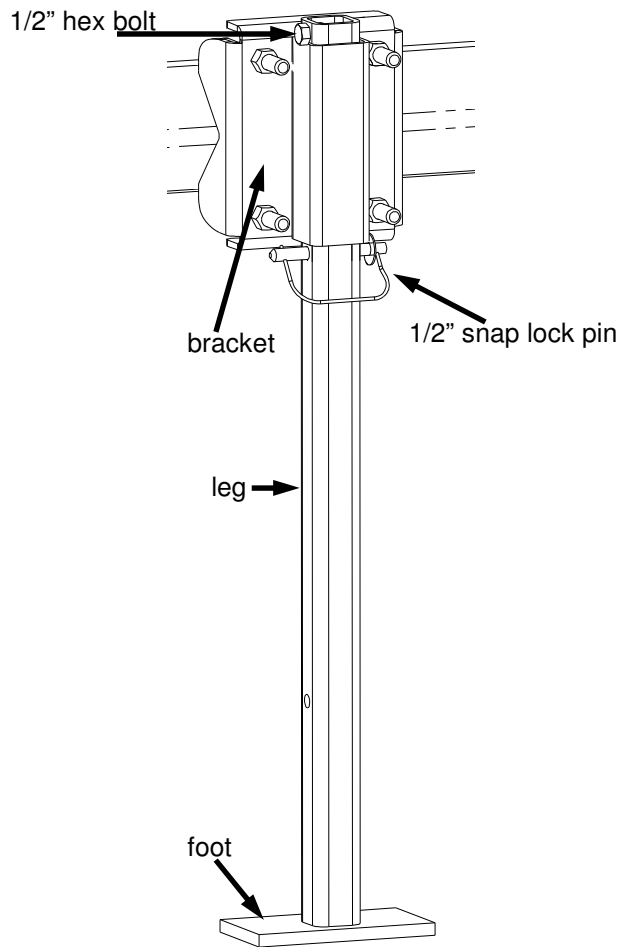
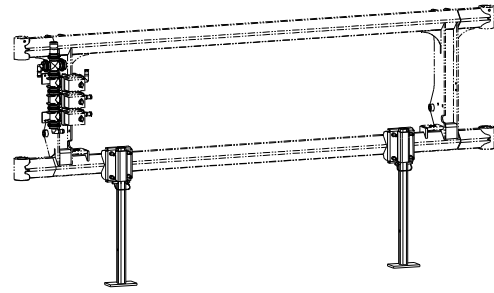

# QUICK-TACH SYSTEM

## Opening the Boom

The booms must be partially open for stability while unattached from the machine. Unfold the booms to approximately 45° while maintaining sufficient clearance for repositioning during reattachment.

This position will allow the booms to sit level with the transom without causing too much stress on either part. It will also keep the weight from shifting too much either way (rearward or forward) which could cause the boom to tip over or be difficult to connect or disconnect.

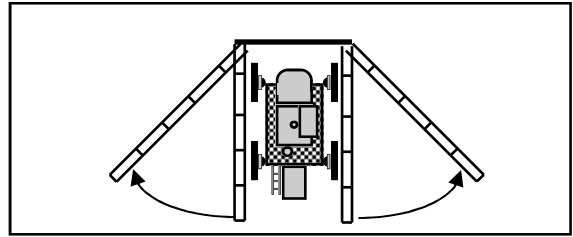

## Disengage the Lock Assembly

Disengage the lock pin assembly only after the boom has been lowered the close to the ground.

To disengage the lock assembly, pull the pin out as far as it will go. Once the pin is out as far as it will go, it should lock in the out position. Make sure that the lock assembly does not re-lock while you are trying to remove the boom.



## Lower the Boom to the Ground

Slowly, and gently ease the boom to the ground. Continue to lower the boom until the quick attach hooks have cleared the lock pin.

A “bounce back” effect may be felt when the weight of the boom has been relieved from the machine. Once the airbags have cycled, the machine will adjust to the new weight.



# QUICK-TACH SYSTEM

## Disconnect Solution, Electrical, and Hydraulic Lines

Once the lock pin has been cleared, all hoses and electrical lines must be disconnected.

Make sure that the solution valve is OFF. There may be a small amount of solution leak out. If it doesn't stop or is excessive, check the valve switch. If the switch is off, contact Hagie Customer Service Department for repair or parts.

A machine may have six points of disconnection from the boom: the electrical pigtail on the right hand side of the machine (A); three hydraulic disconnects on the left side of the machine (B); the rear wheel nozzle (solution) on the right side (C); and the main solution disconnect on the right side of the machine, above the front wheel (D). If the machine is equipped with the foam marker option, there are two hoses near the electrical pigtail to disconnect (E).

Remember to use the caps that are provided for the hoses. If the cap is missing, cover the opening with a plastic bag secured with tape until a replacement can be ordered from Hagie Customer Service Department (see Parts Manual). Hoses may also be able to be connected together. Do not connect hoses that have different solution flowing through them.

Pull away from the boom after everything is disconnected. The lift arms will hold position because of an auto-block that keeps pressure in the lift cylinders.

**!** **WARNING:** Turn the engine OFF before disconnecting any hoses or electrical lines! Failure to do so may result in serious injury or death.

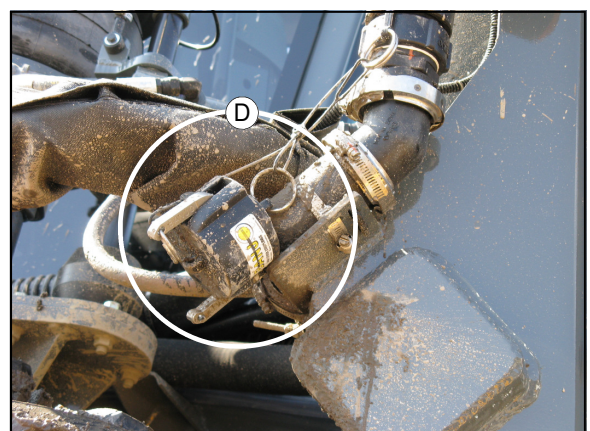
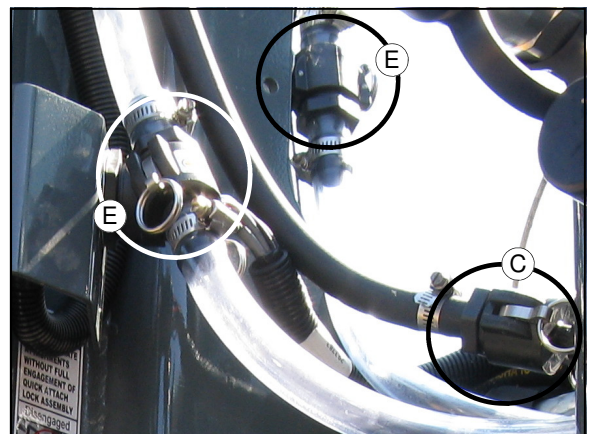
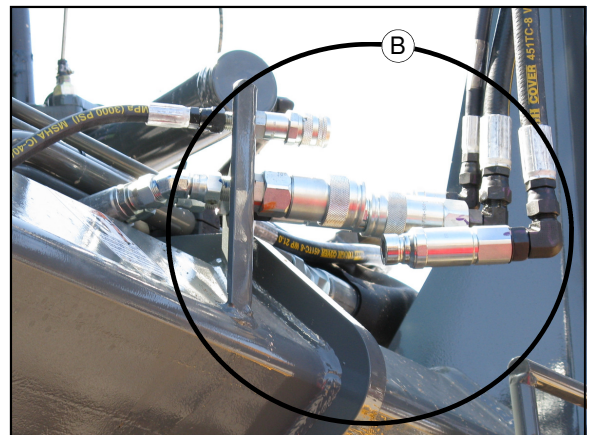
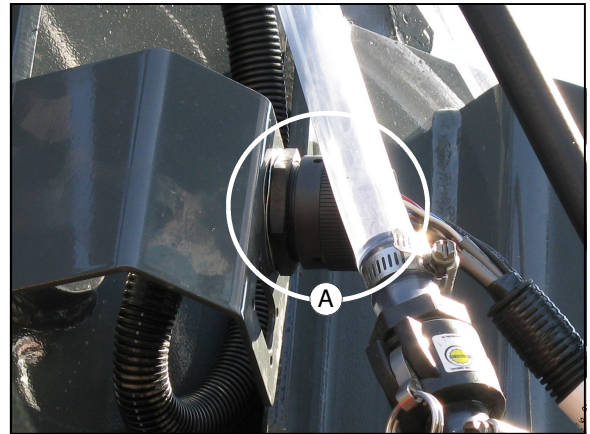

# QUICK-TACH SYSTEM

## Connecting the Boom

1. Square up to the boom. Make sure the quick attach lock assemblies are open.
2. Pull into the boom *slowly*.
3. After squarely pulling into the boom, check to see that the quick-tach hooks are high enough to go over the lock pins. If the hooks are high enough, no adjustments need to be made to the machine. Continue to pull into the boom until the hook openings are above the lock pins.
4. Turn the engine OFF before connecting any hoses or electrical lines.
5. Re-attach all solution, electrical, hydraulic, and foam marker lines (if equipped). If you are attaching to something other than the boom, be sure you read and understand the operator's manual for the attachment.
6. Start the machine. Lift the boom until the hooks have fully engaged.
7. Lock the quick-tach lock assemblies. Be sure that the assembly is fully engaged!
8. Put the boom stands in the "travel position".
9. Continue with your spray job.

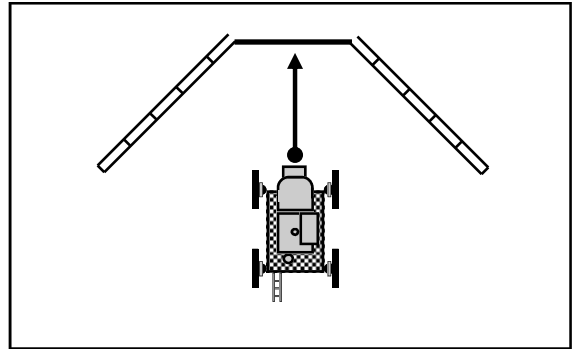

# QUICK-TACH SYSTEM

## **Pull Into the Attachment**

Slowly pull into the boom.

A helpful tip to pulling into the boom— use the speed control. Set the speed control to the slowest speed rather than trying to control it with the hydrostatic lever. (see the Hydrostatic system section for information on the speed control)

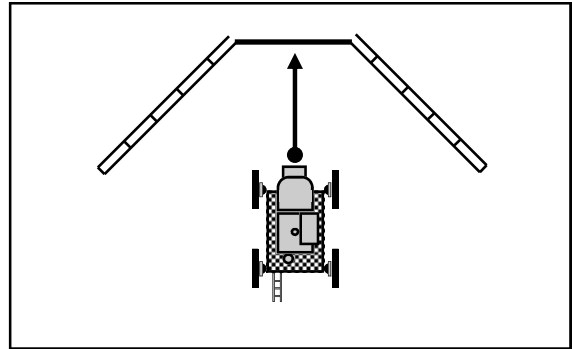

## **Is There Enough Clearance?**

Check to see that the quick-tach hooks are high enough to clear the lock pins. Due to soil settling or the difference in the airbag pressure without the boom on, you may need to let some air out of the airbags using the relief valves. If the machine is not equipped with the valves, call Hagie Customer Service and purchase airbag relief valve kits and install them on the front leg assemblies.

Once the necessary adjustments have been made, continue to drive into the boom until the hooks are above the lock pins.



## **Reconnect All Hydraulic, Electrical, Solution, and Foam Marker (if equipped) lines**

Reconnect all the necessary lines between the machine and the boom. If connecting to another attachment other than the boom, make sure that you read and understand the operator's and parts manuals for the attachment.



# QUICK-TACH SYSTEM

## Lift the Boom

Lifting the boom will allow the weight of the boom to pull the hooks over the lock pins. Once the hooks are fully over the lock pins, be sure to engage the lock assemblies. **Do not operate the boom without the full engagement of the lock assemblies!**

You will notice the change of weight again as the machine begins to support the boom.





# QUICK-TACH SYSTEM

## Boom Stands

This would also be a good time to put the boom stands (if equipped) in “travel” position by removing the pin and sliding the leg all the way up. Re-insert the pin above the bracket to keep the leg in place.

Do not try to move the machine a great distance without doing this step! There is risk of catching the stands on the ground causing unnecessary damage to the stands and to the boom. This may also damage the machine.



## Continue With the Spray Job

DO NOT FORGET to adjust the booms before moving the machine. Continue with your spray job.



# ALL WHEEL STEER <sup>▲</sup>



## Introduction

It is very important that you study this section if AWS (All Wheel Steer) is installed on the machine.

The AWS system is set up to keep the machine safe, however, each driver's experience behind the wheel of a Hagie Machine may be different. Hagie Manufacturing Company strongly suggests driving a machine in Conventional Steer initially to get a feel of the machine. Get a feel for how different the machine turns at different speeds and at different steering angles in both forward and reverse. It would probably be in your best interest to make sure you are very comfortable in driving the machine on the road and in the field, with the booms in the transport position and in the spray position, and by doing a lot of different turning scenarios before attempting to drive the machine with the AWS.

After all of the test driving is done and you feel comfortable with the machine, you can begin to un-

derstand how to put the machine into an AWS state.

Hagie Manufacturing uses the term "Coordinated Steering" to describe the AWS feature. Coordinated Steering refers to the situation created when the front wheels turn one direction and the rear wheels turn in the opposite direction to create tighter turn angle and allow the rear wheels to follow the front wheel tracks. Coordinated Steering should make turning more efficient and less damaging to your crops.

<sup>▲</sup> Operators with machines equipped with All Wheel Steer pay special attention!

# Progressive **AWS**

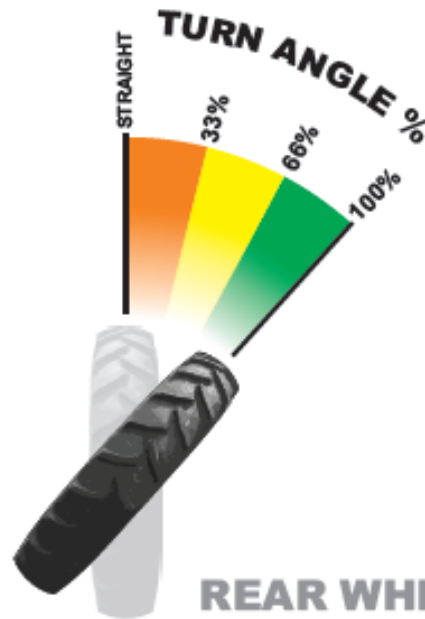

## What is Progressive AWS?

Hagie's New Progressive AWS takes the original design and increases the active speed range while maintaining a safe turning radius. This is done by limiting how far the rear wheels will turn at higher speeds. The improvement allows operators to follow contours in the field and leave only one set of wheel tracks. This also allows them to make wide turns on end rows with only one set of wheel tracks.

## What does this mean in simple terms?

The faster you go the less your wheels will track on hard turns. Your rear wheels will track a perfect match, with limitations on speed and turning percentage. This is completely variable, so if you accelerate in a turn your match on the rear will slowly come out. This is all set to keep the sprayer safe in the turns.

**If you want it to match all the time you might need to slow down a bit or make a less drastic turn.**

## REAR WHEEL TRACKING CHART

This chart will show you the limits of the rear wheel matching or single set of tracks. Using the Turn Angle % chart (above) you will see the % of turn, imagining that is your front inside turning wheel. The chart below will show you at what speed it will keep your rear wheel matching your front (AWS MATCH). If you exceed that speed at that angle it will **NO LONGER** track. This means it will not be a single set of tracks.



<b>SPEED RANGE</b>	1	2	2	2	2	3
<b>TURN ANGLE</b>	100%	100%	66%	33%	AWS	AWS
<b>TRACK</b>	MATCH	MATCH	MATCH	MATCH	OFF	OFF
<b>TIRE 46"</b>	6.92	7.4	8.83	9.79	11.94	18.92
<b>54"</b>	6.93	7.4	9.1	10.1	13.3	21.1
	<b>SPEED</b>	<b>SPEED</b>	<b>SPEED</b>	<b>SPEED</b>	<b>SPEED</b>	<b>SPEED</b>



<b>SPEED RANGE</b>	1	2	2	2	2	3
<b>TURN ANGLE</b>	100%	100%	66%	33%	AWS	AWS
<b>TRACK</b>	MATCH	MATCH	MATCH	MATCH	OFF	OFF
<b>TIRE 46"</b>	6.94	7.4	8.4	9.3	10.7	17
<b>54"</b>	6.92	7.4	8.8	9.8	11.9	19
	<b>SPEED</b>	<b>SPEED</b>	<b>SPEED</b>	<b>SPEED</b>	<b>SPEED</b>	<b>SPEED</b>



<b>SPEED RANGE</b>	1	2	2	2	3	4
<b>TURN ANGLE</b>	100%	100%	66%	33%	AWS	AWS
<b>TRACK</b>	MATCH	MATCH	MATCH	MATCH	OFF	OFF
<b>TIRE 46"</b>	7	7.5	9.1	10	13	18
<b>54"</b>	7	7.5	9.3	10	14.5	20.1
	<b>SPEED</b>	<b>SPEED</b>	<b>SPEED</b>	<b>SPEED</b>	<b>SPEED</b>	<b>SPEED</b>

## A couple of example cases of what these percentages mean:

### CASE A:

A customer wants to do contour rows, but wants to spray at 10 mph with a STS 10 and 54" tires. What this means is that as the steering wheel is adjusting the front wheels, the rear wheels will only turn to a maximum of 33% and thus only follow the front tire tracks to that value as well. If the rows take more than a 33% turn to follow, the rear wheels will probably be running over crop unless the customer slows down a little to gain back some more turn angle on the rear wheels.

### CASE B:

A customer wants to turn on the ends at 8.8 mph with his STS 10 and 46" tires, but also wants the two wheel track pattern. This will now be allowed as long as this customer does not turn his front wheels more than 66% of the maximum turn angle. If the customer happens to speed up past 8.8 mph, the rear wheel turn angle will reduce automatically and the front and rear tire track will no longer match.

## AVAILABILITY:

The New Progressive AWS is available on all 2010 models with the AWS option.



800-247-4885

hagie.com

# ALL WHEEL STEER <sup>▲</sup>

## Terminology

**Conventional Steering**– only the front wheels turn

**Coordinated Steering**– all wheels turn and do so in a relationship to where the rear tire should follow in the front tires' tracks

**Drive State (Road vs. Field)**- this is controlled by through the MD3 (F1 button) (the machine must be in neutral for these drive state to be changed)

**Steering State (Coordinated Steering vs. Conventional Steering)**- this is controlled by several things, but first the AWS must be engaged through the MD3 (F3 button)

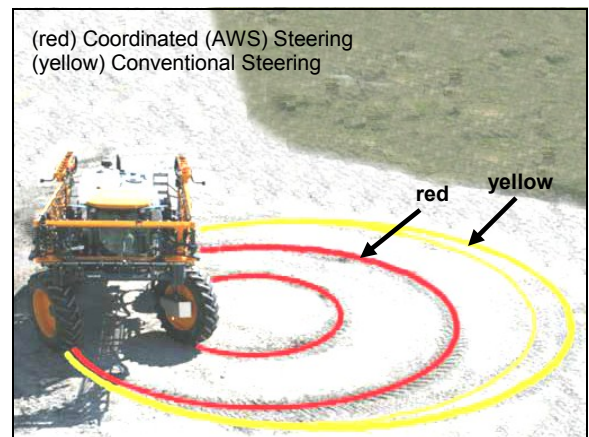
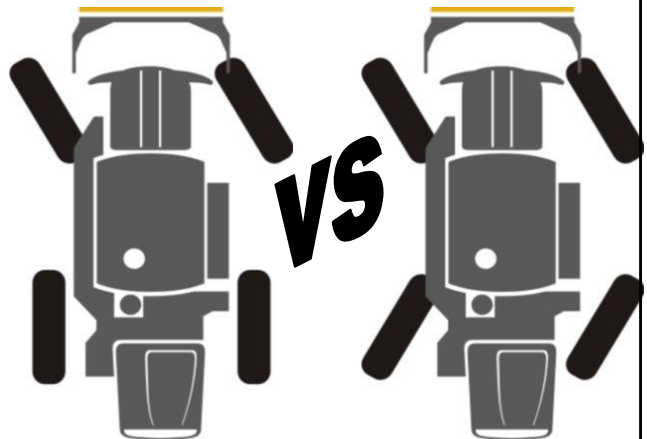

<sup>▲</sup> Operators with machines equipped with All Wheel Steer pay special attention!

# ALL WHEEL STEER <sup>▲</sup>

## Components

The rear legs of an AWS machine are equipped with steering cylinders (A). The cylinders have internal position sensors and external proximity sensors (B) to track the rod extension of the cylinder.

The rear hydraulic steering is controlled by a valve block (C) located on the belly of the machine.

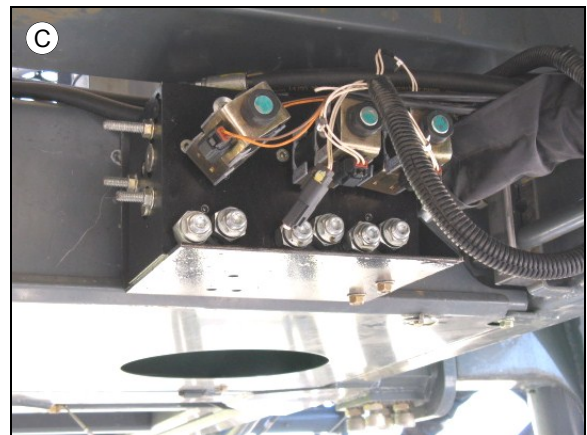
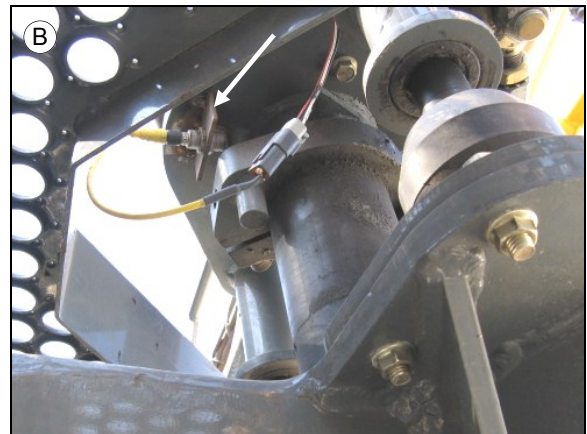

<sup>▲</sup> Operators with machines equipped with All Wheel Steer pay special attention!

# ALL WHEEL STEER <sup>▲</sup>

## Operating All Wheel Steer

To engage the AWS, make sure that the machine's drive state is "field". The machine must also be in the first or second gear (speed range) for AWS to engage. Press the F3 button until "ON" appears beside AWS. The machine will stay in AWS mode, which basically allows the system to be maintained ON until either a limitation in the system is reached or the operator pushes the button to turn it off. Operator can determine whether or not to use the Progressive AWS or not, which basically means that a switch can be activated to only allow AWS in 1st gear or allow AWS in both 1st and 2nd gear. If the AWS is not wanted in 2nd gear then the operator can get to the switch in the MD3 display by pressing the Menu button and then the F1 (Adjust) button. The operator will then see the adjust groups. Scroll to operator adjustments and press the OK button on the MD3. Next scroll to the P-AWS switch in the operator adjustments screen and press OK. Now the value of the switch can be changed from a value of 1 which will allow AWS in both 1st and 2nd gear or a value of 0 which will only allow AWS in 1st gear.

Limitations include:

- Machine is shifted out of first or second speed ranges while in field drive state. Also, the machine limitation is met while in second gear. There is no warning message associated with this, the machine will just automatically switch to conventional steering (normal).

(Continued on next page)



<sup>▲</sup> Operators with machines equipped with All Wheel Steer pay special attention!

# ALL WHEEL STEER <sup>▲</sup>

## Limitations (continued):

- Machine must be in field drive state. If the machine is in road drive state, then the AWS is off. There is no warning associated with this, the machine will just be in conventional steering mode.
- System fault– system not working properly (sensor malfunction, hydraulic issue, etc. ). A message will appear on the MD3 and the machine may be limited on speed and other functions.
- \*\*\* If a machine has Auto Steer\*\*\* When an Auto Steer system is engaged it will turn the AWS system off and move the rear wheels back to straight.



## Tips

### Recommendations for best operating practices:

1. Try to use the shift buttons to slow down at the end rows. Know that the first speed range in "field state" will get you down to a slow enough speed to turn and you can always use the hydrostatic lever to slow down more if needed. By doing this, you will see how the AWS speeds will not really slow down much more than you would want for turning. If you move the hydrostatic lever first and then shift down to get to the AWS, you will notice that the machine may slow down more than you wanted to.



continued on next page

<sup>▲</sup> Operators with machines equipped with All Wheel Steer pay special attention!

# ALL WHEEL STEER <sup>▲</sup>

2. Make sure that you understand how the machine feels when the machine is still in a turn and is shifted out of the first or second gear. You will notice that to stay away from these scenarios, you can wait to shift up out of first or second gear until the front wheels are closer to the straight position. The machine will still operate just fine at whatever turn angle that you want to shift out at, but you may feel that this situation is causing operation that you may not want (possibly getting the machine off the line intended because the rear wheels move back to straight position and the total turning radius will change) See figure below to better understand this.
3. Contact Hagie Customer Service with any and all questions you may have regarding the operation of the AWS system.

The two circles represent a full turn with the AWS on. The - - - lines represent the direction the operator wants the front tracks to go (assume that the operator wants to pull the machine back into rows that are running straight up/down with regards to this page). The - · - · lines represent the direction that the front wheels are pointed when the operator shifts up out of AWS speed range. If this occurs, then the rear wheels will shift back to the straight position and the machine will no longer have to two tire tracks ( the two circles). The rear wheels will begin to follow the - - - path during this shift.

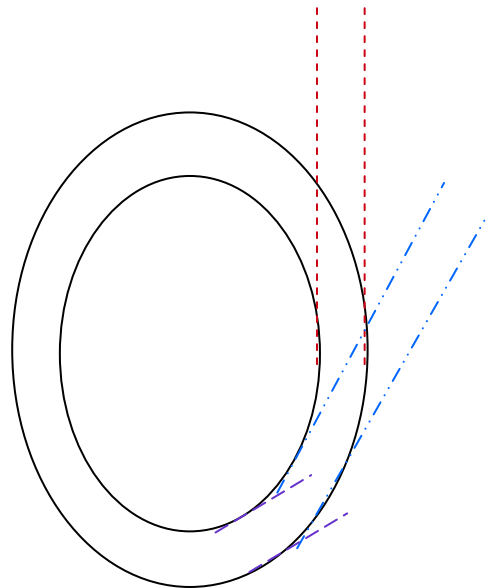

<sup>▲</sup> Operators with machines equipped with All Wheel Steer pay special attention!



# ALL WHEEL STEER <sup>▲</sup>

Hagie Manufacturing Company once again recommends trying this system out before planning on going straight to the first field with it so you can get a feel for what to expect. Some situations to try include:

- Driving the machine with both an empty and a full solution tank with the AWS on.
- Driving the machine on hills– make sure to remember the precautions stated earlier in the manual.
- Driving the machine at different turn angles and speeds to see how the limitations work. You will notice that if you go over any of the limitations that you can slow back down and the system will turn itself back on.
- \*\*\*If the machine has Auto Steer\*\*\*- Notice how the machine feels when in AWS mode and switching from Auto Steer ON to OFF especially when turning.

Hagie Manufacturing Company wants the AWS system to be a great benefit to our customer and would like to hear your feedback.



<sup>▲</sup> Operators with machines equipped with All Wheel Steer pay special attention!

# CE SUPPLEMENT



These decals are located on the left hand rear cab post above the hydraulic leak decal (see above)

These decals represent:

- A. Read the operator's manual.
- B. Refer to the service and maintenance instructions.

(A)



Hagie Part Number: 650248

(B)



Hagie Part Number: 650249

# CE SUPPLEMENT



This decal is located on the underside of the machine near the electrical lock out device.

The decal identifies the electrical lock out point of the machine. Refer to the operator's manual for instructions on how to use the lock out.



Hagie Part Number: 650252

# CE SUPPLEMENT

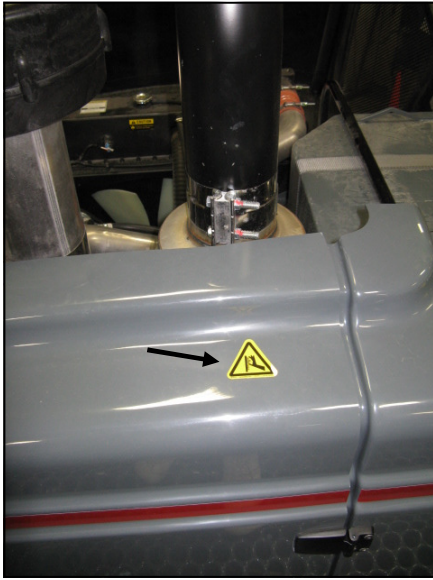

Hagie Part Number: 650255

This decal is located on the top of the engine compartment near the exhaust tube.

The decal is to warn the operator that the exhaust tube may be hot enough to burn. Avoid touching the exhaust tube while the machine is running. Allow the engine plenty of time to cool down before performing any service or maintenance procedures.

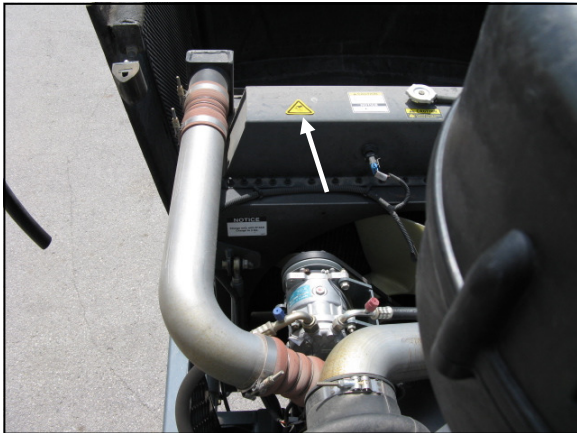

Hagie Part Number: 650257

This decal is located in the engine compartment on the top of the fan guard.

The decal warns the operator that putting their hand beyond the protective guard may result in serious injury from a moving fan blade.

# CE SUPPLEMENT

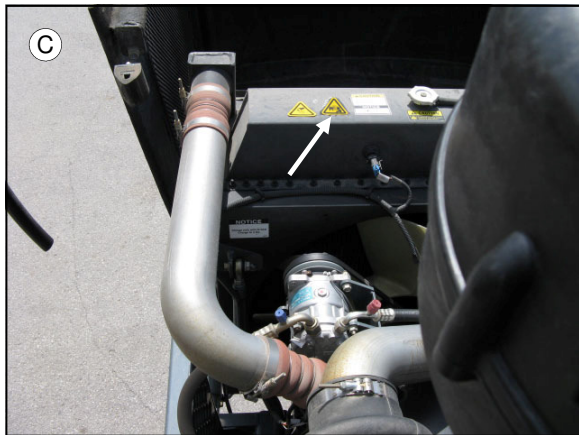
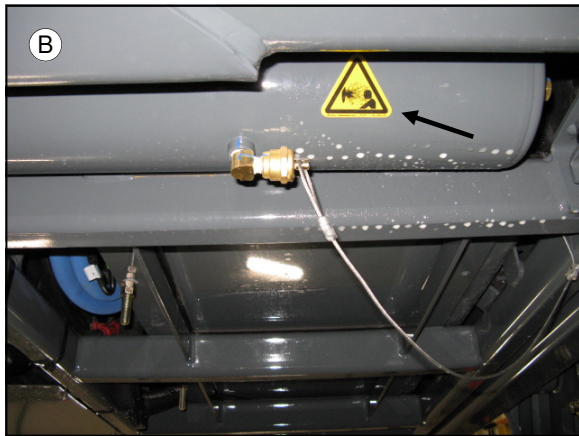

Hagie Part Number: 650256

This decal is located on the air tank (A) and wet tank (B) which are on the underside of the machine. A decal is also located near the radiator cap (C).

The decal warns the operator of the possibility of expulsion of material while servicing. Do not stand in the path of the discharge to avoid possible injury from spray.

# CE SUPPLEMENT

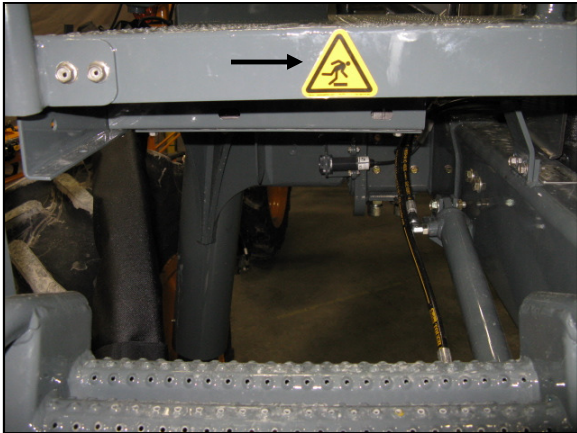

Hagie Part Number: 650260



This decal is located three places on the machine: top of the ladder, and each different level of platforms.

The decal indicates that there is a trip hazard at the top of the ladder. Use caution when climbing onto the machine and walking on the service platforms.

# CE SUPPLEMENT

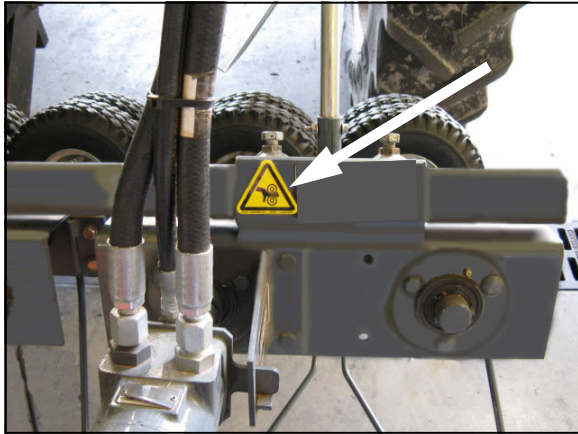

This decal is located on the mounting tube of each puller head.

The decal warns the operator that there is risk of injury from the rotating tires. Never attempt to perform any service or maintenance on the pullers while they are rotating! Never attempt to dislodge a wedged object from the pullers with your hand!



Hagie Part Number: 650259

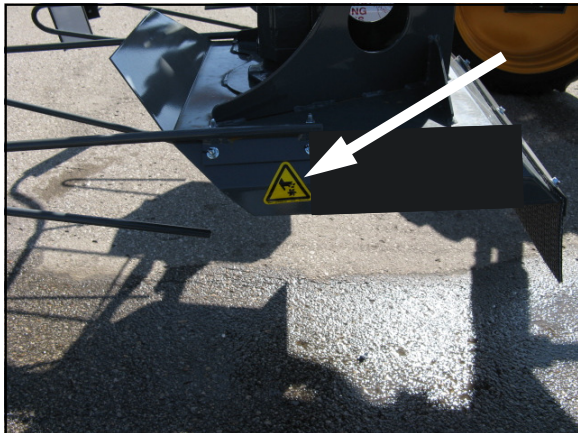

This decal is located on both sides of the cutter head assemblies.

The decal warns the operator that putting your hand past the protective guard may result in serious injury by the rotating blade. Never attempt to perform any maintenance on a moving cutting blade or try to stop the blade!



Hagie Part Number: 650258

# CE SUPPLEMENT

## Rotating Beacon

There is a rotating beacon mounted on the left hand side of the operator's station. This light is used for increased visibility to others.

The light will illuminate when the flashing hazard lights are activated.



## E-Stop

The emergency stop is located to the front of the side console. Do not use this button for non-emergency stopping or as a parking brake.

The emergency stop switch provides a quick and positive method for stopping the engine in an emergency situation. When the button is depressed, it locks in position and removes the ignition signal to shutdown the engine. To reset the switch, turn the button in the direction of the arrows on the face of the button.



## Operator Presence Switch

The operator presence switch (OPS) is located in the seat. The switch protects the operator from exposure to moving parts or hazards in regards to the detasseler cutting blades, quad pullers, or spray system by introducing an electrical interlock that ensures that when the operator is out of the cab the operation of these functions is stopped.

This is achieved by using the seat switch to prevent the detasseler assemblies and spray control systems from operating the machine actuators if the operator is not seated for 3 seconds.





# HAGIE REVERSIBLE FAN

## IMPORTANT SAFETY INFORMATION

The safety information in this publication is to be used in conjunction with the safety information supplied from the original machine manufacturer. Please refer to all safety information supplied, prior to doing any work on the Fan Assembly or any other component(s) to assure total safety.

**Improper operation, maintenance or repair of this product can be dangerous and could result in injury or death.**

Always use Hagie approved parts and components. Failure to do so will result in voiding the 1-year parts warranty for the fan.

**Do not operate or perform any maintenance on this product, until you have read and understood the operation and maintenance information. Please contact Hagie Manufacturing Company for any information that you may require.**

The person(s) servicing the product may be unfamiliar with many of the systems or components on the product. This makes it important to use caution when performing any type of service work. Knowledge of the product and/or its components is important before the removal or disassembly of any component.

## PRODUCT SUPPORT

The Customer Support Department provides technical support, information on fan installation and maintenance, parts, instruction manuals, and is responsible for warranty administration. Contact the Hagie Customer Support Department for any problems that this technical manual does not address.

**Phone:800-247-4885**

**Monday to Friday 8:00am to 5:00pm CST**

## FAN SPECIFICATIONS

The following needs to be considered prior to the installation of the Hagie Reversible Fan Option. If your situation is listed in this section, do not install the fan. Damage and/or injury may occur.

## MOUNTING

**Warning:** This fan is not designed to be mounted onto a crank shaft or crank shaft pulley. Torsional vibration from crank shafts will damage the fan and could result in machine damage and serious injury.

### Hagie Reversible Fan

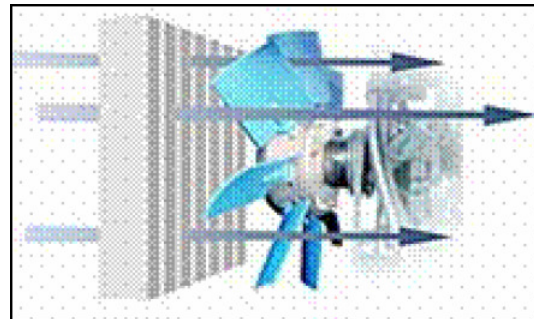

**Cooling Mode**

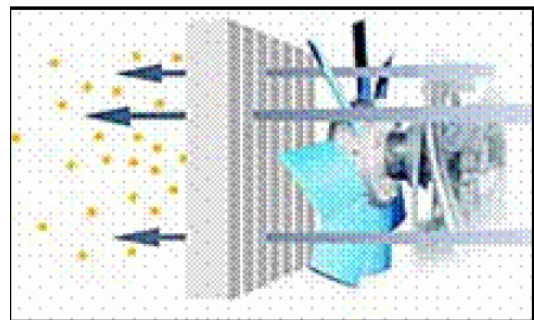

**Cleaning Mode**

## How the *Hagie* Reversible Fan works:

The Hagie Reversible fan is a pneumatically actuated variable pitch fan. The blades are held in full pitch by spring pressure. As air pressure builds, the pitch of the blade changes to the reverse direction. When the pressure is released, the fan blades return to their default cooling position. The *Hagie* fan has a number of inherent features:

- **Fail Safe:** The blades are spring returned to the cooling position. If air pressure is lost the fan will default to cooling position and act just like a fixed pitch fan giving maximum cooling.
- **No oil or hydraulic fluid** that can cause messy leaks that can clog your radiator or cooling system.

# HAGIE REVERSIBLE FAN

## CONTROL KITS

Due to the variability of machines that the Hagie fan can be installed on, for our application we use our own on board air supply reverse the fan hub. Our kit uses a push button control system to reverse the fan hub.

## PNEUMATIC SPECIFICATION

Hagie Manufacturing Company supplies a number of pneumatic control options, but the Hagie Reversible fan can be operated using any air source that meets the general specifications listed below. If your machine has onboard air then this source will be available. If not, then a compressor kit will be required.

### General Specifications

Full Pitch (default cooling position):	0 psi
Reverse pitch (purge position):	70-90 psi
Max intermittent pressure:	120 psi
Max continuous pressure:	100 psi

## SERVICE AND MAINTENANCE

### A. VISUAL INSPECTIONS

Under normal operating conditions, Hagie Reversible fans do not require scheduled maintenance, other than lubrication, and are built to provide thousands of hours of trouble free service. In moderate to extreme operating conditions a visual inspection of the moving parts is recommended from time to time to safeguard against fan blade damage which could lead to equipment and/or other damage.

### B. FAN BLADES

The fan blades are designed to provide thousands of hours of life and typically will last for the life of the fan. Blade wear is largely dependant upon operating conditions. In highly abrasive environments increased blade wear will occur.

### C. LUBRICATION

To keep our fan in peak operating condition it is recommended that the internal components are greased on the following intervals. Note: Frequency may vary with harshness of environment -cycle frequency of 20-min.or less grease every 2500 hrs.

### D. MAINTENANCE CHECK LIST

This check list is to provide some basic information to be used at time of machine delivery and at regular maintenance intervals.

CHECK	YES	NO
Does fan rotate from the Cooling mode to Cleaning mode without obstruction?	<input type="checkbox"/>	<input type="checkbox"/>
Are any of the blades damaged?	<input type="checkbox"/>	<input type="checkbox"/>
Are blades installed in the correct orientation for your application? (clockwise/counter clockwise)	<input type="checkbox"/>	<input type="checkbox"/>
Are correct blades installed? Suction Fan - Blue Blades Blower Fan - Black Blades VP-Series Fan- Red Blades VP-Series Fan CC – Yellow Blades	<input type="checkbox"/>	<input type="checkbox"/>
Are all screens and guards secure?	<input type="checkbox"/>	<input type="checkbox"/>
Are all air lines secured?	<input type="checkbox"/>	<input type="checkbox"/>

## !!CAUTION!!CAUTION!!

### BEFORE STARTING THE MACHINE CHECK THE FOLLOWING:

#### 1. CHECK THE AIR TUBE INLET on the front of the

fan to ensure that it has proper amount of clearance to allow for a non restricted rotation of the fan blades during the pitch change of the fan from Cooling Mode into Cleaning Mode. This can be done with the fan belt still loose. Use the shop air to turn the fan blades into the cleaning mode position. Slowly release the air from the fan hub until the fan blades are exactly half way back to the cooling mode. With the fan blades in this mid position, rotate the fan blades and makes sure that there is at least 5/8" (15-mm) clearance between the air tube inlet and the base of the fan blades (maximum width of blades). If the clearance is less than 5/8" (15-mm) remove the fan from the mounting flange and bend the air tube assembly to provide the clearance required. **NOTE: THE AIR TUBE INLET MAY BECOME BENT DURING SHIPPING AND WILLNEED TO BE EXAMINED BEFORE INSTALLATION TO ENSURE THAT CLEARANCE IS AVAILABLE. PLACE THE DRAWING OF THE AIR TUBE INLET ON TOP OF THE FAN HUB AND CHECK TO SEE THAT THE AIR TUBE MATCHES THE PROFILE OF THE DRAWING.**

# HAGIE REVERSIBLE FAN

2. **MAKE SURE ALL ELECTRICAL WIRES, RADIATOR OVERFLOW TUBES, HYDRAULIC HOSES, ETC.** are firmly secured with tie straps and cannot come in contact with the Hagie Fan or operating area.

3. **MAKE SURE THE RUBBER AIR TUBE SUPPLY LINE** is secured where it enters into the fan shroud. It should not be possible for additional lengths of air tube to enter into the fan shroud where it can be sucked into the rotating fan. If necessary, clamp or tie strap the air supply tube to the shroud.

4. **MAKE SURE THAT THE RUBBER AIRLINE IS PRESSED SECURELY** onto the steel air tube inlet by giving it a strong pull. The tube and clamp when installed correctly will not come back off of the air tube without first cutting the clamp to loosen the tension.

5. **MAKE SURE ALL TOOLS HAVE BEEN REMOVED** from engine compartment including the topside of the radiator and inside of the shroud

5. **MAKE SURE ALL TOOLS HAVE BEEN REMOVED** from engine compartment including the topside of the radiator and inside of the shroud before the fan guards are installed. Obstacles in the path of rotation can interfere with the movement of the fan and can result in damage to the fan blades, fan hub and/or the radiator core.

6. **CHECK THE WATER PUMP BEARING OR FAN MOUNTING BEARING.** Check to ensure that this bearing is in good condition. If the bearing does not turn freely or if there is transverse movement of the bearing, it should be replaced before the Hagie Fan is installed to prevent any imbalance of the fan during operation.

7. **CHECK THE RADIATOR MOUNTING BOLTS AND SHROUD MOUNTING BOLTS** to ensure that the radiator and shroud are firmly secured and unable to move during the operation of the machine. Loose shroud bolts can allow the fan shroud to move into the path of the rotating blades and loose radiator mounting bolts can allow the radiator to flex in position allowing the shroud to come into contact with the rotating fan blades.

8. **MAKE SURE ALL FAN GUARDS HAVE BEEN INSTALLED** and firmly secured into place. The Hagie Reversible fan creates a lot of airflow in both the cooling and cleaning mode operation. The result of this airflow is a strong vacuum effect that can suck items/obstacles that are located inside or around the engine compartment or fan.

9. **CHECK TO ENSURE THE CONTROL PUSH BUTTON IS CONNECTED TO A DEDICATED (SEPARATE) POWER SOURCE** and that the correct amperage & voltage is available. (16-18 amps 12-volt sys.)

10. **DO NOT DISCARD THE FAN SHIPPING BOX.** Keep the box that the fan was shipped in. This box was designed for the fan and can be used in the event that the fan needs to be returned or serviced at the factory.

11. **TO ENSURE MAXIMUM EFFICIENCY OF YOUR NEW HAGIE REVERSIBLE FAN.** Make sure to start with a clean cooling system, free of debris paying particular attention to the stacked cooler core(s).

12. **ACTIVATE REVERSIBLE FAN BY HOLDING MOMENTARY SWITCH** installed next to the park brake switch. If the kit is being installed in an AWS machine mount it in the last section switch hole. (See Figure H and Figure I)



Figure H



Figure I

# RAVEN SPRAY CONTROL CONSOLE

## Introduction

It is important to apply chemicals as recommended by the manufacturer's of the product. In order to do so, the spraying system must be properly calibrated.

Determine the speed at which the sprayer will be driven while applying chemicals. To select the best speed, consider the lay of the land, the condition of the soil, the type of crops, the height of the crop, etc.

Select the nozzle spacing (distance between each nozzle on the spray boom) best suited for the intended spraying job. For help in determining the nozzle spacing and height of the boom, refer to the Spray Product Catalog that accompanies this manual.

There are several types and sizes of nozzles. Select (as recommended by the catalog) and install the type and size of nozzle best suited for the intended spraying job., The type of nozzle will be based on the product being sprayed and the type of crop it is being used on. The size of the nozzles selected will be based upon the speed the sprayer will travel, the nozzle spacing, and the number of gallons per acre that will be applied.

## NOTICE

**The key to an effective spray job starts with the selection of the spray tip!**

Refer to the Spray Product Catalog that accompanies this manual for more information.

## Tip Selection:

There are several things to consider when selecting the type of nozzle needed for the intended spray job. Whatever your personal preference is, be sure that the nozzle complies with the chemical manufacturer's standards for spray control and also any environmental standards that might be in place for your region. (some regions may have restrictions on "drift" control).

Once you have chosen a type of nozzle, you must choose the size of the nozzle. There are **3** main things to consider when choosing the size: **1)** recommendation of gallons per acre, **2)** the speed in which you intend to travel across the field while spraying, **3)** and the nozzle spacing (distance between tips). Refer to the following page for information on how to select a tip size.

## NOTICE

Remember that the performance of the nozzle and the spray system is dependant on the performance of the operator. If the system is operated within the set parameters of the nozzle type and the machine/console set up, you will see greater success with your application. Operating the machine even one or two miles per hour faster or slower than intended will greatly change the outcome of the programmed spray job.

# RAVEN SPRAY CONTROL CONSOLE

Since all tabulations in the catalog are based on spraying water, you will need to use a conversion factor when spraying liquids other than water. This information is found in the Spray Product catalog.

Below is an example of how to choose the proper nozzle:

Joe is spraying 28% nitrogen. The chemical manufacturer recommends that the chemical be sprayed at 20 GPA. Joe knows that he can run his sprayer at 10 MPH across his field. He has a 20 inch nozzle spacing on his booms. Joe has narrowed his tip search to the flat spray tips.

Use the following conversion formula:

**20 GPA (liquid other than water) x 1.13**

**(conversion factor)=22.6 GPA (water)**

Joe determined that he needs an application rate of 22.6 GPA to determine the correct nozzle to apply 28% nitrogen at 20 gallons per acre.

To figure out which nozzle is better for his use, Joe has to figure out the GPM he needs to spray.

$$\text{GPM} = \frac{\text{GPA} \times \text{MPH} \times \text{Spacing}}{5940 \text{ (constant)}} \rightarrow$$

$$\text{GPM} = \frac{22.6 \times 10 \times 20}{5940} \rightarrow \text{GPM} = \frac{4520}{5940} \rightarrow \text{GPM} = 0.76$$

The nozzle that best matches the specifications set by Joe is the TP8008, spraying 22 GPA at a rate of 0.75 GPM. If Joe maintains a constant speed, he should have a successful application.

## FLAT SPRAY TIPS

NOZZLE SIZE	PSI	DROP SIZE		CAP. 1 NOZZLE IN GPM	CAP. 1 NOZZLE IN OZ./MIN	GPA							
		80	110			MPH							
		4	5			6	8	10	12	15	20		
TP8004	30	M	M	0.35	45	26	21	17.3	13.0	10.4	8.7	6.4	5.2
	35	M	M	0.37	47	27	22	18.3	13.7	11.0	9.2	7.0	5.5
	40	M	M	0.40	51	30	24	19.8	14.9	11.9	9.9	7.4	5.9
	50	M	F	0.45	58	33	27	22	16.7	13.4	11.1	8.3	6.7
TP8005	30	C	M	0.43	55	32	26	21	16.0	12.8	10.6	8.5	6.4
	35	M	M	0.47	60	35	28	23	17.4	14.0	11.6	9.3	7.0
	40	M	M	0.50	64	37	30	25	18.6	14.9	12.4	9.9	7.4
	50	M	M	0.56	72	42	33	28	21	16.6	13.9	11.1	8.3
TP8006	30	C	M	0.52	67	39	31	26	19.3	15.4	12.9	10.3	7.7
	35	C	M	0.56	72	42	33	28	21	16.6	13.9	11.1	8.3
	40	C	M	0.60	77	45	36	30	22	17.8	14.9	11.9	8.9
	50	C	M	0.67	86	50	40	33	25	19.9	16.6	13.3	9.9
TP8008	30	C	C	0.69	88	51	41	34	26	20	17.1	13.7	10.2
	35	C	C	0.75	96	56	45	37	28	22	18.6	14.9	11.1
	40	C	C	0.80	102	59	48	40	30	24	19.8	15.8	11.9
	50	C	M	0.89	114	66	53	44	33	26	22	17.6	13.2
TP8008	60	C	M	0.98	125	73	58	49	36	29	24	19.4	14.6

There is more than one option to choose from, but this nozzle offers a broader range @ the speed he wishes to travel.

These calculations are based on a 20" spacing, refer to the Spray Products catalog for the formula for choosing a spacing other than 20".

# RAVEN SPRAY CONTROL CONSOLE

## NOTICE

**THIS IS JUST A GUIDE TO GET STARTED!** REFER TO THE RAVEN INSTALLATION MANUAL FOR MORE INFORMATION AND TROUBLE SHOOTING.

### Getting Started

1. The entry sequence is always the same. 1) depress the key in which you wish to enter data, 2) depress the ENTER key, 3) depress the keys corresponding to the number you wish to enter (the numbers will be displayed as they are entered), 4) complete the entry by again pressing the ENTER key.
2. When the console is initially turned on, it will flash CAL and display ACRES US. This means that the console must be calibrated or programmed before it can be operated. Once the console is calibrated or programmed, you will not have to do it again unless you wish to make changes. All data is retained if the console is turned off.
3. If any error is made during the programming of the area of measurement standard or the valve type, turn the console OFF. Depress CE and hold while turning the console power ON.

**IMPORTANT!** The information contained in this section is not meant to replace the information contained in the Raven's operational manual or the instructions of the chemical manufacturer. The information may need to be adjusted to suit the varying conditions under which the machine is being used. We can not account for the infinitely variable situations that may be unique to each machine, operator, and field/crop.

## NOTICE

**Data must be entered for keys 3 through 7.**



# RAVEN SPRAY CONTROL CONSOLE

## NOTICE

THIS IS JUST A GUIDE TO GET STARTED! REFER TO THE RAVEN INSTALLATION MANUAL FOR MORE INFORMATION AND TROUBLE SHOOTING.

Momentarily depressing the **CE** key is similar to using an arrow key to scroll through menu selections.

### Initial Contrast Adjustment



Use the  **1** key to lighten or the  **2**

key to darken the contrast.

Press the  **Enter** key when done.



### Acre-US, Hectare-SI or Turf- SQ Feet

Depress  **CE** until the unit of measure desired is displayed. Momentarily depress  **Enter** to select.



Continued on next page

# RAVEN SPRAY CONTROL CONSOLE

## NOTICE

THIS IS JUST A GUIDE TO GET STARTED! REFER TO THE RAVEN INSTALLATION MANUAL FOR MORE INFORMATION AND TROUBLE SHOOTING.

### Liquid, Gran 1, Gran 2, Gran 3

Depress **CE** until **LIQUID** is displayed.

Momentarily depress **Enter** to select.



### SDT Valve, Fast Valve, FST CLS Valve,

### PWM Valve, or PWM CLS Valve

Depress **CE** until **PWM VALVE** is displayed.

Momentarily depress **Enter** to select.



Continued on next page



# RAVEN SPRAY CONTROL CONSOLE

## NOTICE

**THIS IS JUST A GUIDE TO GET STARTED! REFER TO THE RAVEN INSTALLATION MANUAL FOR MORE INFORMATION AND TROUBLE SHOOTING.**

### Meter Cal, Spreader Constant

You will need to enter a **Meter Cal** for liquid applications. The meter cal is found on the flow meter in the main solution line.

Depress **Enter** to select. Enter this number using the 1-0 keys. Press **Enter** to end.



Continued on next page

# RAVEN SPRAY CONTROL CONSOLE

## NOTICE

**THIS IS JUST A GUIDE TO GET STARTED! REFER TO THE RAVEN INSTALLATION MANUAL FOR MORE INFORMATION AND TROUBLE SHOOTING.**

### Rate Cal

If you are applying multiple products, you must complete the following steps for each product. The active product will be highlighted.

Depress **Enter** to select.

Enter the number of gallons per acre (liters per hectare) that you wish to apply using the 1-0 number keys.

Depress **Enter** when finished.

This number is based on the preference of the operator, the condition of the field, and the product being applied. Read all chemical manufacturer's instructions before entering this parameter.

Pay attention to the placement of the decimal point! The decimal point can be shifted for greater accuracy, but if in the wrong place can cause great disaster.



Continued on next page

# RAVEN SPRAY CONTROL CONSOLE

## NOTICE

**THIS IS JUST A GUIDE TO GET STARTED! REFER TO THE RAVEN INSTALLATION MANUAL FOR MORE INFORMATION AND TROUBLE SHOOTING.**

### Wheel-SP1 or Radar- SP2

Depress **CE** until **RADAR-SP2** is displayed.

Momentarily depress **Enter** to select.

You will need to select **RADAR- SP2** on your Hagie sprayer. The sprayer is actually set up with a wheel drive speed sensor, but the pulse rate requires a radar setting.



Continued on next page

# RAVEN SPRAY CONTROL CONSOLE

## NOTICE

**THIS IS JUST A GUIDE TO GET STARTED! REFER TO THE RAVEN INSTALLATION MANUAL FOR MORE INFORMATION AND TROUBLE SHOOTING.**

### Speed Cal

The initial **SPEED CAL** is dependent on the size of tires installed on your machine. Below is a chart to get you started.

Depress **Enter** to select. Enter the number



using the 1-0 keys.



The speed cal may need to be refined after the initial programming of the console. Refer to the Raven manual for more information.

The speed that is displayed on the Raven console, if the console is programmed correctly and the speed cal is refined as necessary, should closely match the speed displayed on the MD3.

Depress **Enter** when finished.



### STS 14 RAVEN CALS

	380/85R46	520/85R46	580/70R38	320/90R50	320/105R54	380/90R54
<b>Bonfiglioli Hubs</b>	<b>320</b>	<b>358</b>	<b>320</b>	<b>324</b>	<b>358</b>	<b>358</b>



Continued on next page

# RAVEN SPRAY CONTROL CONSOLE

## NOTICE

**THIS IS JUST A GUIDE TO GET STARTED! REFER TO THE RAVEN INSTALLATION MANUAL FOR MORE INFORMATION AND TROUBLE SHOOTING.**

### Boom Cal

The  key and the  key will

allow you to scroll through the different boom numbers.



To determine the **Boom Cal** number, you will need to know how the boom is divided (the number of valves and which section they control), the spacing option installed, and the number of nozzles per section.

The diagrams on the following pages show a wet and a dry boom example.

The boom is numbered from left to right and that is your boom number. The number also corresponds with the spray section switches on the side console.

To get the boom cal number, multiply the number

Continued on next page

# RAVEN SPRAY CONTROL CONSOLE

## NOTICE

THIS IS JUST A GUIDE TO GET STARTED! REFER TO THE RAVEN INSTALLATION MANUAL FOR MORE INFORMATION AND TROUBLE SHOOTING.

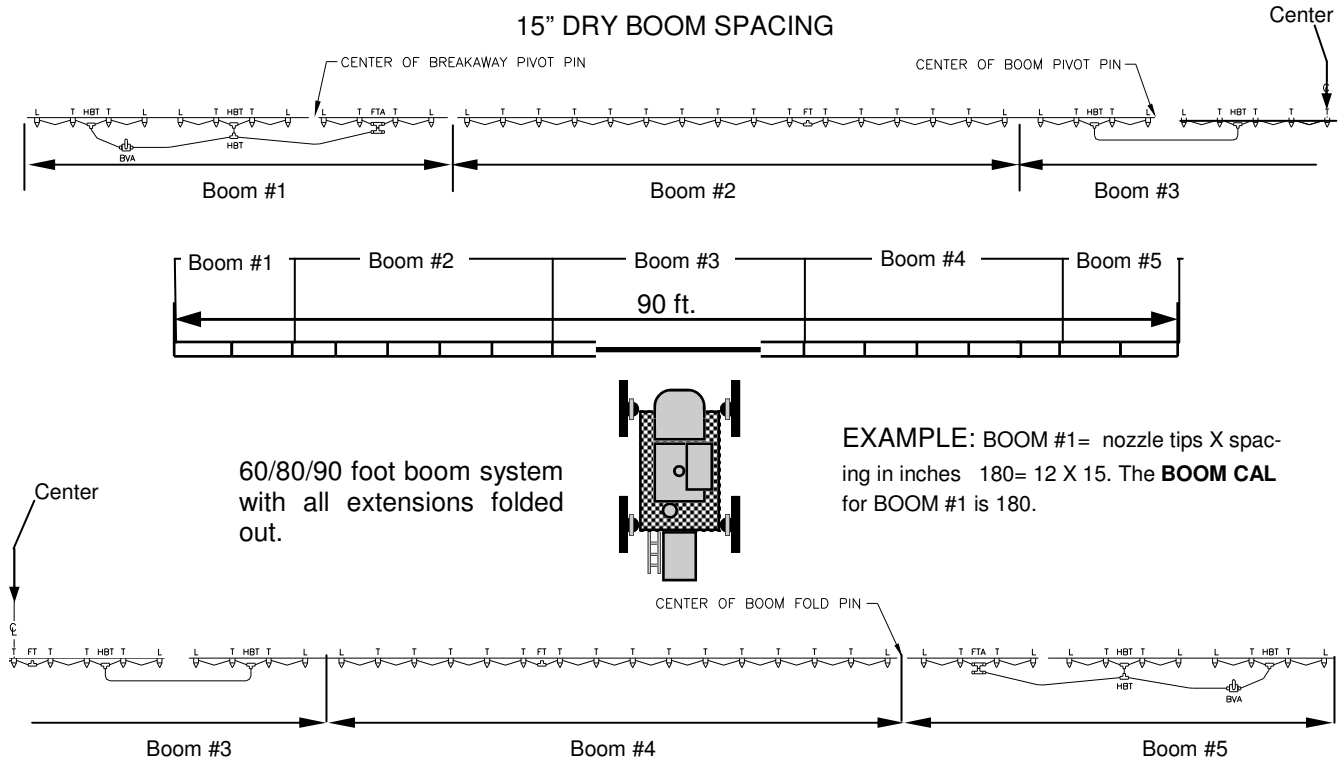

# RAVEN SPRAY CONTROL CONSOLE

## NOTICE

THIS IS JUST A GUIDE TO GET STARTED! REFER TO THE RAVEN INSTALLATION MANUAL FOR MORE INFORMATION AND TROUBLE SHOOTING.

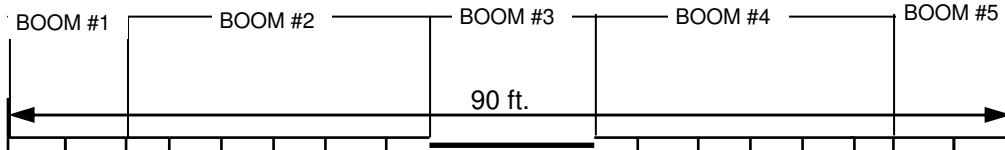

60/80/90 foot boom system with all extensions folded out.

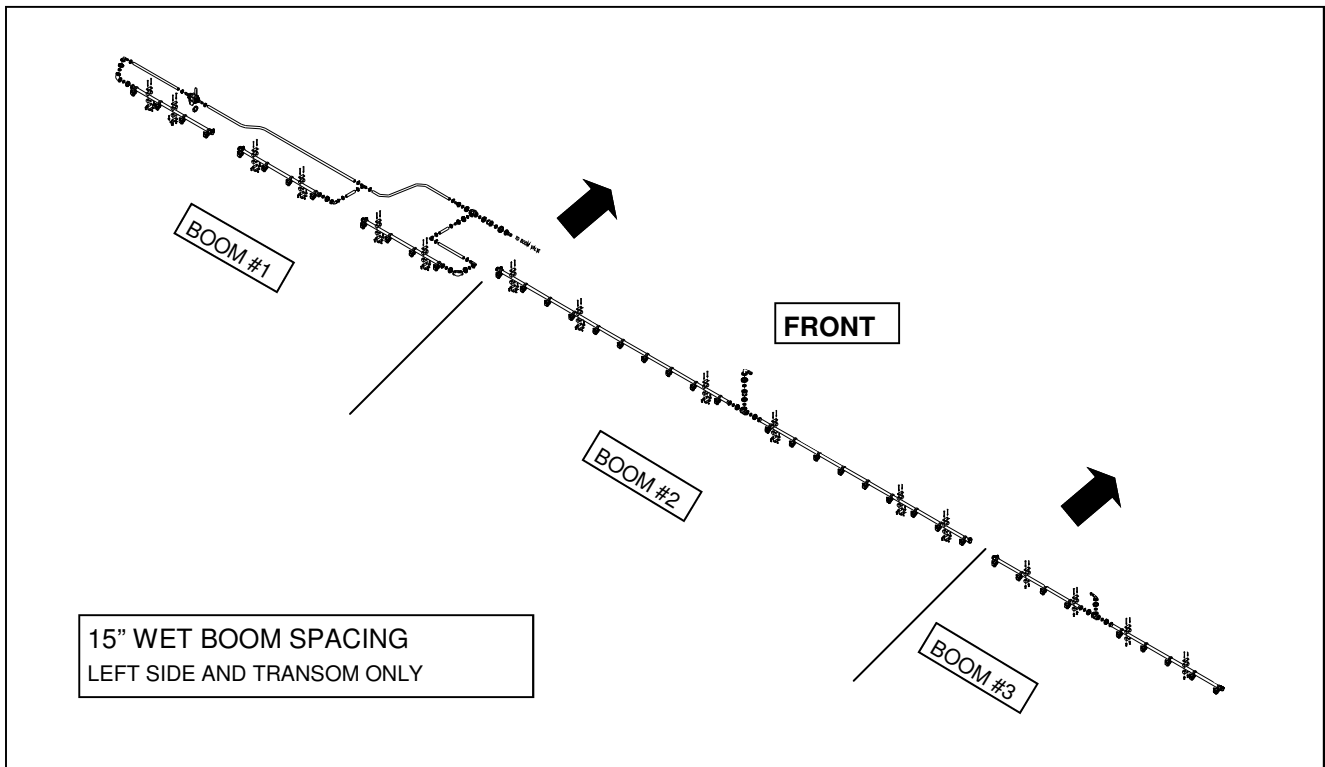
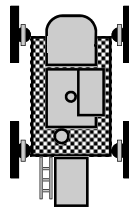

The difference between the dry boom (previous page) and the wet boom is that the dry boom's section 3 includes 4 nozzles on either side of the transom that are not included in the in the same section of a wet boom.

# RAVEN SPRAY CONTROL CONSOLE

## NOTICE

**THIS IS JUST A GUIDE TO GET STARTED! REFER TO THE RAVEN INSTALLATION MANUAL FOR MORE INFORMATION AND TROUBLE SHOOTING.**

To complete calibration you will need to enter some additional information.

### Product High Offset

Depress  to get to the data menu.

Press it again to scroll through the list on the left hand side of the screen. Stop when **PRODUCT** is highlighted.

Depress  until the **HIGH OFFSET** is highlighted.

Press  to select. Change this number to **170**. This indicates the fastest rate in which the solution valve will function.



Continued on next page



# RAVEN SPRAY CONTROL CONSOLE

## NOTICE

THIS IS JUST A GUIDE TO GET STARTED! REFER TO THE RAVEN INSTALLATION MANUAL FOR MORE INFORMATION AND TROUBLE SHOOTING.

### Product Low Offset

Depress  the until the **LOW OFFSET** is

highlighted.

Press  to select.

Change the number to **60**. This indicates the slowest rate in which the solution valve will function.



### Tank Volume

Depress the  to set the tank volume.

Depress  to select.

Enter the amount of solution in the tank.\*

Depress  to select.

\*This measure must be accurate. Re-enter every time you fill the tank.



The initial programming is now complete. You may have to refine some of the numbers to better suit your unique situation. This is just a guide to get you started, these numbers may not be specific to your machine. We can not account for every individual situation.

# RAVEN SPRAY CONTROL CONSOLE

## NOTICE

**THIS IS JUST A GUIDE TO GET STARTED! REFER TO THE RAVEN INSTALLATION MANUAL FOR MORE INFORMATION AND TROUBLE SHOOTING.**

## NOTICE

**DO NOT ADD CHEMICALS UNTIL CALIBRATION IS COMPLETE!**

### Verifying Calibration

To test your system, fill the solution tank with clean water. Do not add chemicals until calibration is complete!

1. Apply the brake.
2. Start the engine of the sprayer.
3. Throttle the engine to operating speed.
4. Turn on the Raven console.
5. Change the drive state of the sprayer to field state on the MD3.
6. Turn on the solution tank valve located on the right hand side console.
7. Turn on the main solution switch on the hydro-static lever.
8. Turn on all boom section solution switches on the side console.
9. Make sure there are no leaks and that all nozzles are spraying a desirable pattern.
10. Continue spraying in the stationary position for at least 10 minutes for proper warm up of the sprayer and its system.

Once the sprayer has had an adequate warm period, you will need to perform a "self test" to simulate speed although the machine will remain stationary. (see the next page on quick instruction for performing a "self test" ) Collect one nozzle's spray for one minute in an adequately sized and marked container.

Verify that the collection equals or is close to the gallons per minute for the nozzle, pressure, speed, gallons per acre, and spacing that you are using.

# RAVEN SPRAY CONTROL CONSOLE

## NOTICE

**THIS IS JUST A GUIDE TO GET STARTED! REFER TO THE RAVEN INSTALLATION MANUAL FOR MORE INFORMATION AND TROUBLE SHOOTING.**

### Performing a Self Test

Depress **SELF TEST 8** to start a self test.

Depress **Enter** to select.



Enter the speed that you wish to simulate using the 1-0 keys. Verify the speed in the lower corner of the display. The self test speed will clear itself when motion of the vehicle is detected. A speed cal value of 900 or greater is recommended when operating in this mode.

To verify accuracy, you will need to verify the flow meter. To do so, collect one nozzle's spray for one minute and multiply it by the number of nozzles on the booms. This should equal the amount measured through the flow meter.

To get the amount of fluid measured through the flow meter, depress **TOTAL VOLUME**. This will be your flow rate.

# RAVEN SPRAY CONTROL CONSOLE

## NOTICE

**THIS IS JUST A GUIDE TO GET STARTED! REFER TO THE RAVEN INSTALLATION MANUAL FOR MORE INFORMATION AND TROUBLE SHOOTING.**

### Changing the Valve Cal

Depress the **VALVE CAL 6** to enter the appropriate

**VALVE CAL** calibration number.

Depress **Enter** to select.

Enter the new calibration using the number keys.\*

Depress **Enter** when finished.

This number is indicative to the type of valve installed on the sprayer and its functions. This number may be refined within the PWM valve ranges. Refer to the Raven manual for more information on this number.



\*The **VALVE CAL** number is preprogrammed as 0043, but can be adjusted to suit your needs. Refer to the Raven manual for instructions.

# TRANSPORTING

## Cradling the Booms

The booms should always be cradled before traveling, transporting, or parking for an extended period of time. **The booms must be folded when cradled.**

To cradle the booms, fold the boom extensions in, raise the transom, and fold the booms in toward the machine. When the boom reaches the last 8-10 degrees of travel, it will automatically slow down to avoid impact with the cradle. Raise each individual boom level until it clears the outer cradle stop. Fold the boom in toward the cradle back-stop. When it touches the back-stop, lower the boom level until the full weight of the boom rests in the cradle (A).

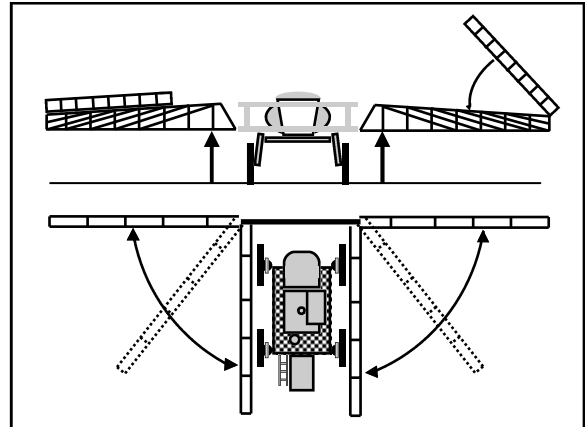

# TRANSPORTING

## Driving the Sprayer On A Public Road

When driving the sprayer on a public road or highway, drive carefully and follow these suggestions:

1. Always have the booms in the folded and cradled position when driving or transporting.
2. Use the flashing hazard/warning lights, day or night, unless prohibited by law, to warn other drivers.
3. Know and obey all state laws for driving farm equipment on a public road or highway.
4. Adjust the sprayer's speed to suit the conditions.
5. Slow down and use turn signals before turning.
6. Pull over to the side of the road before stopping.
7. Keep a proper lookout and maintain control of the sprayer.
8. Do not drive under tress, bridges, wires, or other obstructions unless there is proper clearance.
9. Use extra care before entering or leaving a public road or highway.
10. Make sure the SMV (Slow Moving Vehicle) emblem is properly displayed, unless prohibited by law, to warn other drivers.
11. Do not drive the sprayer at speeds exceeding 20mph with solution in the tank. Operating the machine fully loaded in excess of 20mph may result in tire blow out or wheel motor damage!



**Caution:** Hagie Manufacturing Company does not recommend any form of transportation other than driving the sprayer. Loading the sprayer onto a trailer may result in sprayer rollover.

# TRANSPORTING

## Loading

When moving the sprayer onto a trailer, follow these steps completely:

1. Pull the trailer to flat ground. Apply the pulling vehicle's parking brakes and turn off the engine. Use tire chocks to keep the trailer from moving.
2. Fold the sprayer's booms and lower into the cradles.
3. Lower the trailer ramps and set the ramp spacing for the tread width setting.
4. Get someone to help guide you onto the trailer. Keep everyone a safe distance from the trailer.
5. Allow enough room between the sprayer and the pulling vehicle for turning.
6. Secure the sprayer to the trailer. See the trailer's owner and operation manual for instructions. Cover or remove the SMV (Slow Moving Vehicle) emblem when traveling over 25 miles per hour.





## NOTICE

Be sure to read and understand the trailer's owner and operator manual. Hitch the trailer to the pulling vehicle as shown in the trailer's owner manual.

## NOTICE

The loaded height and width of the trailer must conform to the law of the state in which it is being used. Do not exceed trailer manufacturer's recommendations on loaded weight.

 **Warning:** Never load or unload a sprayer with solution in the tanks!

 **Warning:** Stopping the sprayer on the trailer ramps may result in sprayer tip over!

 **Caution:** Hagie Manufacturing Company does not recommend any form of transportation other than driving the sprayer. Loading the sprayer onto a trailer may result in sprayer rollover.

# TRANSPORTING

## Unloading

When moving the sprayer off of a trailer, follow these steps completely:

1. Pull the trailer to flat ground. Apply the pulling vehicle's parking brakes and turn off the engine. Use tire chocks to keep the trailer from moving.
2. Lower the trailer ramps and set the ramp spacing for the tread width setting.
3. Release the securing restraints carefully.
4. Get someone to help guide you off of the trailer. Keep everyone a safe distance from the trailer.
5. Uncover or replace the SMV emblem.



## NOTICE

The STS model sprayer should never be towed under any circumstances.\* Machine damage will occur and void the power train warranty.

 **Warning:** Never load or unload a sprayer with solution in the tanks!

 **Warning:** Stopping the sprayer on the trailer ramps may result in sprayer tip over!

\* Contact Hagie Customer Support if towing is unavoidable.

 **Caution:** Hagie Manufacturing Company does not recommend any form of transportation other than driving the sprayer. Loading the sprayer onto a trailer may result in sprayer rollover.



# SERVICE INTERVALS

Page	Service Point	Initial	Daily	As Req	50 hrs	
105-1	Check lug nut torque	•				
80-1	Check engine oil level		•			
80-3	Check radiator coolant level		•			
85-2	Check radiator grille screen		•			
100-1	Check engine drive belt		•			
100-2	Check air compressor belt		•			
85-2	Check Filter Minder® level		•			
80-1	Check hydraulic reservoir level		•			
85-5	Check solution line strainer		•			
95-1	Check batteries		•			
75-3	Check for leaks around the sprayer		•			
85-4	Check and drain fuel filter (water separator)		•			
115-1	Drain wet tank/air tank		•			
80-5	Check windshield washer fluid level		•			
85-3	Check hydraulic fill screen			•		
115-3	Replace windshield wiper blades			•		
80-5	Fill windshield washer fluid			•		
85-2	Clean radiator grille screen			•		
80-4	Change coolant concentration			•		
100-1	Change engine drive belt			•		
100-2	Change A/C compressor belt			•		
80-5	Charge A/C compressor*			•		
85-4	Change fuel filter (water separator)			•		
85-4	Change remote fuel filter			•		
85-1	Change air intake filter (Filter Minder®)			•		
85-5	Change solution line strainer			•		
105-2	Change tread adjustment bearing torque			•		
95-1	Change batteries			•		
85-6	Change fresh air (paper) cab filter			•		
85-6	Change charcoal cab filter			•		
115-3	Change spray nozzle diaphragms and tips			•		
95-2	Change or replace fuses and breakers			•		
85-5	Change rinse strainer			•		
105-1	Check lug nut torque				•	
80-2	Change wheel hub oil (50 hrs break-in period)				•	
85-3	Change hydraulic return/suction filter (break-in)				•	

Filter Minder® is a registered trademark of Engineered Products Company

\* use proper equipment

\*\* 500 hours or yearly whichever comes first.

# SERVICE INTERVALS

Page	Service Point	50 hrs	100 hrs	250 hrs	500 hrs**	1000 hrs
115-2	Check tire pressure	•				
105-2	Visually inspect tread adjust bearing bolts	•				
90-1	Grease all leg lubrication zerks	•				
90-1	Grease ladder lubrication zerk	•				
90-2	Grease transom pivot tube (boom) lubrication zerks	•				
85-1	Knock all particles from fresh air intake cab filter	•				
115-1	Check air dryer cartridge	•				
80-2	Change wheel hub oil (break-in period)		•			
80-2	Check wheel hub oil		•			
95-1	Clean batteries		•			
105-2	Check tread adjust bearing bolt torque		•			
100-2	Check air compressor belt			•		
85-3	Change hydraulic return/suction filters			•		
80-3	Check coolant concentration				•	
85-4	Change fuel filter				•	
80-1	Change hydraulic reservoir oil				•	
80-2	Change wheel hub oil				•	
115-3	Check spray nozzle diaphragms and tips				•	
80-1	Change engine oil				•	
85-4	Change in-line fuel strainer				•	
85-4	Change remote fuel filter				•	
85-3	Change engine oil filter				•	
85-3	Change hydraulic return/suction filters				•	
80-4	Change radiator coolant					•
115-1	Change air dryer cartridge					•
115-3	Change spray nozzles and tips					•
	Call Cummins for exhaust brake service					•

\*\* 500 hours or yearly whichever comes first.

# SERVICE INTERVALS

Inspection Point	Action (if necessary)
<b>Check</b>	
Engine oil level	Add oil
Radiator coolant level	Add antifreeze solution
Engine drive belt	Replace belt
Filter Minder®	Replace air filter element/reset gauge
Hydraulic reservoir oil level	Add hydraulic oil
Solution line strainer	Remove and clean
Batteries	Clean and/or tighten
Radiator grille screen	Clean
Look for loose or missing items such as shields	Tighten or replace
Look for any fluid leaks on machine or ground	Determine cause and correct
<b>Drain</b>	
Fuel/water separator	See page 85-4
Wet tank/air tank	See page 115-2

# SERVICE: FLUIDS

## Engine Oil

**Oil level**– The engine oil level dipstick is located on the left-hand side of the engine. Never operate the engine with the oil level below the “L” (low) mark or above the “H” (high) mark. Wait at least five minutes after shutting the engine to check the oil level, this allows the oil to drain to the oil pan. Check the engine oil level daily.

**Capacity**– Low to high mark capacity is 2.0 quarts. The engine oil pan capacity is 17 quarts. Change the engine oil every 500 hours or yearly. Refill with 15W40 diesel engine oil.

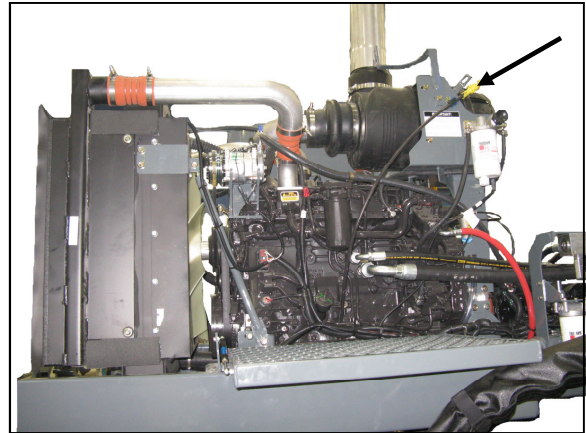

## NOTICE

The engine must be level when checking the oil level to make sure the measurement is correct.

## Hydraulic Oil Reservoir

**Oil level**– Check the sight gauge level on the hydraulic oil reservoir daily. Add just enough fluid so the level is in the center of the sight gauge. Always check the hydraulic oil level when it is cool. Hydraulic will expand when heated.

**Type**– Premium hydraulic fluids containing high quality rust/oxidation/ and foam inhibitors are required. Hydraulic oil must conform to one of the following types: anti-wear hydraulic oil, type F automatic transmission fluid, or agricultural hydraulic transmission fluid. Replace the oil in the hydraulic reservoir at 500 hours or at the beginning of each spraying season, whichever comes first.



## NOTICE

Cleanliness Standard: Always make sure area is clean before changing filter or hydraulic oil.

# SERVICE: FLUIDS

## Wheel Hub Oil

**Bonfiglioli: Oil level**– Each wheel hub should maintain a proper oil level at all times. Less than that would limit lubrication and over full would cause overheating and damage. To check the oil level, position the hub so one of the face plugs is positioned at 12 O'clock (A). The other plug will be at 8 O'clock (B). (When positioned correctly the arrows in the center of the hub should make an “L”) Remove the lower plug, if no oil comes out, the oil level is too low. Check the hub oil level every 100 hours.

If SAE 80W/90 or SAE 85W/140 with EP features oil is needed, remove the top plug also and fill just until it starts to come out the lower hole (approximately 40 ounces). With the oil at a satisfactory level, re-install plugs.

**Change**-The wheel hub oil should be changed after the first 50 hours of field operation. Subsequently, it should be changed every 500 hours or yearly (whichever comes first).

To change the wheel hub oil, position the plugs so that one is at the 6 O'clock position and the other is between the 2 and 3 O'clock positions. Remove the bottom plug to drain the oil. Once all of the oil is drained, rotate the hub so that the plugs are in the filling position. Refill wheel hub with gear oil as described above.

**General Maintenance**– If your sprayer is going to sit for an extended period of time, occasionally rotate the hubs by driving the sprayer forward and backward at least 1/2 of a tire rotation to adequately coat all internal hub parts. This will prevent rusting if moisture inadvertently entered the hub during an oil change.

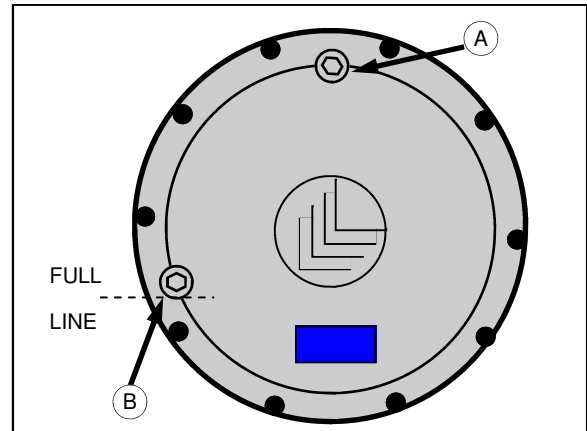

## NOTICE

Failure to rotate the hub and disperse oil may cause rusting and internal damage to the hub.

# SERVICE: FLUIDS

## Cooling System

**Coolant type**— Your cooling system should always be sufficiently charged with an adequate mixture of antifreeze and water, regardless of the climate, in order to maintain a broad operating temperature range. Your cooling system has been factory charged with an ethylene-glycol based antifreeze.

**Checking Concentration**— The radiator cap is located toward the rear of the engine compartment (A). Never remove the cap from a hot engine. Always allow the engine to cool before servicing the cooling system.

A 50/50 antifreeze water mixture is a conservative mixture which allows good protection against both overheating and freezing. If a stronger antifreeze mixture is required, be sure not to exceed the engine manufacturer's guidelines for antifreeze mixing. The table (B) gives a few examples of ethylene-glycol antifreeze/water mixture protection values. Consult the engine manufacturer's handbook for further information.

Concentration should be checked every 500 hours or at the beginning of a spray season whichever comes first. A refractometer should be used to check concentration, "floating ball" type density testers are not accurate enough for use with heavy duty diesel cooling system.



Ethylene Glycol	
40%	-23°C -10°F
50%	-37°C -34°F
60%	-54°C -65°F

continued on next page

# SERVICE: FLUIDS

**Changing coolant**— Your coolant should be changed periodically to eliminate the buildup of harmful chemicals. Drain and replace the coolant every other spraying season or 1,000 hours of service, whichever comes first. Refill only with soft water because hard water contains minerals which break down the anti-corrosion properties of antifreeze.

## Fuel

**Type**— No. 2 diesel fuel is recommended for the best economy and performance under most operating conditions. In operating conditions under 32°F, use a blend of No.1 and No. 2 diesel fuel. The addition of No.1 diesel fuel may cause loss of power and/or fuel economy.

**Storing**— See the section on storing the machine.

**Refueling**— Always turn off the engine and allow it to cool before refueling. Never smoke while fueling. Keep a fire extinguisher within reach while refueling.

The fuel cell on a STS holds 150 gallons— do not fill it completely, fuel can expand and run over. Wipe up all spilled fuel and clean with detergent and water before starting the engine.

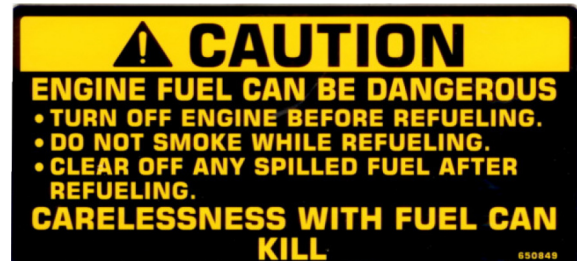

# SERVICE: FLUIDS

## Windshield Washer Fluid

**Reservoir**– The windshield washer reservoir is located on the rear of the cab. check it occasionally and refill it with non-freezing automotive windshield cleaner as required.



## Air Conditioning

**Type**– The cab on the sprayer is equipped with a R-134a air conditioning system.

**Recharging**–Recharge it only with R-134a refrigerant. If your air conditioning system is mistakenly charged with R-12 refrigerant, serious problems, such as compressor seizure, may result. Therefore, confirm refrigerant before recharging the system.

If you do not have the proper equipment, it is recommended that you allow an independent service agent service your air conditioning system.

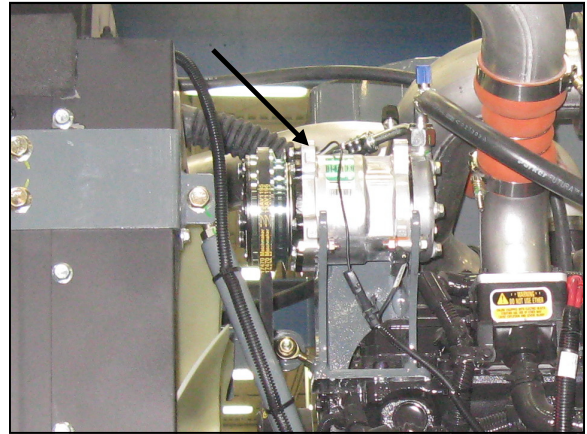

### FLUID CAPACITIES AND TYPES

Engine oil pan, including filter.....	17 quarts
	SAE 15W-40
Engine oil dipstick, L-H mark.....	2 quarts
Hydraulic oil reservoir .....	32 gallons
	anti-wear
	hydraulic oil
Hydraulic system (reservoir, lines, filter, cooler, etc) .....	55 gallons
Wheel hub oil level	
Bonfiglioli wheel hub (4) .....	approx. 40 oz. ea
Engine cooling system.....	18 gallons
	ethylene glycol
Fuel cell.....	150 gallons
	No. 1 or 2 diesel



# SERVICE: FILTERS

## Engine Air Intake

**Location**– The engine air intake filter is accessed by opening the door on the front of the engine compartment (A).

**Removal**– The engine air intake filter element should only be removed if it is going to be replaced. After loosening the air cleaner and removing the end cap, carefully remove the filter so as not to knock any dust off the filter and into the air intake passage (B). The secondary filter does not need to be replaced if the primary is intact.

**Replacement**– Your sprayer is equipped with a Filter Minder® to notify you of filter element efficiency. Follow its guidelines for servicing (see next page). At appropriate service time, install the new element carefully to ensure proper sealing.

**Cleaning**– It is not recommended to clean the air intake filter element. However, a clean damp cloth should be used to wipe away dust and foreign material from the air cleaner housing.

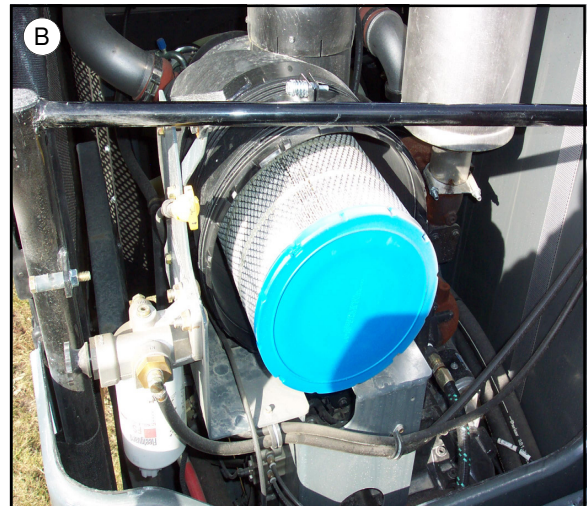
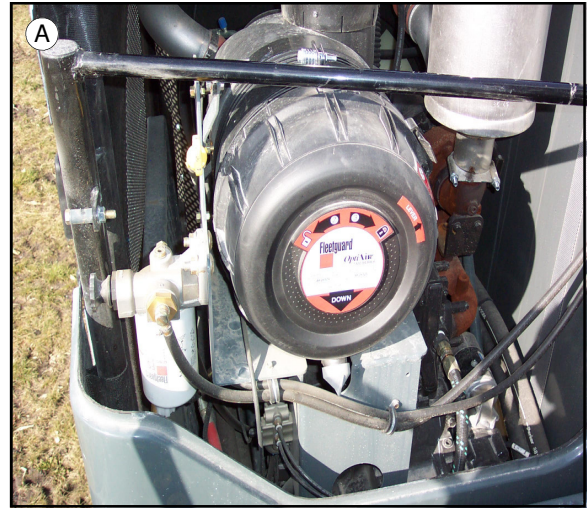

## NOTICE

Do not tap to remove dust. Engine damage may occur due to crushed filter caused by tapping. If the Filter Minder® indicates restriction, remove old filter, discard and install new filter only.

# SERVICE: FILTERS

## Filter Minder®

**Location**– The Filter Minder® is an air restriction monitoring system that progressively and constantly indicates how much air filter capacity remains. It is mounted on the foam marking tank mount bracket. Check its reading daily.

**Service**– Service the air cleaner when the Filter Minder® reads 20" (80% of dirt holding capacity). Service the air cleaner before the yellow indicator reaches the red line of the Filter Minder®. Be sure to reset the system after servicing.



## Radiator Screen

In order to maintain air flow through the engine cooling system's radiator, oil cooler, and air conditioning condenser, the cooling air intake grille must be inspected often and periodically cleaned.

When the engine hood has been opened for servicing, use compressed air to dislodge most large trash and dirt. Blow out the screen AWAY from the machine. Water from a pressurized hose may also be used, or if necessary the screen may be soaked with soapy water and scrubbed gently with a brush.

When cleaning the cooling fins of the radiator, oil cleaner, or A/C condenser with compressed air or water, be careful not to damage the cooling fins which may impair cooling capabilities.

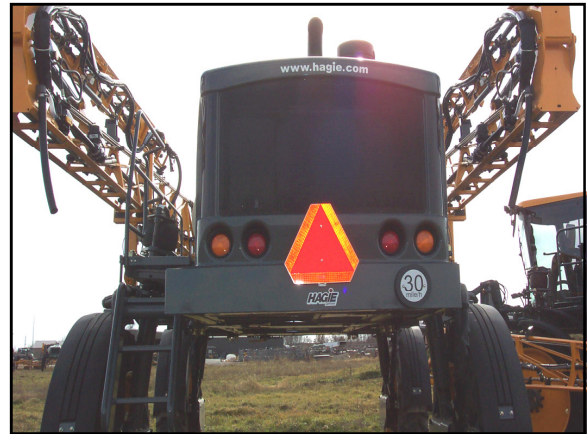

## NOTICE

Failure to keep cooling systems clean can cause overheating and damage to the hydrostatic system and/or engine.

# SERVICE: FILTERS

## Hydraulic Filter and Strainers-

**Return Filter-** Remove and install a new 10 micron rated return filter at the end of the first 50 hours of use, subsequently replace the filter every 250 hours, or once a year, whichever comes first.

**Suction Strainers-** The suction strainers located inside of the tank should be examined for wear and blockage when the tank is empty for fluid service.

**Fill Screen-** Replace the fill screen immediately if there are any signs of a tear or break. The screen is the first defense against foreign materials entering the tank.



## Engine Lube Filter

The engine lube filter (oil filter) should be changed every 500 hours or anytime that the oil is changed.

The filter is located under the service platform, behind the right rear wheel. It is accessible from the ground level.



# SERVICE: FILTERS

## Fuel Filters and Strainers

**Remote Fuel Filter-** (A) Located near the air intake filter, this filter should be replaced every 500 hours or once a year, whichever comes first.

**Primary Fuel Filter (Water Separator)-** (C) Located on the right side of the engine, this filter should be drained daily of water and other deposits. Replace the filter every 500 hours or as necessary.



# SERVICE: FILTERS

## Other Strainers

**Poly Rinse Tank Strainer**– If you have the pressure washer option on your sprayer you will have a 100 mesh strainer in the line from the rinse tank to the pressure washer (refer to Hagie Parts Manual for location). Check the strainer for blockage if you are unable to get pressure.

**Rinse Strainer**– The poly tanks have a 150 PSI (32 mesh) strainer in the line from the rinse valve to the solution tank rinse. If you are experiencing issues with pressure through your rinse cycle, you may check this strainer.

**Solution Line “Y” Strainer**– To help maintain consistent application rates, check the solution line strainer (A) daily for blockage. Clean the strainer screen as required. Be sure to wear appropriate clothing while removing and cleaning the line strainer screen. Confirm the gasket is in place before re-installing the screen.

**Check all strainers occasionally for blockage and replace them if they show signs of deterioration. Refer to the Hagie Parts Manual for replacement part numbers and specific locations.**



# SERVICE: FILTERS

## Fresh Air Cab Filters

**Paper Filter**– The paper filter should be cleaned every 50 hours, or more often if necessary. Remove the paper element and gently tap it against a flat surface. Direct low pressure compressed air through the filter to remove larger particles. Replace the paper filter if necessary.

**Charcoal Filter**– Remove and replace the charcoal filter at the first signs of chemical odor entering the cab.

To remove, clean, or replace the filters in the cab, undo the thumb screws on the cover (A) behind the operator's seat and carefully remove the filters. Wipe the cover clean with a damp cloth and allow to dry before replacing.

Figure B shows the air tube that allows fresh air into the cab. Check it often for any material blocking the opening.

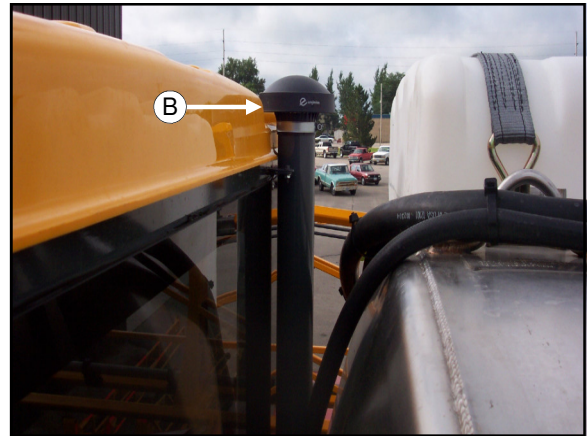
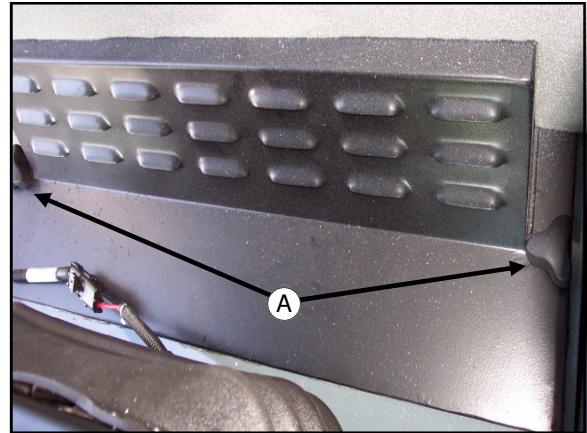

# SERVICE: LUBRICATION

## Legs and Steering

The front legs have a grease zerk in the tie rod ball (A) that needs greased every 50 hours or weekly.

Both the front and rear legs have two grease zerks, one in each of the tower bearings (B) that must be greased every 50 hours or as necessary. There is a grease zerk in the collar (C) under the air bag mounting plate that needs greased every 50 hours also. Do not use air-type grease gun to lube leg towers as this may result in seal distortion.

The slide path of the tread adjust (D) should be greased every 50 hours depending on the amount of usage.

Each leg also has two grease zerks on the outside of the leg tube that should be greased every 50 hours. Tall crops may wipe away much of the grease, be sure to check each leg daily.

If AWS has been installed on your machine, the steering cylinders on the rear legs will also have the grease zerks in the tie rod ends. ▲

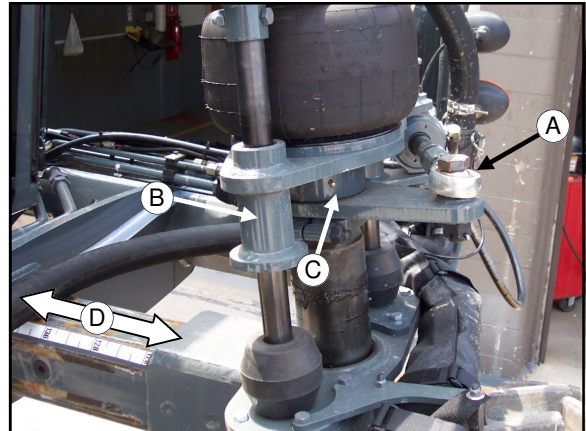

## NOTICE

**Failure to properly lube pivot and friction points may result in unnecessary wear and damage.**

## Ladder

The ladder pivot tube has a grease zerk that needs to be lubed every 50 hours or as needed.

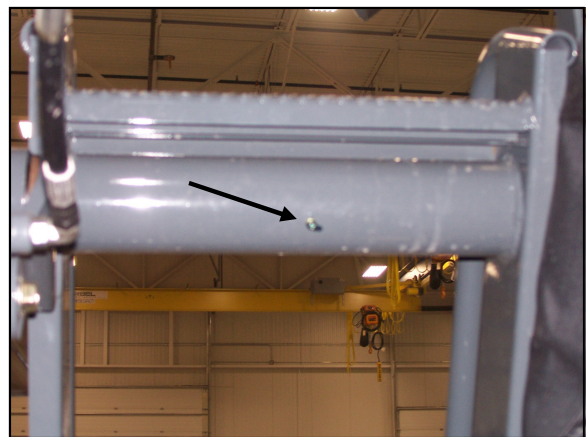

# SERVICE: LUBRICATION

## Transom Pivot Tubes

The transom pivot tube that attaches the booms to the transom has a grease zerk that should be greased every 50 hours or as needed depending on the amount of use. There is one on each side.

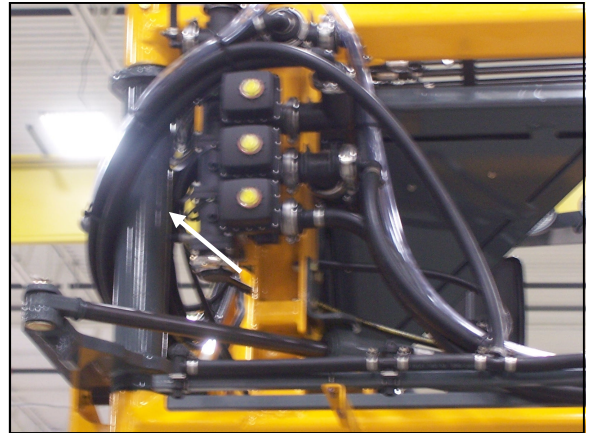



# SERVICE: ELECTRICAL SYSTEM

## Batteries

**Service Access**— The batteries are located at the rear of the machine behind the battery service access panel (A). When servicing the electrical system, always remove the batteries. Remove the ground cable first and connect it last.

**Cleaning**— Disconnect the battery cables from the batteries. Remove the corrosion with a wire brush or battery post brush. Wash the cable connections and battery posts with a weak solution of baking soda and ammonia. Apply dielectric grease or grease to prevent further corrosion. Reconnect the batteries making sure that they are tight. Clean every 100 hours.

**Charging**— To ease charging of the batteries, there is a set of auxiliary battery charging posts on the rear of the sprayer's mainframe (B). Connect your charging cables to them just as you would to the battery, positive cable to the positive terminal, and negative cable to the negative terminal. Keep these terminals clean and their caps in place when not in use.

 **Caution:** Batteries contain sulfuric acid. Avoid contact with skin, eyes, or clothing. Do not inhale fumes or ingest liquid. Batteries contain gases which can explode. Keep sparks and flame away while servicing.

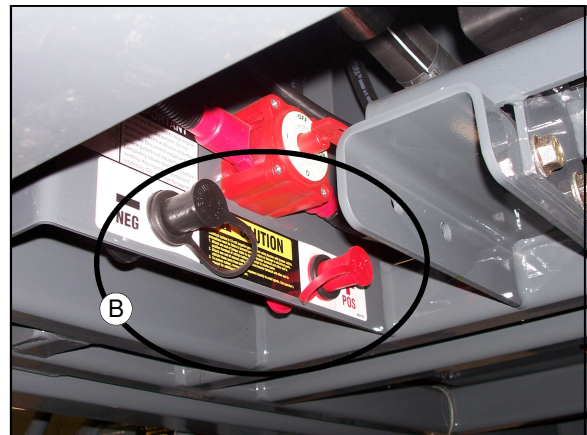
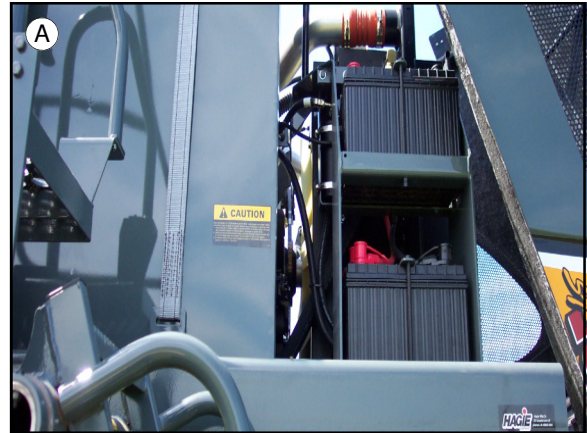

## NOTICE

To ensure the best electrical contact, battery terminal connections should be as clean and as tight as possible.

Install replacement batteries with ratings equivalent to the specs below.

**VOLTAGE** ..... 12 V (only)

**CCA (30 sec. at 0 ° F)**..... 950

**RESERVE CAPACITY** ..... 185 min.  
at 25 amps

# SERVICE: ELECTRICAL SYSTEM

## Circuit Breakers & Fuses

The STS has a circuit breaker and fuse systems in various locations. Under the right hand console (A) for the cab functions, under the cab (B) for the light functions, and the engine compartment (C) for the engine functions.

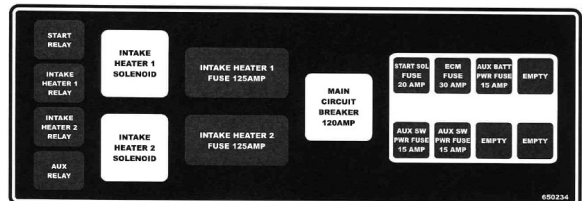
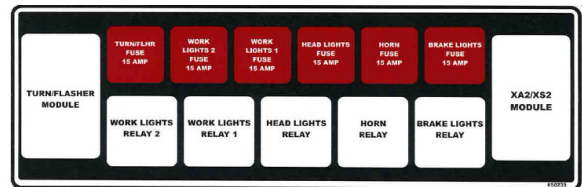
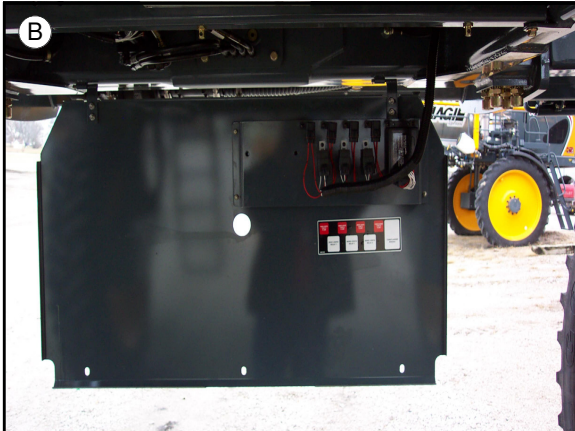
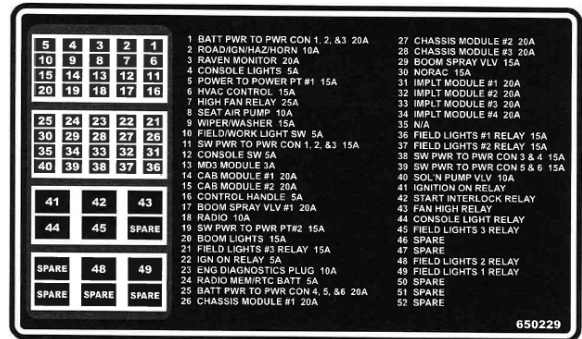

# SERVICE: BELTS

## Engine Drive Belt

**Removal**– Insert a 1/2 inch square ratchet drive into the belt tensioner (A) and lift upward to remove the belt (B).

**Inspection**– Visually inspect the belt daily. Check the belt for intersecting cracks (C). Transverse (across the belt width) cracks are acceptable. Longitudinal (direction of the belt length) cracks that intersect with transverse cracks are not acceptable. Replace the belt if it is frayed or has pieces of material missing.

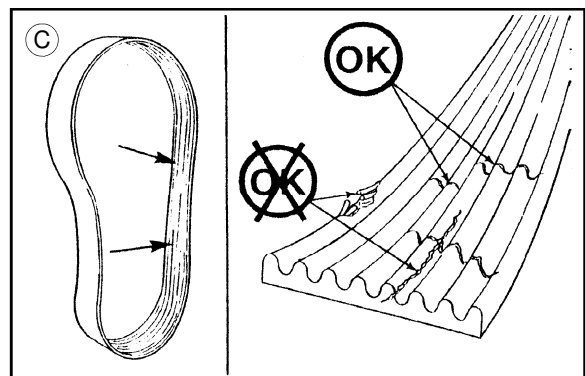
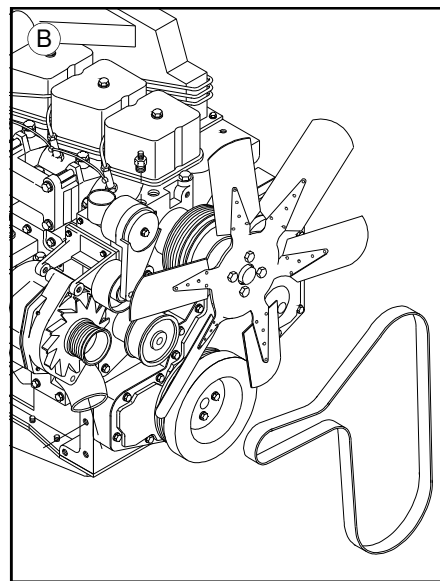
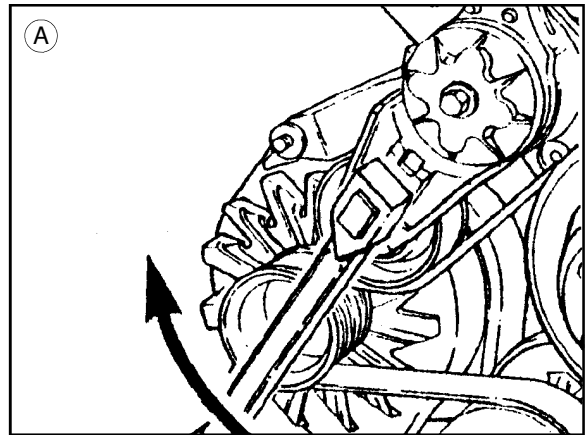

# SERVICE: BELTS

## A/C Compressor Belt

To tighten air conditioner compressor belt loosen the pivot bolt (A) just enough to allow movement. Then loosen the adjustment bolt (B). Using a prying tool, adjust the tension of the belt to the desired tautness. While maintaining tension, re-tighten the bolts.

Visually inspect the belt daily. Replace the belt if it is frayed or missing material.

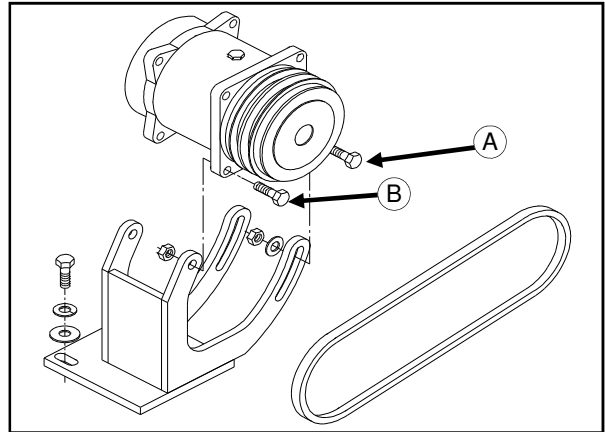

# SERVICE: BOLT TORQUE

## Wheel Bolts

If you do not have the proper equipment to mount a tire, let your local qualified tire sales/service dealer mount the tire for you. The tire should be mounted on the rim according to figure A for best traction and tread cleaning action. To install wheel and tire assembly on the wheel hub, lubricate the studs with an anti-seize grease. Align the wheel bolt holes with the wheel hub studs and mount the wheel on the hub.

Start all of the lug nuts and tighten them until they are just snug. Following the torque sequence shown in figure B, first turn each lug nut to a torque value of 120 dry foot pounds. Use slow, even pressure on the torque wrench. Quick or jerky movements cause inaccurate values. Repeat the same sequences to 150 dry foot pounds and again finally to 400 to 500 dry foot pounds.

If the wheel turns during lug nut torquing, lower the machine to the ground just enough for the tire to touch and prevent rotation, or more preferably, place a suitable wedge between the tire and the ground. Lower the machine and resume operation. Recheck torque after 30 minute of operation.

**!** **Caution:** Check lug nut torque immediately after receiving the machine and every 50 hours thereafter.

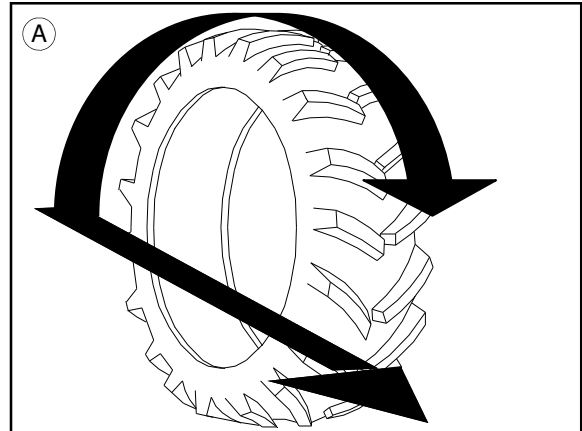

**Keep wheel bolts tight.  
See owner's manual for  
torque specifications.**

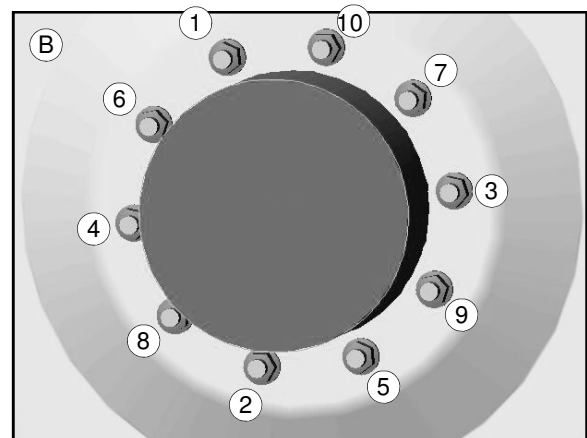
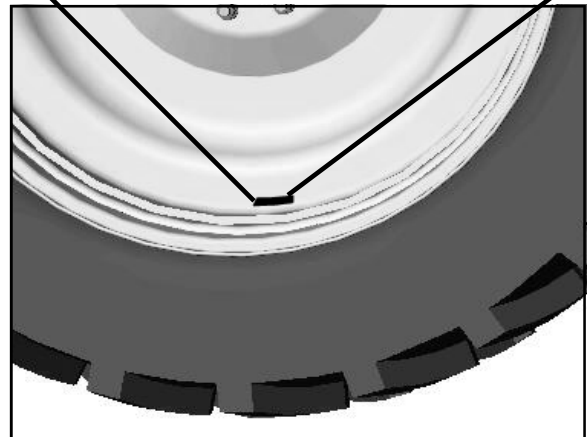

# SERVICE: BOLT TORQUE

## Hydraulic Tread Adjust Units

With the engine turned off, visually inspect the tread bearing bolts on both the bottom and side tread adjust bearing plates every 50 hours. Torque check them every 100 hours.

To torque check the tread adjust bearing bolts:

1. Loosen the jam nut (A) on each tread adjust bearing bolt.
2. Using an "X" pattern (B), verify that current torque on each tread adjust bearing bolt is equivalent to the last check from 100 hours previous.
3. Repeat pattern 3 to 4 times until last sequence shows no movement of the bolts to achieve desired torque.
4. Tighten jam nut.

Typically a torque value of 20 to 25 foot pounds is required to stabilize the axle and still allow tread width adjustment.

Never operate the unit with loose or missing tread adjust bolts.

continued on next page

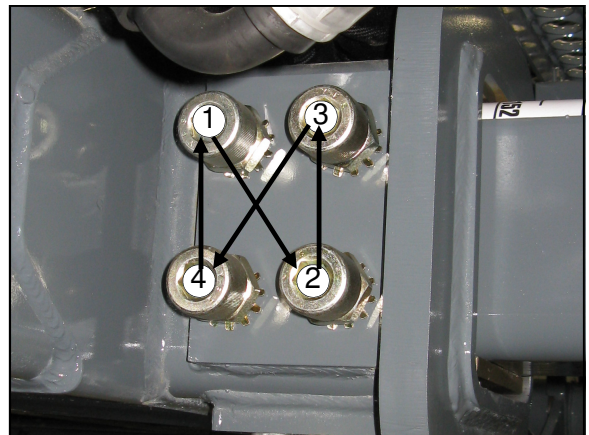
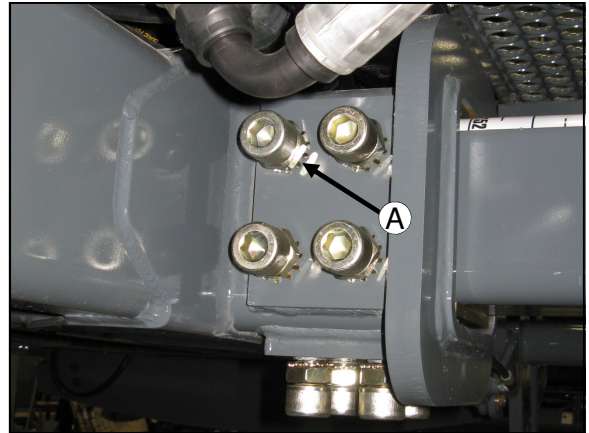

## NOTICE

If hydraulic tread adjust will never be used on your machine or you do not have hydraulic tread adjust, set all bolt torque settings to 50 foot pounds using the same procedure as stated at the left.

# SERVICE: BOLT TORQUE

## Hydraulic Tread Adjust Units

### Even pressure of the tread adjust bearing

plates is required for proper operation! Figure A shows the correct position of the tread adjust bearing plates and bolts as well as the outer leg. Figure B shows the plates when there is not even torque on each of the tread adjust bearing bolts. Figure C shows a situation in which there is not enough torque on the tread adjust bearing bolts. Both figure B and C will cause the tread adjust to operate incorrectly or not at all.

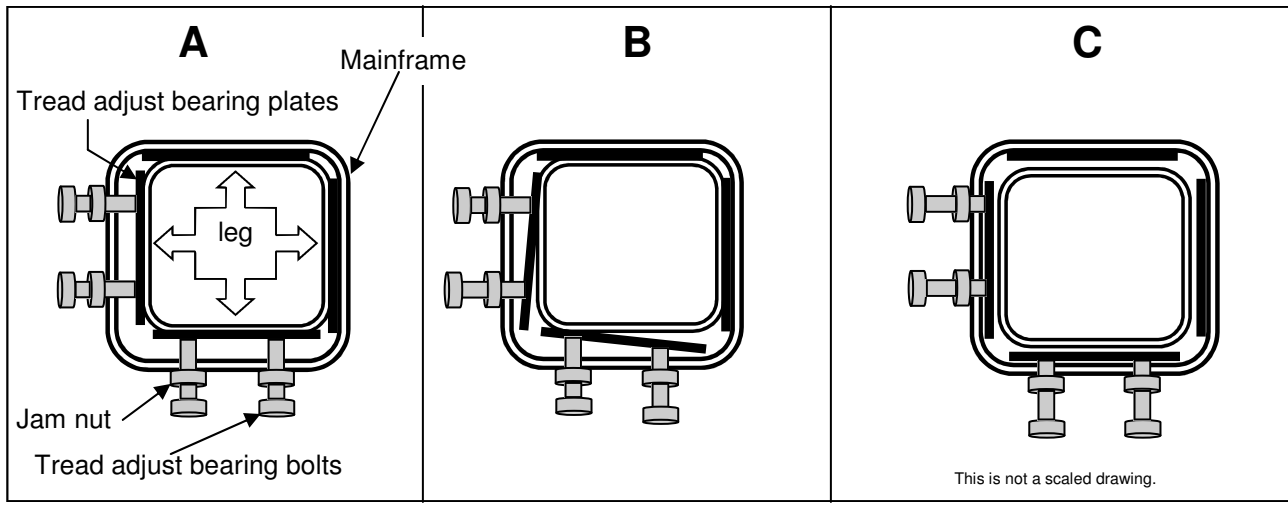

# SERVICE: TOE-IN

## Gauging Toe-In\*

To correctly gauge toe-in, phase the cylinders first (page 40-7). Then use a tape measure to measure the wheel from the ground to the center of the wheel hub. Mark that distance on both the front and rear rim lip of all four tires (A). The measurement should be the same on all four tires.

Using the lines drawn on the tires, measure from the front rim lip of the left front tire to the rear rim lip of the right front tire (B, 1-d). Then measure from the front rim lip of the right front tire to the rear rim lip of the left front tire (B, 1-c). These measurements should be the same and will verify that the wheels are straight ahead. If the measurements are not the same, make small corrections to the steering until they are.

To gauge toe-in, again using the marks on the rims, measure from the right rear mark on the front

tire to the left rear rim lip on the front tire (B, 1-b).

Measure from the right front rim lip to the left front rim lip on the front tire (B, 1-a). Subtract the value of 1-a from the value of 1-b. The result should be between  $\frac{1}{2}$  and  $\frac{3}{4}$  inches (front wheels only).

Repeat the process on the rear wheels. The measurements should be the same resulting in zero toe-in.

Toe-in is preset at the factory and should not have to be adjusted unless the steering cylinders are removed. Difficulty steering one way versus the other or "darting" during operation, may indicate incorrect toe-in and may require adjustment.

\* Toe-in procedures are intended for conventional steering machines only. Customers with AWS will need to contact Hagie Customer Service for toe-in information.▲

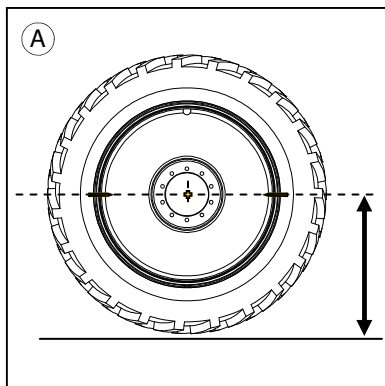

**NOTICE**  
See the next page for instructions on adjusting toe-in. See also page 40-7 for information on recalibrating (phasing) self-centering cylinders.

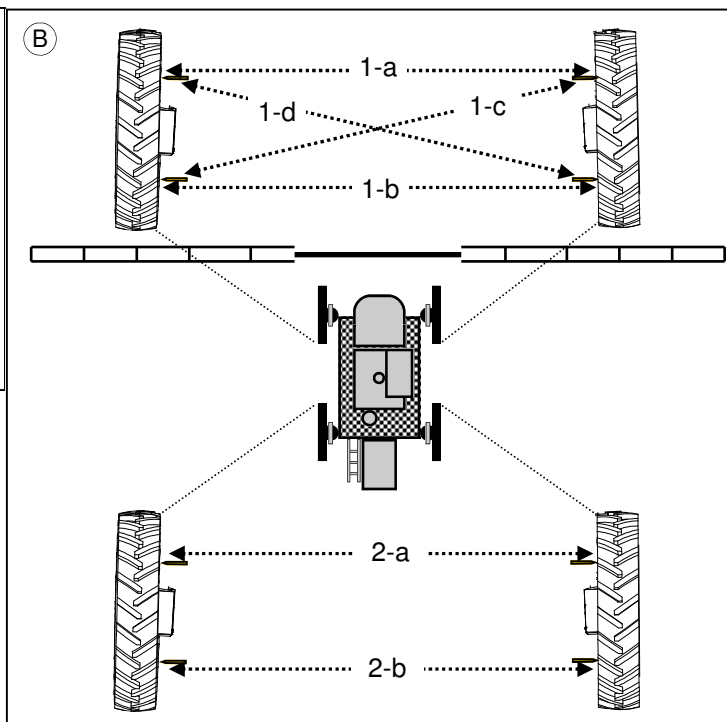

▲ Operators with machines equipped with All Wheel Steer pay special attention!



# SERVICE: TOE-IN

## Toe-in Adjustment \*

To adjust toe-in of the front tires follow these instructions for both front steering cylinders carefully:

1. Phase the cylinders, stopping at "center".
2. Loosen jam nut (A).
3. Screw swivel assembly in or out on steering cylinder until the measurement from the center of the rod end to the collar (B) is the same on both of the front steering cylinders.
4. Tighten jam nut.
5. Phase cylinders again, re-check toe-in measurement. The cylinders must be phased anytime an adjustment is made to the cylinders.
6. Drive forward 30 to 50 feet and recheck toe-in.
7. Repeat steps 2-6 until a correct toe-in measurement is reached.

\*Toe-in procedures are intended for conventional steer machines only. If AWS is installed on the machine, contact Hagie Customer Service for assistance. ▲

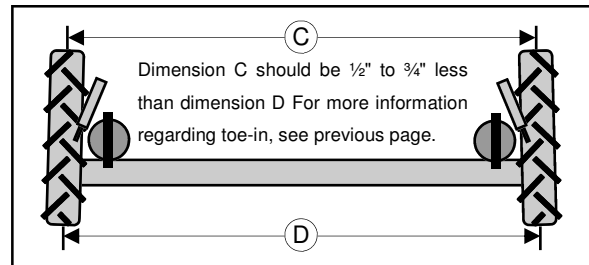
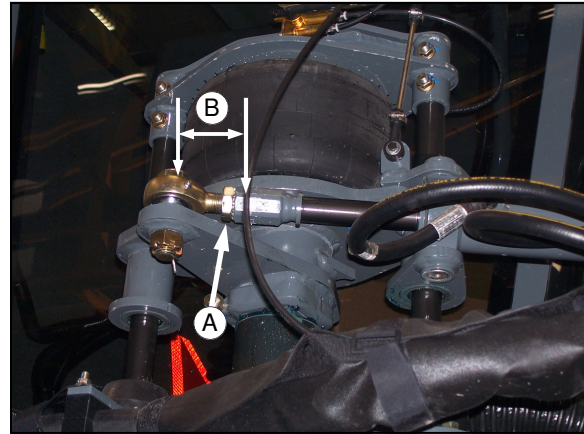

▲ Operators with machines equipped with All Wheel Steer pay special attention!

# SERVICE: MISC.

## Air Bag Pressure

The airbags (A) automatically adjust pressure to compensate for load weight and field conditions. The system includes an air dryer (B) that dries the air coming from the air compressor before sending it to a collection tank. Check the dryer cartridge every 50 hours to make sure that it is purging with compressor unload. Change the cartridge as needed or every other season (1000 hours).

From the collection tank, the air is sent to the airbags located on the legs (A) as needed to maintain a level pressure. There are control valves on each leg that open and close to allow air in.

Visually check the air bags daily for leaks and cracking. If an air bag seems to be low check the bag for any punctures or leaks. Call Hagie Customer Service for repairs.

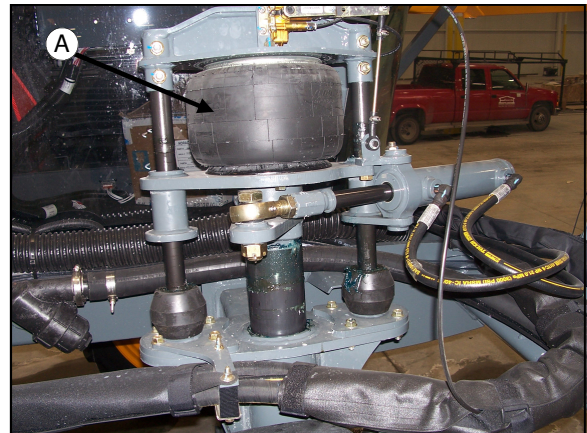

## Air Tank

Drain the air tank daily by slowly releasing the drain cock. Check for moisture in the system. If there is excessive moisture in this tank, there may be a problem with the system. Call Hagie Customer Support for assistance.

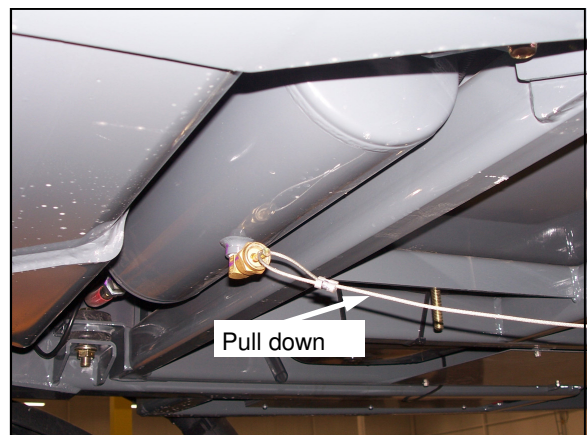

# SERVICE: MISC.

## Wet Tank

Drain the wet tank daily to prevent system condensation from contaminating the engine air compressor or dryer.



## Tire Pressure

Check the pressure once a week or every 50 hours of operation (A). Never inflate a tire more than the recommended maximum air pressure. Use an air line with a locking air chuck and stand behind the tire tread while filling (B).

Tire pressure will depend on type of tire and size of load in the solution tank.

**!** **Caution:** When inflating tire use extension with in-line air gauge and clip on air chuck which will allow the operator to stand clear of tire side wall explosion trajectory.



# SERVICE: MISC.

## Spray Tips

At the beginning of each season, or as required, remove a random sample of spray tip caps (C) and inspect the nozzle tips. If they are plugged or worn, clean or replace them. **DO NOT** put your mouth to a spray tip to try to unplug it!

## Nozzle Diaphragms

At the beginning of each season, remove each nozzle body cap (A) and inspect the diaphragm (B) for wear or fit. Replace if necessary. Refer to accompanying manual containing nozzle information.

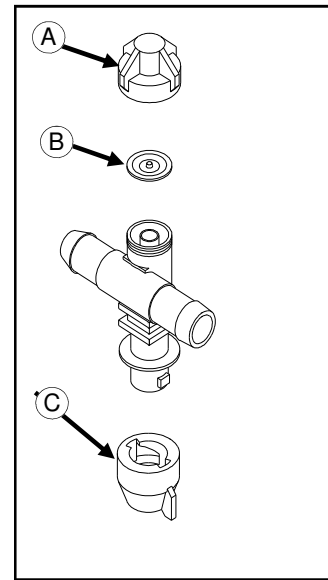

## Wiper Blade

Change the wiper blade as often as necessary. Do not allow the wiper blade to run on a dry windshield as this will shorten the life of the blade or cause scratching of the windshield.

Replace the blade with a 39 inch heavy duty blade of your choice.



# STORAGE

## Preparing For Storage

1. Perform daily level checks, lubrication, and bolt and linkage inspections as required in this manual in section seven on maintenance.
2. Every other season, drain the coolant from the engine and radiator. Probe the drain holes during draining to ensure they are not clogged by sludge, scale, or other deposits. Fill the cooling system to the top with a 50/50 water/antifreeze mixture. Run the engine to operating temperature and re-check the level.
3. Add a fuel stabilizer to the fuel and fill the tank.
4. Run the engine until it is at operating temperature, then drain the engine oil. Refill with fresh oil of recommended weight and install a new lubricating oil filter element.
5. With the engine at normal operating temperature, cycle all hydraulic functions including the steering.
6. Release tension on all belts.
7. Use plastic bags and water resistant adhesive tape to seal the air intake opening, all exhaust manifold openings, engine oil filter cap, hydraulic oil tank breather cap, and fuel tank caps.
8. Disconnect and remove batteries. Completely clean and charge the batteries. Coat the terminals with dielectric grease and store the batteries in a cool, above freezing place.
9. Thoroughly clean the sprayer. Touch up any painted surfaces that are scratched or chipped. For touch up paint recommendations contact the Hagie Manufacturing Customer Support Department.
10. Replace worn or missing decals. See Section 1 for proper location of warning decals and their corresponding part number. Warning decals and all other Hagie decals are available through the Hagie Customer Support Department.
11. Use a multi-purpose grease to coat exposed hydraulic cylinder rods.
12. To winterize the spray system, it is recommended that you use an environmentally safe type anti-freeze and water mixture that will give you adequate protection to minus 30 degrees below zero. Drain any remaining solution in the spray system and run the antifreeze mixture through the spray system until it comes out all boom openings. Repeat the above process with both the foam marker and rinse systems.
13. Refer to the Raven manual for detailed information on storage procedures for the console and flow meters.
14. If the sprayer must be stored outside, cover it with a waterproof cover.

For replacement decals contact:  
Hagie Manufacturing Company  
721 Central Ave. West  
Box 273  
Clarion, IA 50525-0273  
Ph. 1-800-247-4885

# STORAGE

## Removing From Storage

1. Inspect the condition, and test the air pressure of all the tires.
2. Carefully unseal all openings that were sealed in the storage process.
3. Clean and reinstall the batteries. Be sure to attach the battery cables to the proper terminals.
4. Tighten all belts. Inspect and replace any worn belts.
5. Check the engine oil, hydraulic oil, and engine coolant levels; add if necessary. A mixture of 50/50 antifreeze and water will cool adequately in summer as well as protect in winter.
6. Completely clean the sprayer.
7. Review section seven on maintenance and perform all needed services as instructed.
8. For starting instructions, refer to section 4 on operating information.

## NOTICE

Protective compounds such as grease can harden under exposure to weather conditions. Be sure to remove any dried grease and re-apply new if necessary.

# TROUBLESHOOTING



**Start engine from operator's seat only.**  
**When running engine in a building, be sure there is adequate ventilation.**

PROBLEM	POSSIBLE CAUSE	SUGGESTED REMEDY
Engine won't crank	<ul style="list-style-type: none"> <li>• Dead battery</li> <li>• Poor battery connections</li> <li>• Starter or starter relay</li> <li>• Blown fuse in engine electric box</li> <li>• Battery switch in OFF position</li> </ul>	<ul style="list-style-type: none"> <li>• Recharge or replace battery</li> <li>• Clean and tighten</li> <li>• Test; rebuild or replace</li> <li>• Check 20 amp fuse</li> <li>• Turn battery switch to ON position</li> </ul>
Engine won't start	<ul style="list-style-type: none"> <li>• Out of fuel</li> <li>• Clogged fuel filter</li> <li>• Cold weather</li> <li>• Low starter speed</li> <li>• Blown fuse in engine electric box</li> </ul>	<ul style="list-style-type: none"> <li>• Fill fuel tank</li> <li>• Replace fuel filters</li> <li>• Refer to engine manual for cold weather starting</li> <li>• Check starter and battery</li> <li>• Check 20 amp fuse</li> </ul>
Engine overheats	<ul style="list-style-type: none"> <li>• Engine overloaded</li> <li>• Dirty radiator core or dirty grill screen</li> <li>• Faulty radiator cap</li> <li>• Loose or faulty fan belt</li> <li>• Faulty thermostat</li> <li>• Low coolant level</li> </ul>	<ul style="list-style-type: none"> <li>• Reduce load</li> <li>• Remove all foreign material and clean all items</li> <li>• Replace cap</li> <li>• Tighten or replace fan belt</li> <li>• Replace thermostat</li> <li>• Refill to proper level with recommended coolant</li> </ul>

# TROUBLESHOOTING



Start engine from operator's seat only.  
When running engine in a building, be sure there is adequate ventilation.

PROBLEM	POSSIBLE CAUSE	SUGGESTED REMEDY
Engine misfires: runs uneven, low power	<ul style="list-style-type: none"><li>• Water in fuel</li><li>• Dirty air cleaner element</li><li>• Poor grade of fuel</li><li>• Fuel tank vent clogged</li><li>• Clogged fuel filter</li></ul>	<ul style="list-style-type: none"><li>• Drain, flush, replace filter, fill system</li><li>• Replace element</li><li>• Drain system, change to a better grade fuel</li><li>• Open fuel tank vent in cap</li><li>• Replace fuel filter</li></ul>
Engine knocks	<ul style="list-style-type: none"><li>• Low oil level in crankcase</li><li>• Cold engine</li></ul>	<ul style="list-style-type: none"><li>• Add oil to full mark</li><li>• Allow proper warm-up period; refer to engine owner's handbook</li></ul>



# TROUBLESHOOTING



PROBLEM	POSSIBLE CAUSE	SUGGESTED REMEDY
Solution pump will not prime	<ul style="list-style-type: none"> <li>• Low water level in pump</li> <li>• Air leak in suction line</li> <li>• Solution tank valve closed</li> </ul>	<ul style="list-style-type: none"> <li>• Make sure the solution tank is not empty, solution pump is self-priming</li> <li>• Inspect and tighten all fittings on suction line</li> <li>• Open solution tank valve, allow air to leave the system</li> </ul>
Erratic reading on pressure gauge	<ul style="list-style-type: none"> <li>• Orifice in back of gauge clogged</li> <li>• Faulty gauge</li> <li>• Air leak in suction line</li> <li>• Glycerin leaking from gauge</li> </ul>	<ul style="list-style-type: none"> <li>• Remove gauge; clean orifice; reinstall</li> <li>• Replace gauge</li> <li>• Inspect and tighten all fittings in suction line</li> <li>• Replace gauge</li> </ul>
Malfunction of electric solution valve	<ul style="list-style-type: none"> <li>• Faulty ground</li> <li>• Dirty contact terminals</li> <li>• Separation in wire</li> <li>• Faulty switch</li> <li>• Short in solenoid coil</li> <li>• Bad valve</li> </ul>	<ul style="list-style-type: none"> <li>• Clean and tighten ground</li> <li>• Clean contact terminals</li> <li>• Check continuity and replace wire</li> <li>• Replace switch</li> <li>• Replace valve</li> <li>• Replace valve</li> </ul>

# TROUBLESHOOTING

## NOTICE

If your machine is equipped with a high-pressure system, call the Hagie Manufacturing Customer Service Department for possible causes and suggested remedies.

PROBLEM	POSSIBLE CAUSE	SUGGESTED REMEDY
Solution pump not producing normal pressure	<ul style="list-style-type: none"> <li>• Clogged line strainer screen</li> <li>• Air leak in suction flow to pump</li> <li>• Restricted solution flow to pump</li> <li>• Suction hose collapsed</li> <li>• Internal restriction of diaphragm such as build up of chemical</li> <li>• Hydraulic failure</li> </ul>	<ul style="list-style-type: none"> <li>• Remove screen; clean thoroughly; tighten strainer cap to avoid air leak</li> <li>• Inspect and tighten all fittings on suction line</li> <li>• Main solution tank shut-off valve not completely open</li> <li>• Obstruction at inlet end of hose causing high vacuum on hose</li> <li>• Disassemble; inspect; clean; reassemble</li> <li>• Call Hagie Customer Service</li> </ul>

## NOTICE

Refer to the Raven installation and operation manual for trouble shooting guide on Raven console and system

# TROUBLESHOOTING

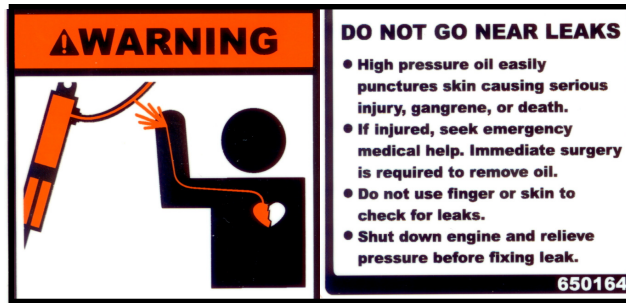

PROBLEM	POSSIBLE CAUSE	SUGGESTED REMEDY
Machine won't move in either direction	<ul style="list-style-type: none"> <li>• Speed control is set too low</li> <li>• Engine speed too low</li> <li>• Oil level in reservoir too low</li> <li>• Clogged filter</li> <li>• Hydrostatic system failure</li> </ul>	<ul style="list-style-type: none"> <li>• Adjust the setting of the speed control knob</li> <li>• Set engine at operating RPM before trying to move machine</li> <li>• Fill reservoir to proper level with approved oil; see section on service and maintenance</li> <li>• Replace filter</li> <li>• Call Hagie Customer Service</li> </ul>

# TROUBLESHOOTING



PROBLEM	POSSIBLE CAUSE	SUGGESTED REMEDY
Machine will move in only one direction	<ul style="list-style-type: none"> <li>• Speed control is set too low</li> <li>• Hydrostatic system failure</li> </ul>	<ul style="list-style-type: none"> <li>• Adjust the setting of the speed control knob</li> <li>• Call Hagie Customer Service</li> </ul>
Hydrostatic system responding slowly	<ul style="list-style-type: none"> <li>• Engine speed too low</li> <li>• Oil in reservoir low</li> <li>• Cold oil</li> <li>• Plugged filter</li> <li>• Partially restricted suction line</li> <li>• Hydrostatic system failure</li> </ul>	<ul style="list-style-type: none"> <li>• Set engine at operating RPM before trying to move machine</li> <li>• Fill reservoir to proper level with approved oil; see section on service and maintenance</li> <li>• Allow adequate warm up period</li> <li>• Check and replace filter</li> <li>• Inspect for collapsed suction hose</li> <li>• Call Hagie Customer Service</li> </ul>
Noisy hydrostatic system	<ul style="list-style-type: none"> <li>• Cold oil</li> <li>• Low engine speed</li> <li>• Oil level in reservoir low</li> <li>• Hydrostatic system failure</li> </ul>	<ul style="list-style-type: none"> <li>• Allow adequate warm up period</li> <li>• Increase engine speed</li> <li>• Fill reservoir to proper level with approved oil; see section on service and maintenance</li> <li>• Call Hagie Customer Service</li> </ul>



# TROUBLESHOOTING



PROBLEM	POSSIBLE CAUSE	SUGGESTED REMEDY
Entire hydraulic system fails to function	<ul style="list-style-type: none"> <li>• Oil level in reservoir too low</li> <li>• Auxiliary hydraulic system failure</li> </ul>	<ul style="list-style-type: none"> <li>• Fill reservoir to proper level with approved oil; see section on service and maintenance</li> <li>• Call Hagie Customer Service</li> </ul>
Noisy hydraulic pump	<ul style="list-style-type: none"> <li>• Oil level in reservoir too low</li> <li>• Auxiliary hydraulic system failure</li> </ul>	<ul style="list-style-type: none"> <li>• Fill reservoir to proper level with approved oil; see section on service and maintenance</li> <li>• Call Hagie Customer Service</li> </ul>

# TROUBLESHOOTING

**CAUTION**

Batteries contain sulfuric acid. Avoid contact with skin, eyes, or clothing. Do not inhale fumes or ingest liquid. Batteries contain gases which can explode. Keep sparks and flame away while servicing.

PROBLEM	POSSIBLE CAUSE	SUGGESTED REMEDY
Entire electrical system is dead	<ul style="list-style-type: none"> <li>Dead battery</li> <li>Poor battery connection</li> <li>Low charging rate</li> <li>No charging rate</li> <li>Battery master switch is in OFF position</li> </ul>	<ul style="list-style-type: none"> <li>Replace battery</li> <li>Clean and tighten battery connections</li> <li>Tighten alternator belt</li> <li>Replace alternator</li> <li>Turn battery master switch to ON position</li> </ul>
Light system does not function	<ul style="list-style-type: none"> <li>Poor ground</li> <li>Burned out bulb</li> <li>Separation or short in wire</li> <li>Blown fuse</li> <li>Faulty switch</li> <li>Ignition switch is off</li> </ul>	<ul style="list-style-type: none"> <li>Clean and tighten ground</li> <li>Replace bulb</li> <li>Check continuity and replace wire</li> <li>Replace fuse</li> <li>Replace switch</li> <li>Turn ignition switch to ON position</li> </ul>

## NOTICE

Disconnect battery when servicing any part of the electrical system to prevent system damage.

# TROUBLESHOOTING

## NOTICE

Be sure to make yourself familiar with the machine in both coordinated and conventional steering before attempting to use the machine for its intended purposes! 

PROBLEM	POSSIBLE CAUSE	SUGGESTED REMEDY
AWS system will not turn ON	<ul style="list-style-type: none"> <li>• AWS switch not ON</li> <li>• Machine not in WORK mode</li> <li>• Machine is not in first speed range</li> <li>• Sensor or valve malfunction</li> </ul>	<ul style="list-style-type: none"> <li>• Turn switch ON</li> <li>• Bring the machine to the neutral positions and turn the WORK mode switch ON</li> <li>• Use the shift buttons to shift down into the first speed range</li> <li>• Contact Hagie Customer Service</li> </ul>
AWS system is ON, but rear tires do not follow behind the front tires	<ul style="list-style-type: none"> <li>• Machine is being shifted out of the first speed range before turn is complete</li> <li>• Sensor or valve malfunction</li> </ul>	<ul style="list-style-type: none"> <li>• This is left up to the operator's discretion</li> <li>• Contact Hagie Customer Service</li> </ul>
AWS system does not work, machine will only move slow	<ul style="list-style-type: none"> <li>• Operator should see sensor malfunction message</li> </ul>	<ul style="list-style-type: none"> <li>• Contact Hagie Customer Service</li> </ul>

 Operators with machines equipped with All Wheel Steer pay special attention!

# TROUBLESHOOTING

---

## NOTES



# WARRANTY

## **Hagie Manufacturing Company Product Warranty**

Hagie Manufacturing Company warrants each new Hagie (including Vammas by Hagie) product to be free under normal use and service from defects in workmanship and materials for a period of lesser of: two (2) years or 1000 hours from the date of delivery on all Agricultural Products and two (2) years or 2000 hours on all Vammas By Hagie Snow Removal Equipment (SRE). Hagie Manufacturing Company makes this warranty from the original delivery date and is transferable to a purchaser from the original purchaser of this equipment, given there is remaining time left under the year and hour warranty standard stated above. This warranty shall be fulfilled by repairing or replacing free of charge any part that shows evidence of defect or improper workmanship, provided the part is returned to Hagie Manufacturing Company within thirty (30) days of the date that such defect or improper workmanship is discovered, or should have been discovered. Labor to repair said items will be covered by standard labor time rates. Freight charges of defective parts are not covered by this warranty and are the responsibility of the purchaser. No other express warranty is given and no affirmation of Hagie Manufacturing Company, by words or action, shall constitute a warranty.

Hagie Manufacturing Company limits its warranty to only those products manufactured by Hagie Manufacturing Company (including Vammas by Hagie) and does not warrant any part or component not manufactured by Hagie Manufacturing Company (including Vammas by Hagie), such as parts or components being subject to their manufacturer's warranties, if any. Excluded from this warranty are parts subjected to accident, alteration, or negligent use or repair. This warranty does not cover normal maintenance such as engine tune ups, adjustments, inspections, nor any consumables such as tires, rubber products, solution system valves, wear parts, wiper blades, etc.

Hagie Manufacturing Company shall not be responsible for repairs or replacements which are necessitated, in whole or in part; by the use of parts not manufactured by or obtainable from Hagie Manufacturing Company nor for service performed by someone other than Hagie authorized personnel, unless authorized by Hagie Manufacturing Company. Customer acknowledges that it is not relying on Hagie Manufacturing Company's skill or judgment to select finish goods for any purpose and that there are no warranties which are not contained in this agreement.

In no event shall Hagie Manufacturing Company's tort, contract, or warranty liability exceed the purchase price of the product. The foregoing limitation will not apply to claims for personal injury caused solely by Hagie Manufacturing Company's negligence.

Hagie Manufacturing Company shall not be liable for damages, including special, incidental or consequential damages or injuries (damage and repairs of equipment itself, loss of profits, rental or substitute equipment, loss of good will, etc.) arising out of or in connection with performance of the equipment or its use by customer, and Hagie Manufacturing Company shall not be liable for any special, incidental or consequential damages arising out of or in connection with Hagie Manufacturing Company's failure to perform its obligation hereunder. HAGIE MANUFACTURING COMPANY'S ENTIRE LIABILITY AND THE CUSTOMER'S EXCLUSIVE REMEDY SHALL BE REPAIR OR REPLACEMENT OF PARTS COVERED UNDER THIS WARRANTY. THIS WARRANTY IN LIEU OF ALL OTHER WARRANTIES, EXPRESSED OR IMPLIED, INCLUDING, BUT NOT LIMITED TO THE IMPLIED WARRANTY OF MERCHANTABILITY OR FITNESS FOR A PARTICULAR PURPOSE.

# INDEX

<b>A</b>	
A/C Compressor Belt.....	100-2
ACE (Automatically Controlled Engine).....	35-6
Adjusting Service Intervals.....	30-14
Air Bag Pressure.....	115-1
Air Ride Seat.....	25-23 * 25-26
Absorber Adjustment.....	25-25
Armrest Tilt Adjustment.....	25-25
Backrest Adjustment.....	25-25
Fore/Aft Adjustment.....	25-24
Fore/Aft Isolator.....	25-23
Height and Weight Adjustment.....	25-23
Lumbar Support Adjustment.....	25-24
Seat Depth Adjustment.....	25-24
Seat Pan Angle Adjustment.....	25-24
Optional Seat.....	25-26
Air Tank.....	115-1
Agitation Operation.....	45-9
Agitation Switch.....	25-9
All Wheel Steer.....	05-10, 60-1 * 60-8
Components.....	60-4
Operating.....	60-5
Switch.....	30-11
Terminology.....	60-3
Tips.....	60-6
Auxiliary Hydraulic System.....	40-3
<b>B</b>	
Batteries.....	95-1
Charging.....	
Cleaning.....	
Service Access.....	
Battery Acid Accident Prevention.....	05-6
Battery Disconnect.....	35-5
Beacon, Rotating.....	61-7
Boom Sensor Page.....	30-15
Boom Extension Switch.....	25-9
Boom Solution Valve L.E.D Indicators.....	45-7
Boom Solution Valve Switch.....	25-9
Boom Stands.....	55-3, 55-9
Buddy Seat.....	25-23
<b>C</b>	
CE Certification.....	61-1
Cab Glass.....	25-21
Charcoal Cab Filter.....	85-6
Chemical Safety.....	05-7
Circuit Breakers.....	95-2
Climate Controls.....	25-17
Clock.....	30-6
Cooling System.....	80-3 * 80-4
Courtesy Light/ Interior Work Light.....	25-14
Cradling the Booms.....	70-1
<b>D</b>	
Decals.....	10-1*10-9
Drive State.....	30-10
Driving the Sprayer.....	70-2
<b>E</b>	
E-Stop (Emergency Stop).....	61-7
Emergency Exit Tool (Res-Q-Me).....	25-22
Engine.....	35-2
Starting.....	35-4
Engine Air Intake Filter.....	85-1
Engine Diagnostic Port.....	25-11
Engine Drive Belt.....	100-1
Engine Lube Filter.....	85-3
Engine Oil.....	80-1
<b>F</b>	
“F” Buttons.....	30-10 * 30-12
All Wheel Steer (F3).....	30-11
Drive State (F1).....	30-10
F2.....	30-11
Float (F4).....	30-12
Fan, Reversible.....	62-1
Fence Row Applicator.....	45-13
Fence Row Switch.....	25-10
Field Lights.....	25-19
Filter Minder®.....	85-2
Flow Meter.....	45-6
Fluid Capacities and Types.....	80-5
Foam Marker.....	
Filling.....	50-2
Operation.....	50-1 * 50-2
Switch.....	25-12
Forward.....	25-8
Fresh Air Filters.....	25-22
Charcoal Filter.....	85-6
Paper Filter.....	85-6
Front Console.....	25-1 * 25-4
Hazard/Warning Lights.....	25-2
Highway Running Lights.....	25-2
Horn.....	25-3
Ignition Switch.....	25-3
Steering Column Release Pedal.....	25-4
Tilt Adjust Handle.....	25-4
Turn Signals.....	25-2
Fuel.....	80-4
Fuel Filters and Strainers.....	85-4
Primary Fuel Filter (Water Separator).....	
Remote Filter.....	
Fuel Gauge.....	30-9
Fuses.....	95-2

# INDEX

<b>G</b>		<b>K</b>	
Gear Display .....	30-9	Ladder .....	40-5
Grease Zerks .....	90-1 * 90-2	Level .....	25-12,40-12
Ladder.....	90-1	Lift .....	25-12,40-11
Legs and Steering.....	90-1	Lights	
Transom Pivot Tubes.....	90-2	Field Lights.....	25-19
		Hazard/Warning Lights.....	25-2
		Highway Running Lights.....	25-2
		Turn Signals .....	25-2
		Work Lights .....	25-19
		Loading the Sprayer .....	70-4
<b>H</b>		<b>M</b>	
Hagie Diagnostic Port.....	25-11	Machine Hours .....	30-13
Hand Washing System.....	45-14	Main Solution Switch .....	25-12, 45-10
Hazard/Warning Lights.....	25-2	Main Spray Indicator.....	30-7
Highway Running Lights.....	25-2	MD3 .....	25-16
Home Page .....	30-6	Operating Instructions .....	30-1 * 30-15
Horizontal Extension .....	25-12,40-12	Adjusting Service Intervals.....	30-14
Horn .....	25-3	All Wheel Steer (F2).....	30-11
Hydraulic Filters and Strainers .....	85-3	Boom Sensor Page.....	30-15
Fill Screen		Buttons.....	30-1
Return Filter		Changing Tire Sizes.....	30-4
Suction Filter		Changing Unit of Measure .....	30-5
Hydraulic Oil Reservoir.....	80-1	Clock.....	30-6
Hydraulic System .....	40-1 * 40-14	Display Lighting .....	30-3
Auxiliary Hydraulic System.....	40-3	Drive State (F1) .....	30-10
Components.....	40-1 * 40-2	F2 Function Button .....	30-11
Hydraulic Tread Adjust.....	40-6	Float (F4) .....	30-12
Ladder.....	40-5	Fuel Gauge.....	30-9
Power Steering System.....	40-4	Gear Display.....	30-9
Recalibrate Toe-In (phasing).....	40-7	Home Page.....	30-6
Spray Booms .....	40-8 * 40-14	Machine Hours.....	30-13
Solution Pump.....	40-4	Main Spray Indicator .....	30-7
Hydraulic Tread Adjust.....	40-6	Menu Screens.....	30-3
Bolt Torque .....	105-2 * 105-3	Misc. Page .....	30-15
Hydrostatic Drive System .....	35-1 * 35-7	Pages.....	30-2
ACE (Automatically Controlled Engine).....	35-6	Refer to Operator's Manual.....	30-7
Battery Disconnect.....	35-5	Resetting Service Hours .....	30-14
Components.....	35-1	Software Version .....	30-4
Engine.....	35-2	Speedometer .....	30-9
Parking Brake .....	35-5	Tachometer.....	30-8
Pre-operational Checks.....	35-3	Temperature Gauge.....	30-8
Speed Control.....	35-7	Tread Setting (Misc. Page) .....	30-15
Starting the Engine .....	35-4	Warning Light Indicator .....	30-7
Wheel Hubs .....	35-2	Manual Fold (boom) .....	40-14
Wheel Motors.....	35-2	Misc. Page (MD3).....	30-15
Hydrostatic Lever .....	25-6		
<b>I</b>		<b>N</b>	
Identification .....	15-1 * 15-2	Neutral.....	25-8
Ignition Switch .....	25-3	Nozzle Diaphragms .....	115-3
Individual Boom Solution Valve Switches.....	45-7		
Inductor Operation.....	45-12		
Introduction .....	i		
<b>J</b>			

# INDEX

## O

OPS (Operator Presence Switch).....	61-7
Operator's Station	
Front Console .....	25-1 * 25-4
Hazard/Warning Lights Switch.....	25-2
Highway Running Lights Switch .....	25-2
Horn.....	25-3
Ignition Switch .....	25-3
Steering Column Release Pedal.....	25-4
Tilt Adjust Handle .....	25-4
Turn Signals .....	25-2
Other Features and Controls.....	25-21 * 25-25
Air Ride Seat .....	25-23 * 25-25
Absorber Adjustment .....	25-25
Armrest Tilt Adjustment .....	25-25
Backrest Adjustment.....	25-25
Fore/Aft Adjustment.....	25-24
Fore/Aft Isolator .....	25-23
Height and Weight Adjustment .....	25-23
Lumbar Support Adjustment.....	25-24
Seat Depth Adjustment.....	25-24
Seat Pan Angle Adjustment.....	25-24
Buddy Seat.....	25-23
Cab Glass.....	25-22
Emergency Exit Tool (Res-Q-Me).....	25-22
Fresh Air Filters .....	25-22
Rear Viewing Mirrors .....	25-22
Overhead Monitors and Controls .....	25-13 * 25-20
Climate Controls .....	25-17
Courtesy Light/ Interior Work Light .....	25-14
Field Lights .....	25-19
MD3.....	25-16
Raven Spray Systems Console .....	25-20
Spray System Indicator Light.....	25-16
Stereo.....	25-14
Vents .....	25-17
Warning Indicator Message.....	25-15
Windshield Wiper/ Washer Fluid Switches .....	25-18
Work Lights.....	25-19
Side Console.....	25-5 * 25-12
Agitation .....	25-9
Boom Extension Switch.....	25-9
Boom Solution Valve Switch.....	25-9
Engine Diagnostic Port.....	25-11
Fence Row Switch.....	25-10
Foam Marker Switch.....	25-12
Forward .....	25-8
Hagie Diagnostic Port.....	25-11
Horizontal Extension.....	25-12
Hydrostatic Lever.....	25-6

Level .....	25-12
Lift .....	25-12
Main Solution Switch.....	25-12
Neutral .....	25-8
Parking Brake .....	25-7
Power Ports .....	25-11
Speed Control.....	25-6
Reverse .....	25-8
Rinse Switch.....	25-9
Tank Switch .....	25-9
Throttle Switch.....	25-7
Tread Adjust Switch.....	25-10
Warning Buzzer .....	25-11
Other Features and Controls .....	25-21 * 25-25
Air Ride Seat .....	25-23 * 25-25
Absorber Adjustment .....	25-25
Armrest Tilt Adjustment.....	25-25
Backrest Adjustment.....	25-25
Fore/Aft Adjustment .....	25-24
Fore/Aft Isolator .....	25-23
Height and Weight Adjustment .....	25-23
Lumbar Support Adjustment .....	25-24
Seat Depth Adjustment.....	25-24
Seat Pan Angle Adjustment .....	25-24
Buddy Seat.....	25-23
Cab Glass .....	25-22
Emergency Exit Tool (Res-Q-Me) .....	25-22
Fresh Air Filters .....	25-22
Rear Viewing Mirrors .....	22-22
Overhead Monitors and Controls.....	25-13 * 25-20
Climate Controls.....	25-17
Courtesy Light/ Interior Work Light .....	25-14
Field Lights.....	25-19
MD3.....	25-16
Raven Spray Systems Console.....	25-20
Spray System Indicator Light .....	25-16
Stereo.....	25-14
Vents .....	25-17
Warning Indicator Message.....	25-15
Windshield Wiper/ Washer Fluid Switches .....	25-18
Work Lights .....	25-19

## P

Paper Cab Filter .....	85-6
Parking Brake .....	25-7, 35-5
Phasing (Recalibrate Toe- In).....	40-7
Poly Rinse Tank Strainer .....	85-5
Power Ports.....	25-11
Power Steering.....	40-4
Pre-operational Checks .....	35-3
Proposition 65 Warning .....	inside cover

# INDEX

## Q

Quick-Tach System .....	55-1 * 55-9
Boom Stands .....	55-3, 55-9
Disconnect .....	55-5
Lock Assemblies .....	55-4
Lowering the boom .....	55-4
Opening the Boom .....	55-4
Storage .....	55-2

## R

Radiator Grille Screen .....	85-2
Raven Spray Control Console .....	25-20, 65-1 * 65-16
Boom Cal .....	65-10 * 65-12
Contrast Adjustment .....	65-4
Introduction .....	65-1
Meter Cal .....	65-6
Product High Offset .....	65-13
Product Low Offset .....	65-14
Product Type .....	65-5
Rate Cal .....	65-7
Self Test .....	65-16
Speed Cal .....	65-9
Tank Volume .....	65-14
Tip Selection .....	65-1 * 65-2
Unit of Measure .....	65-4
Valve Cal .....	65-17
Valve Type .....	65-5
Verifying Calibration .....	65-15
Wheel Sensor Type .....	65-8
Rear Viewing Mirrors .....	25-22
Resetting Service Hours .....	30-14
Reverse ..	25-8
Reversible Fan .....	62-1
Rinse Strainer .....	85-5
Rinse Switch .....	25-9
Rinse System .....	45-15

## S

Safety ....	05-1 * 05-10
Seat (Air Ride) .....	25-23 * 25-25
Absorber Adjustment .....	25-25
Armrest Tilt Adjustment .....	25-25
Backrest Adjustment .....	25-25
Fore/Aft Adjustment .....	25-24
Fore/Aft Isolator .....	25-23
Height and Weight Adjustment .....	25-23
Lumbar Support Adjustment .....	25-24
Seat Depth Adjustment .....	25-24
Seat Pan Angle Adjustment .....	25-24
Service: Belts .....	100-1 * 100-2
A/C Compressor Belt .....	100-2
Engine Drive Belt .....	100-1

Service: Bolt Torque .....	105-1 * 105-3
Hydraulic Tread Adjust .....	105-2 * 105-3
Wheel Bolts .....	105-1
Service: Electrical .....	95-1 * 95-2
Batteries .....	95-1
Fuses and Circuit Breakers .....	95-2
Service: Filters .....	85-1 * 85-6
Engine Air Intake .....	85-1
Engine Lube Filter .....	85-3
Filter Minder® .....	85-2
Fresh Air Cab Filters .....	85-6
Charcoal Filter	
Paper Filter	
Fuel Filters and Strainers .....	85-4
In-Line Strainer	
Primary Fuel Filter (Water Separator)	
Remote Fuel Filter	
Hydraulic Filters and Strainers .....	85-3
Fill Screen	
Return Filter	
Suction Filter	
Other Strainers .....	85-5
Poly Rinse Tank Strainer	
Rinse Strainer	
Solution Line "Y" Strainer	
Radiator Screen .....	85-2
Strainer Basket .....	85-3
Service: Fluids .....	80-1 * 80-5
Air Conditioning .....	80-5
Cooling System .....	80-3 * 80-4
Engine Oil .....	80-1
Fuel ..	80-4
Hydraulic Oil .....	80-1
Wheel Hub Oil .....	80-2
Windshield Washer Fluid .....	80-5
Service Intervals .....	75-1 * 75-3
Adjusting Service Intervals .....	30-14
Resetting Service Hours .....	30-14
Service: Lubrication .....	90-1 * 90-2
Ladder .....	90-1
Legs and Steering .....	90-1
Transom Pivot Tubes .....	90-2
Service: Misc. ....	115-1 * 115-3
Air Bag Pressure .....	115-1
Air Tank .....	115-1
Nozzle Diaphragm .....	115-3
Spray Tips .....	115-3
Tire Pressure .....	115-2
Wet Tank .....	115-2
Wiper Blade .....	115-3
Service Toe- In .....	110-1 * 110-2

# INDEX

Gauging Toe-In .....	110-1	Manual Folding.....	40-14
Toe-In Adjustment.....	110-2	Vertical Extension.....	40-13
Side Console.....	25-5 * 25-12	Spray System .....	45-1 * 45-15
Agitation Switch .....	25-9	Agitation .....	45-9
Boom Extension Switch .....	25-9	Boom Solution Valve L.E.D. Indicators.....	45-7
Boom Solution Valve Switch .....	25-9	Components.....	45-2 * 45-3
Engine Diagnostic Port.....	25-11	Fence Row Applicator .....	45-13
Foam Marker Switch .....	25-12	Flow Meter .....	45-6
Fence Row Switch .....	25-10	Hand Washing System.....	45-14
Forward.....	25-8	Individual Boom Solution Valve Switches.....	45-7
Hagie Diagnostic Port .....	25-11	Inductor Operation.....	45-12
Horizontal Extension .....	25-12	Main Solution Switch .....	45-10
Hydrostatic Lever .....	25-6	Rinse System .....	45-15
Level .....	25-12	Solution Pressure Gauge .....	45-6
Lift .....	25-12	Solution Pump.....	45-4
Main Solution Switch.....	25-12	Solution Tank .....	45-4
Neutral .....	25-8	Solution Tank Valve .....	45-8
Parking Brake .....	25-7	Solution Quick Fill.....	45-11
Power Ports .....	25-11	Tank Sump Valve .....	45-8
Speed Control.....	25-6	Spray System Indicator Light.....	25-16
Reverse.....	25-8	Spray Tips .....	115-3
Rinse Switch .....	25-9	Starting the Engine .....	35-4
Tank Switch .....	25-9	Steering Column Release Pedal.....	25-4
Throttle Switch .....	25-7	Stereo.....	25-14
Tread Adjust Switch .....	25-10	Storage.. .....	120-1 * 120-2
Warning Buzzer .....	25-11	Strainer Basket.....	85-3
Software Version.....	30-4		
Solution Line "Y" Strainer .....	85-5	<b>T</b>	
Solution Pump.....	40-4	Table of Contents .....	iii
Solution Pump Pressure Gauge .....	45-6	Tachometer .....	30-8
Solution Quick Fill.....	45-11	Tank Sump Valve .....	45-8
Solution Tank .....	45-4	Tank Switch.....	25-9
Solution Tank Valve .....	45-8	Temperature Gauge .....	30-8
Specifications .....	20-1 * 20-9	Throttle Switch.....	25-7
Auxiliary Hydraulic System.....	20-3	Tilt Adjust Handle .....	25-4
Cab and Instruments.....	20-7	Tire Pressure.....	115-2
Capacities .....	20-7	Tire Sizes.....	20-8 * 20-9
Dimensions .....	20-1	Changing Tire Sizes .....	30-4
Electrical System .....	20-5 * 20-6	Toe-In	
Engine.....	20-2	Adjusting Toe-In .....	110-2
Foam Marking System .....	20-4	Gauging Toe-In .....	110-1
Hydrostatic Drive.....	20-2	Recalibrate (phasing) .....	40-7
Rinse System.....	20-4	Transporting .....	70-1 * 70-4
Spray System.....	20-3	Cradling the Booms.....	70-1
Tires.. .....	20-8 * 20-9	Driving the Sprayer.....	70-2
Speed Control .....	25-6, 35-7	Loading .....	70-3
Speedometer.....	30-9	Unloading.....	70-4
Spray Booms.....	40-8	Tread Adjust (Hydraulic).....	40-6
Horizontal Boom Extension.....	40-12	Tread Adjust Switch.....	25-10
Level .....	40-11	Tread Setting (Misc. Page).....	30-15
Lift .....	40-10	Trouble Shooting .....	125-1 * 125-10
		Turn Signals .....	25-2

# INDEX

---

## U

Unit of Measure (MD3) .....	30-5
Unloading the Sprayer.....	70-4

## V

Vents ....	25-17
Vertical Extension.....	40-13

## W

Warning Buzzer.....	25-11
Warning Decals.....	10-1 * 10-7
Warning Indicator Message.....	25-15
Warning Light Indicator .....	30-7
Warning Symbols .....	ii
Warranty. ....	130-1
Wet Tank .....	115-2
Wheel Bolts .....	105-1
Wheel Hub Oil .....	80-2
Wheel Hubs.....	35-2
Wheel Motors .....	35-2
Windshield Washer Fluid.....	80-5
Windshield Wiper/ Washer Fluid Switches .....	25-18
Wiper Blade.....	115-3
Work Lights .....	25-19

## X

## Y

## Z

# NOTES

---