



TABLE OF CONTENTS

1 – INTRODUCTION

A Word From Hagie Manufacturing Company	1-1
About This Manual	1-1
Safety Messages Used In This Manual	1-2
Service and Assistance	1-2
Reporting Accidents, Injuries, or Safety Concerns	1-2
Identification	1-3
Specifications	1-6
2015 Product Warranty	1-17

2 – SAFETY AND PRECAUTIONS

Intended Use	2-1
Safety Precautions	2-1
Seat Belt	2-6
Rotating Beacons	2-7
Emergency Stop	2-7
Operator Presence Switch (OPS)	2-8
Emergency Exit	2-8
Fire Extinguisher	2-9
First Aid Kit	2-9
Roll-Over Protection Structure (ROPS)	2-10
Safety Decals	2-11

3 – CAB

Seat - Operator (Deluxe)	3-1
Seat - Operator (Premium)	3-2
Seat - Instructor	3-4
Operator's Station	3-5
Machine Display	3-29

4 – ENGINE AND DRIVE SYSTEMS

Engine - Starting	4-1
Engine Aftertreatment - Tier 4 Final	4-3
Hydrostatic Drive	4-10
All-Wheel Steer (AWS)	4-16

5 – HYDRAULIC SYSTEMS

Hydraulic System Components	5-1
Reversible Fan	5-5
Tread Adjustment	5-6
Ladder	5-8

6 – ELECTRICAL SYSTEMS

Batteries	6-1
Battery Disconnect Switch	6-2
Fuses and Relays	6-3
Fuse and Relay Ratings	6-7
Video Camera Input Connections	6-10

7 – SPRAY SYSTEMS

Spray Boom Hose Clamp Installation	7-1
Spray Booms - 90/100'	7-3
Spray Booms - 120/132'	7-13
Spray Boom - Rear	7-26
Solution System Components	7-28
Solution System - Operation	7-35
Droplet Monitoring System	7-38
Fence Row Applicator	7-40
Filling Your Solution Tank	7-41
Draining Your Solution Tank	7-45
Rinse System	7-46
Foam Marker System	7-50
Application	7-52

8 – DETASSELING SYSTEMS

Detasseling System Components	8-1
Detasseling System - Operation	8-9
4-2 Detasseler Combo Attachment - Adjustable	8-11
Tasseltrol®/LS System 12™	8-13
Tasseltrol Flowchart	8-23

9 – MAINTENANCE AND STORAGE

Service - Fluids	9-1
Service - Filters	9-9
Service - Lubrication	9-18
Service - Engine Drive Belt	9-23
Service - Bolt Torque	9-24
Service - Toe-In	9-25
Service - Miscellaneous	9-27
Service Intervals	9-32
Storage	9-36

10 – MISCELLANEOUS

Transporting	10-1
Lifting Your Machine	10-5
Quick-Tach System - Spray Booms	10-7
Quick-Tach System - Detasseler Combo	10-19
Air Suspension Exhaust	10-26



Hand Wash System	10-26
Hood Operation	10-28
Tall Corn Package - Installation	10-29
Troubleshooting	10-45



SECTION 1 – INTRODUCTION

The following patent decal is located along the frame behind the front right-hand leg and provides current patents issued on your machine.

NOTE: Hagie Manufacturing Company reserves the right to make changes to any current patents or patents pending at any time, without notice.



Hagie Manufacturing Patent Decal
(Located along the frame
behind the front right-hand leg)

A WORD FROM HAGIE MANUFACTURING COMPANY

Congratulations on the purchase of your STS Combo Sprayer! Read this operator’s manual and become familiar with operating procedures and safety precautions before attempting to operate your sprayer.

As with any piece of equipment, certain operating procedures, service, and maintenance are required to keep your machine in top running condition. We have attempted herein to cover all of the adjustments required to fit varying conditions. However, there may be times when special care must be considered.

NOTE: The operator is responsible for inspecting the machine and it’s attachments, as well as having parts repaired or replaced when continued use of the product causes damage or excessive wear to other parts.

Hagie Manufacturing Company reserves the right to make changes in the design and material of any subsequent sprayer without obligation to existing units.

Thank you for choosing a Hagie and we ensure you of our continued interest and support in its optimal performance for you. We are proud to have you as a customer!

ABOUT THIS MANUAL

NOTICE

Any pictures contained within this operator’s manual that depict situations with shields, guards, rails, or lids removed are for demonstration only. Hagie Manufacturing Company strongly urges the operator to keep all shields and safety devices in place at all times.

NOTICE

Reference to right and left-hand used throughout this manual refers to the position when seated in the operator’s seat facing forward.

This manual will aid you in the proper operation and service of your machine. It is the responsibility of the user to read the operator’s manual and comply with the correct and safe operating procedures, as well as maintain the product according to the service information provided in the *Maintenance and Storage Section* elsewhere in this manual.

Photographs and illustrations used in this manual are of general nature only. Some of the equipment and features shown may not be available on your machine.

Information described in this manual was correct at the time of printing. Because of Hagie Manufacturing Company's continuous product improvement, certain information may not be included in this manual.

Keep this manual in a convenient place for easy reference. This manual is considered a permanent fixture of the product. In the event of resale, this manual should accompany the machine.

If you do not understand any part of this manual or require additional information or service, contact the Hagie Research and Development department.

SAFETY MESSAGES USED IN THIS MANUAL

The following safety messages found throughout this manual alert you of situations that could become potentially dangerous to the operator, service personnel, or equipment.

 DANGER
This symbol indicates a hazardous situation which, if not avoided, will result in serious injury or death.

 WARNING
This symbol indicates a potentially hazardous situation which, if not avoided, could result in moderate/serious injury or death.

 CAUTION
This symbol indicates a potentially hazardous situation which, if not avoided, may result in minor or moderate injury. It may also be used to alert against unsafe practices.

NOTICE
This symbol indicates operator awareness which, if not avoided, may result in personal or property damage.

NOTE: A "Note" is intended to make special mention of, or remark on.

SERVICE AND ASSISTANCE

For service and assistance, please contact:

Hagie Manufacturing Company
721 Central Avenue West
P.O. Box 273
Clarion, IA 50525-0273
(515) 532-2861 OR (800) 247-4885
www.hagiehelp.com

REPORTING ACCIDENTS, INJURIES, OR SAFETY CONCERNS

Should an accident or injury occur involving the use of a Hagie product, or if you have a product safety concern, report such information directly to Hagie Customer Support at (800) 247-4885.

IDENTIFICATION

NOTICE

Reference to right and left-hand used throughout this manual refers to the position when seated in the operator's seat facing forward.

Each machine is identified by means of a frame serial number. This serial number denotes the model, year in which it was built, and the number of the sprayer.

For further identification, the engine, solution pump, hydraulic pumps, and attachments each have serial numbers, and the planetary wheel hubs have identification plates that describe the type of mount and gear ratio.

To ensure prompt, efficient service when ordering parts or requesting service repairs, record the serial numbers and identification numbers in the following spaces provided.

Sprayer

The sprayer serial number is stamped on the right-hand side frame (behind rear leg).



Sprayer Serial Number
-Typical View

Serial No. _____

Engine

The engine has an identification plate mounted on top of engine near the oil fill port that provides engine serial number, as well as other manufacturer information. Refer to your Parts Manual for specific part number.

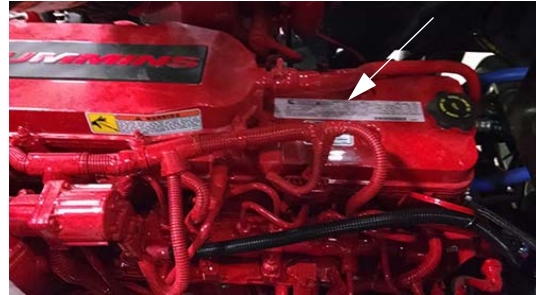

Engine Identification Plate
-Typical View

Serial No. _____

Solution Pump

The solution pump has an identification plate mounted on the side of pump that provides pump serial number, as well as other manufacturer information. Refer to your Parts Manual for specific part number.



Solution Pump Identification Plate
** View shown from beneath machine*
-Typical View

Serial No. _____

Hydraulic Pumps

The PC, LS, and Drive Pumps each have an identification plate mounted on the side of pump that provides pump serial number, as well as other manufacturer information. Refer to your Parts Manual for specific part number.

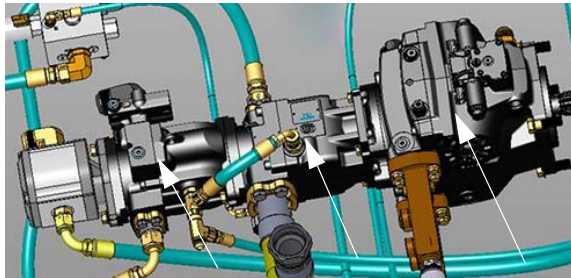

- PC Pump
- LS Pump
- Drive Pump

Hydraulic Pumps

* Top view shown

-Typical View

- _____ PC Pump
- _____ LS Pump
- _____ Drive Pump

Wheel Motors

The wheel motors each have an identification plate mounted on the side of motor that provides motor serial number, as well as other manufacturer information. Refer to your Parts Manual for specific part number.



Front

Rear

Wheel Motor Identification Plates -Typical View

- _____ Right Front
- _____ Right Rear
- _____ Left Front
- _____ Left Rear

Wheel Hubs

The wheel hubs each have an identification plate mounted on the front of hub that provides hub serial number, as well as other manufacturer information, including gear ratio. Refer to your Parts Manual for specific part number.



Wheel Hub Identification Plate -Typical View

- _____ Right Front
- _____ Right Rear
- _____ Left Front
- _____ Left Rear

Spray Boom

Steel Spray Booms (90/100')

The steel spray boom serial number is stamped on the bottom right-hand side of transom.

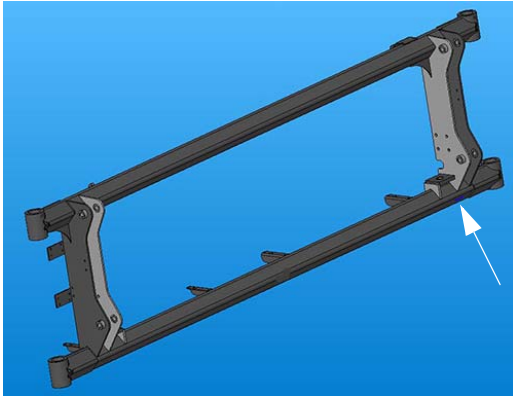

Steel Spray Boom Serial Number
-Typical View

Serial No. _____



Detasseler Combo Attachment
Serial Number
-Typical View

Serial No. _____

Aluminum Spray Booms (120/132')

The aluminum spray boom serial number is stamped on the lower right-hand side of fixed transom.

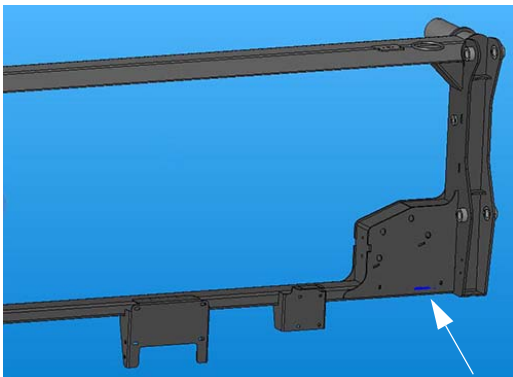

Aluminum Spray Boom Serial Number
-Typical View

Serial No. _____

Detasseler Combo Attachment

The detasseler combo attachment serial number is stamped on the main tool bar.

SPECIFICATIONS

NOTE: 320/105 R54 tires used for the following machine dimensions.

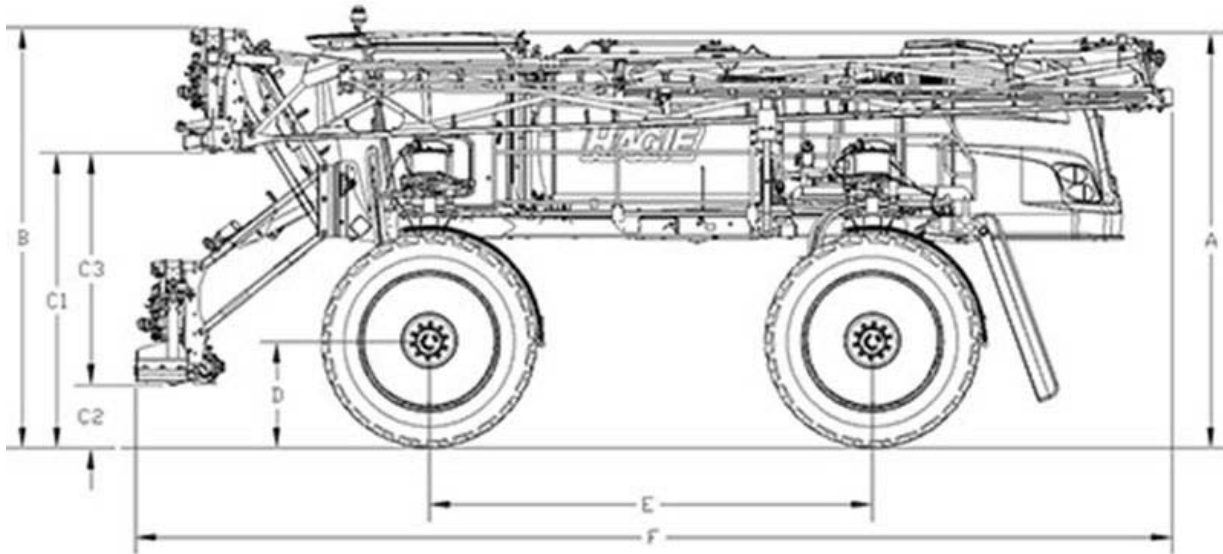

Detail	Description	Specification			
		90-ft. Boom	100-ft. Boom	120-ft. Boom	132-ft. Boom
A	Overall Sprayer Height (from top of cab) <i>NOTE: Sprayer height dimension does not include the cab-mounted rotating beacons or the optional GPS unit.</i>	154" ** (391.2 cm) **	154" ** (391.2 cm) **	154" ** (391.2 cm) **	154" ** (391.2 cm) **
B	Raised Transom Height	153" ** (388.6 cm) ** (from top of lights)	153" ** (388.6 cm) ** (from top of lights)	153" ** (388.6 cm) ** (from top of fixed transom)	153" ** (388.6 cm) ** (from top of fixed transom)
C3	Transom Lift Range (C1 minus C2)	86" (104" - 18") 218.4 cm (264.2-45.7 cm)	86" (104" - 18") 218.4 cm (264.2-45.7 cm)	86" (104" - 18") 218.4 cm (264.2-45.7 cm)	86" (104" - 18") 218.4 cm (264.2-45.7 cm)
D	Static Loaded Hub Height	38 3/8" ** (97.5 cm) **	38 3/8" ** (97.5 cm) **	38 3/8" ** (97.5 cm) **	38 3/8" ** (97.5 cm) **
E	Wheel Base	140" (355.6 cm)	140" (355.6 cm)	140" (355.6 cm)	140" (355.6 cm)
F	Sprayer Length	336" (853.4 cm)	336" (853.4 cm)	370" (939.8 cm)	410" (1041.4 cm)
G	Width (booms folded, 120"/304.8 cm tread)	144" (365.8 cm)	144" (365.8 cm)	177" (449.6 cm)	177" (449.6 cm)
H	Frame Clearance (to tread adjust bolts)	74" (188 cm) **	74" (188 cm) **	74" (188 cm) **	74" (188 cm) **
I	Lower Leg Clearance (from shield)	31" (78.7 cm) **	31" (78.7 cm) **	31" (78.7 cm) **	31" (78.7 cm) **
J	Tread Width*	122" - In ** (309.9 cm - In) ** 154" - Out ** (391.2 cm - Out) **	122" - In ** (309.9 cm - In) ** 154" - Out ** (391.2 cm - Out) **	122" - In ** (309.9 cm - In) ** 154" - Out ** (391.2 cm - Out) **	122" - In ** (309.9 cm - In) ** 154" - Out ** (391.2 cm - Out) **

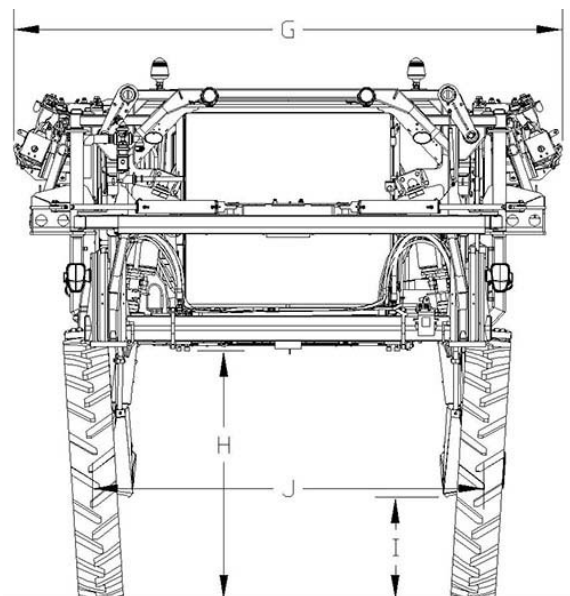

Approximate Dry Split Weights (Machine Only)	
Front	8,340 lbs./3,783 kg
Rear	15,240 lbs./6,912 kg

* Tread width is measured at half (1/2) the tire height.

** Refer to “Tire Specifications” provided elsewhere in this section for a complete listing of tire options when configuring machine specifications on your model.

General Information

NOTICE

Because Hagie Manufacturing Company offers a variety of options, the illustrations in this manual may show a machine equipped other than standard. Height and weight values may vary, depending on available equipment.

- **Frame Type:** 4 x 8” (10.2 x 20.3 cm) modular platform frame
- **Suspension:** 4-wheel, individual, auto air-ride
- **Shipping Width:**
 - 144”/365.8 cm (with 90/100’ boom)
 - 177”/449.6 cm (with 120/132’ boom)
- **Approximate Dry Weight:**
 - 23,580 lbs./10,695 kg (machine only)
 - 27,920 lbs./12,664 kg (with 90’ boom)
 - 29,440 lbs./13,353 kg (with 120’ boom)

Spray System GPS Specifications -If Equipped

NOTE: 120-ft. boom and 380/90 R54 tires used for the following machine dimensions.

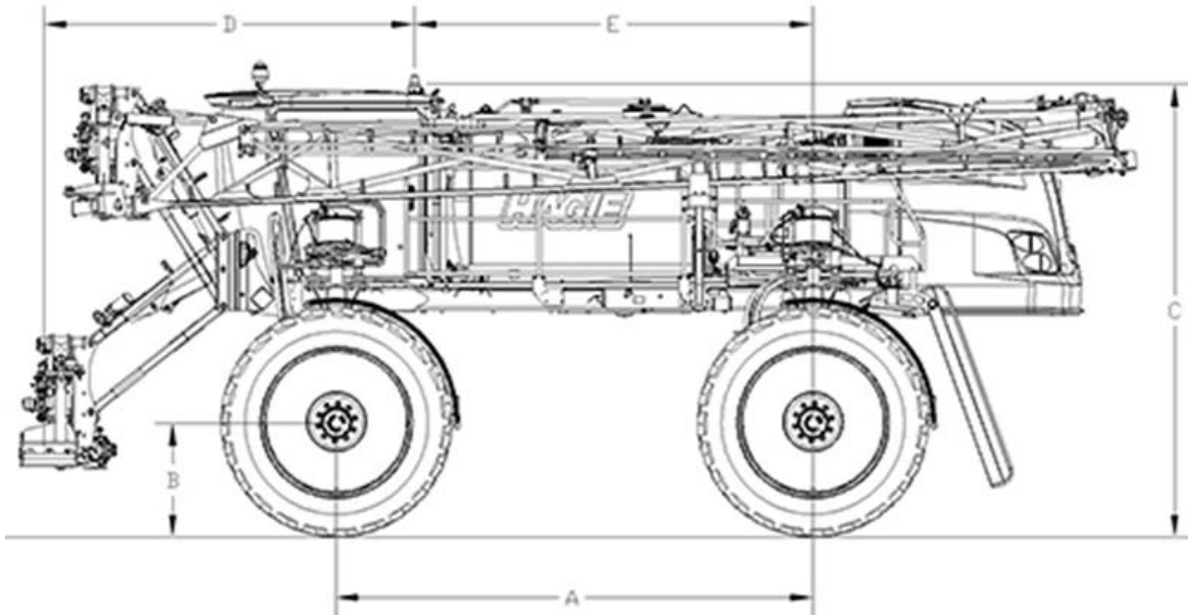

Detail	Description	Specification
A	Wheel Base	140" (355.6 cm)
B	Static Loaded Hub Height	38 3/8" (97.5 cm)
C	Overall Sprayer Height (from middle of GPS unit)	156.4" (397.3 cm)
D	Length (from front of boom spray tips to center of GPS unit)	129.8" (329.7 cm)
E	Length (from center of GPS unit to center of rear hub)	112.8" (286.5 cm)

*NOTE: Dimensions may vary depending on
boom and tire options.*



Settings and Calibration

Record settings and calibration values used in the following spaces provided when programming your spray system console. Refer to this information for future reference.

Circle the selected setting on the spray system console for the following options:

Units	• US (Acres)		• SI (Hectares)		• Turf (1,000 sq. ft./ 92 sq. m)
Speed Sensor	• SP1 (Wheel Speed)		• SP2 (Radar/GPS)		
Control Type	• Liquid Spray	• Gran 1 (Single Belt Bed)	• Gran 2 (Split Belt Bed/Single Encoder)	• Gran 3 (Split Belt Bed/Dual Encoders)	• Spinner RPM Control
Valve Type	• Standard Valve	• Fast Valve	• Fast Close Valve	• Pulse Width Modulated Valve	• Pulse Width Modulated Close Valve

Record calculated calibration values in the spaces provided below.

Speed Cal	Section Widths	Meter Cal	Rate Cal	Valve Cal	Tank Volume
1.	1.	1.	1.	1.	1.
	2.	2.	2.	2.	2.
	3.	3.	3.	3.	3.
	4.	4.	4.	4.	4.
	5.	5.	5.	5.	5.
	6.				
	7.				
	8.				
	9.				
	10.				

Description	Specification
Engine	
Manufacturer	Cummins®
Model	QSB 6.7
Type	Electronic with air-to-air cooler and turbo charger
Number of Cylinders	6
Displacement	6.7 liters (408.9 c.i.)
Horse Power	<ul style="list-style-type: none"> • Tier 4 Final - 300 hp (220.7 KW) • Tier 3 - 275 hp (202.3 KW)
Fuel Type	<ul style="list-style-type: none"> • Tier 4 Final - Ultra-low sulfur diesel (ULSD) • Tier 3 - No. 2 diesel
Fuel System	Filtered, direct-injected
Air Cleaner	Dry-type, dual element
Engine Air Filter Restriction Monitors	Filter Minder®
Slow Idle	850 RPM
Fast Idle (no load)	2300 RPM
Hydrostatic Drive	
Hydrostatic Pump	Danfoss H1-Series
Drive Train	All-Wheel 4-Wheel Drive
Speed Ranges[^]	Ranges 1-20 (operator selected)
Hydrostatic Wheel Motors	Danfoss H1-Series
Final Drives	Planetary gear reduction hubs (Bonfiglioli or Fairfield)
• Lubrication	Oil bath
Brakes (parking only)	Multiple disk, spring applied, hydraulically released
Auxiliary Hydraulic System	
Steering System	Hydraulic, priority circuit
• Control	Full-time power
• Steering Cylinders	Double acting
• Turning Radius [^]	<ul style="list-style-type: none"> • 25 ft./7.5 m (No AWS/AWS “Off”) • 18 ft./5.5 m (AWS “On”, if equipped)
All Wheel Steer (AWS), if equipped [^]	Coordinated Steering

Solution System Hydraulic Pump	Load Sense (LS) Pump
Cooling Fan Hydraulic Pump	Gear Pump
Spray System	
Booms	90/100/120/132-ft. (9 sections)
• Type	• Dry • Wet (optional)
• Controls	Electro-hydraulic (fold/lift/level)
• Level Shock Absorber	Gas charged accumulator
• 90/100-ft. Outer Boom Hydraulic Breakaway	Self-actuated, auto-reset hydraulic
• 120/132-ft. Inner Boom Breakaway	Hydraulic, manual reset
• 120/132-ft. Outer Boom Breakaway	Mechanical with spring, auto-reset
Solution Fill Connection	
• Quick-Fill Connection	3" (7.6 cm) inner diameter
Solution Tank	
• Standard	1200 gal. (4542.5 L) stainless steel
Agitation	Jet-type with electric valve variable control
General Spray System	
• Pump	Centrifugal-hydraulically driven with proportional control valve
• Solution Valves	Ball valves (manual or electric)
• Pressure Gauge	100 PSI (6.9 bar), glycerin filled
• Console	• Raven (optional) • Ag Leader® (optional)
• Fence Row Nozzle	Remote activated (left and right)
• Rear Nozzle	Remote activated
Solution Circuit Pressure	100 PSI (6.9 bar) - maximum
Foam Marking System	
Make	Richway Versa Trac
Type	Boom Mix
Rinse System	
Spray System Rinse (solution tanks, pump, and booms)	Standard
Electrical System	
General Electrical System	

• Battery	Dual 12V, negative ground (CCA)
• Alternator	200 AMP, voltage regulated
• Starter	12V with solenoid
Lights (Exterior)	
• Front of Cab	2 trapezoidal headlights, 2 floodlights, 2 rotating amber beacon lights
• Transom	2 trapezoidal headlights (if equipped)
• Transom Mount	2 trapezoidal headlights (high/low beam), 2 oval amber lights (combined)
• Boom Cradle	2 trapezoidal floodlights (1 on each cradle), 2 oval amber lights (1 on each cradle)
• Rear Engine Hood	2 round red lights, 2 round amber lights
• Spray Section Indicators (located on boom, if equipped)	1 oval white, 2 oval amber, 9 oval red
Cab and Instruments	
Sound Level (cab interior)	86 dBA (maximum)
Cab (General)	Tilt steering, wipers/washers, dual side mirrors, dome light, tinted glass, instructor seat
Temperature Control	Full range
A/C Charge Type	R-134a
Fresh Air Filtration	<ul style="list-style-type: none"> • RESPA® cab filter • Charcoal filter
Seat	Air ride
Instruments	RPM, coolant temperature, Diesel Exhaust Fluid level (if equipped), fuel level
Machine Display	Hour meter, battery voltage, engine oil pressure, ground speed, engine, tread adjustment, parking brake, machine/engine malfunction warning, engine exhaust filtration warning, high exhaust temperature warning, low hydraulic oil warning, coolant level low, low fuel level, grid heater, cab air pressure
Stereo	AM/FM Radio with CD/MP3/Bluetooth (if equipped)
Fluid Capacities	
Solution Tank	1200 gallons (4542.5 L)
Fuel Tank	135 gallons (511 L)
Engine Oil Pan (including filter and cooler)	17.6 quarts (16.7 L), SAE 15W-40
Engine Oil Dipstick (L-H mark)	2 quarts (1.9 L)

Engine Cooling System (including block, lines, and radiator)	<ul style="list-style-type: none"> • Tier 4 Final - 14 gallons (53 L), ethylene glycol • Tier 3 - 12.5 gallons (47 L), ethylene glycol
Diesel Exhaust Fluid (DEF) Tank (Tier 4 Final Engines)	10 gallons (37 L)
Hydraulic Oil (including lines, filter, cooler, etc.)	50 gallons (189 L)
Hydraulic Oil Reservoir	32 gallons (121 L)
Wheel Hubs (4)	<ul style="list-style-type: none"> • Bonfiglioli = 40 oz./each (1.18 L), 75W-90 synthetic oil • Fairfield = 62 oz./each (1.83 L), 75W-90 synthetic oil
Rinse System Tank	100 gallons (378.5 L)
Hand Wash Tank	4 gallons (15 L)
Foam Marker	3 gallons (11.4 L), foam concentrate
Detasseling System	
General	
<ul style="list-style-type: none"> • Monitors/Controls 	<ul style="list-style-type: none"> • Detasseling Control Panel • Tasselrol®/LS System 12™ Control Panel
<ul style="list-style-type: none"> • General System 	Light sensing system, depth command, electrical disconnect, hydraulic couplers
Outriggers	
<ul style="list-style-type: none"> • 12-Row 	134"/340.4 cm (1 left, 1 right)
<ul style="list-style-type: none"> • 8-Row 	75"/190.5 cm (1 left, 1 right)
Quad Pullers	
<ul style="list-style-type: none"> • Number of Rows Available 	6, 8, 10, or 12
<ul style="list-style-type: none"> • Drive 	Hydraulic
<ul style="list-style-type: none"> • Tire Size 	4.10/3.50 2-ply
<ul style="list-style-type: none"> • Tire Pressure 	10 PSI (.7 bar)
<ul style="list-style-type: none"> • Operating Speed 	Up to 400 RPM
Cutter	
<ul style="list-style-type: none"> • Number of Rows Available 	6, 8, 10, or 12
<ul style="list-style-type: none"> • Drive 	Hydraulic
<ul style="list-style-type: none"> • Blade Size 	18" (45.7 cm)
<ul style="list-style-type: none"> • Operating Speed 	Up to 3100 RPM

^ Operators with machines equipped with All-Wheel Steer (AWS) pay special attention.

TIRE SPECIFICATIONS (STANDARD)										
Size	Make	Model	Load Rating (Weight/Speed)	Air Pressure (Max PSI)	Tread Width (inches)	Load Capacity (lbs.)	Overall Diameter (inches)	Static Load Radius* (inches)	Rolling Circum. (inches)	Gross Flat Plate (in ²)
320/90R50	Goodyear®	Ultra Sprayer	161A8/B	78	12.4	10,200	73.6	33.8	219	235
320/90R50	Titan®	TT49V	161A8/B	78	12.5	10,200	72.6	34.2	220	170
320/105R54	Goodyear	Ultra Sprayer	166A8	75	13.2	11,700	80.6	37.7	242	243
380/105R50	Firestone®	9100 R1	168B	64	16	12,300	80.8	37.5	244	297
IF380/105R50	Firestone	9100 R1	177B	70	17	16,100	80.8	37	244	345
380/85R46	Goodyear	Dyna Torque	165A8	75	15.2	11,400	71.8	32.9	217	N/A
380/90R46	Goodyear	Ultra Sprayer	168A8/B	78	14.4	12,300	72.6	32.6	217	277
VF380/90R46	Michelin®	Spraybib	173D	64	15.1	14,330	72.5	33.4	217	267
380/90R46	Alliance	350	172D	84	14.9	13,880	71.8	33.1	215	N/A
380/90R54	Goodyear	Ultra Sprayer	170A8/B	75	14.3	13,200	80.9	37.5	244	305
520/85R46	Michelin	Agribib	158A8	28	20.3	10,030	80.7	36.2	240	441

TIRE SPECIFICATIONS (METRIC)										
Size	Make	Model	Load Rating (Weight/Speed)	Air Pressure (Max Bar)	Tread Width (cm)	Load Capacity (kg)	Overall Diameter (cm)	Static Load Radius* (cm)	Rolling Circum. (cm)	Gross Flat Plate (cm ²)
320/90R50	Goodyear®	Ultra Sprayer	161A8/B	5.4	31.5	4,626	186.9	85.9	556.3	1516.1
320/90R50	Titan®	TT49V	161A8/B	5.4	31.8	4,626	184.4	86.9	558.8	1096.8
320/105R54	Goodyear	Ultra Sprayer	166A8	5.2	33.5	5,307	204.7	95.8	614.7	1567.7
380/105R50	Firestone®	9100 R1	168B	4.4	40.6	5,579	205.2	95.3	619.8	1916.1
IF380/105R50	Firestone	9100 R1	177B	4.8	43.2	7,302	205.2	94	619.8	2225.8
380/85R46	Goodyear	Dyna Torque	165A8	5.2	38.6	5,170	182.4	83.6	551.2	N/A
380/90R46	Goodyear	Ultra Sprayer	168A8/B	5.4	36.6	5,579	184.4	82.8	551.2	1787.1
VF380/90R46	Michelin®	Spraybib	173D	4.4	38.4	6,500	184.2	84.8	551.2	1722.6
380/90R46	Alliance	350	172D	5.8	37.8	6,295	182.4	84.1	546.1	N/A
380/90R54	Goodyear	Ultra Sprayer	170A8/B	5.2	36.3	5,987	205.5	95.3	619.8	1967.7
520/85R46	Michelin	Agribib	158A8	1.9	51.6	4,549	205	91.9	609.6	2845.2

* Static load radius is suggested and will vary with load.

TIRE LOAD LIMITS (LBS) AT VARIOUS COLD INFLATION PRESSURES (PSI)										
	Inflation (psi)	6	9	12	15	17	20	23	26	29
320/90R50		2,270	2,760	3,200	3,640	4,080	4,540	4,940	5,200	5,520
320/90R50		2,270	2,760	3,200	3,640	4,080	4,540	4,940	5,200	5,520
320/105R54		2,680	3,200	3,740	4,300	4,800	5,360	5,840	6,150	6,400
380/105R50		3,300	3,960	4,680	5,360	6,000	6,600	7,400	7,600	8,050
IF380/105R50		3,300	4,800	5,520	6,400	7,150	8,050	8,800	9,100	9,650
380/85R46		2,680	3,200	3,740	4,300	4,800	5,360	5,840	6,150	6,400
380/90R46		2,830	3,300	3,860	4,400	5,080	5,520	6,150	6,400	6,800
VF380/90R46		N/A	N/A	N/A	N/A	N/A	N/A	N/A	N/A	9,500
380/90R46		3,280	4,620	5,430	6,240	6,500	6,950	7,300	7,770	8,180
380/90R54		3,000	3,640	4,300	4,800	5,520	6,000	6,600	6,950	7,400
520/85R46		4,610	5,510	6,420	7,320	8,220	9,130	10,030	N/A	N/A

TIRE LOAD LIMITS (LBS) AT VARIOUS COLD INFLATION PRESSURES (PSI) (CONTINUED)										
	Inflation (psi)	35	41	46	52	58	64	70	75	
320/90R50		5,840	6,400	6,950	7,400	7,850	8,550	9,100	9,650	
320/90R50		5,840	6,400	6,950	7,400	7,850	8,550	9,100	9,650	
320/105R54		6,950	7,600	8,050	8,550	9,100	9,900	10,700	11,700	
380/105R50		8,550	9,350	10,200	10,700	11,400	12,300	N/A	N/A	
IF380/105R50		10,200	11,400	12,000	12,800	13,600	14,800	16,100	N/A	
380/85R46		6,800	7,600	8,050	8,550	9,100	9,900	10,700	11,400	
380/90R46		7,150	7,850	8,550	9,100	9,650	10,500	11,400	12,000	
VF380/90R46		10,200	11,150	12,020	12,790	13,230	14,330	N/A	N/A	
380/90R46		9,000	9,780	10,530	11,250	12,500	12,940	13,400	13,880	
380/90R54		7,850	8,550	9,350	9,900	10,500	11,400	12,300	13,200	
520/85R46		N/A	N/A	N/A	N/A	N/A	N/A	N/A	N/A	

NOTE: There are no adjustments to the loads and pressures in the above table for lower speeds or stationary service.

NOTE: Minimum inflation pressures for IF agricultural tires used as singles = 12 psi.

TIRE LOAD LIMITS (KG) AT VARIOUS COLD INFLATION PRESSURES (BAR)										
	Inflation (bar)	.4	.6	.8	1.0	1.2	1.4	1.6	1.8	2.0
320/90R50		1,029	1,251	1,451	1,651	1,850	2,059	2,240	2,358	2,503
320/90R50		1,029	1,251	1,451	1,651	1,850	2,059	2,240	2,358	2,503
320/105R54		1,215	1,451	1,696	1,950	2,177	2,431	2,649	2,789	2,903
380/105R50		1,496	1,796	2,122	2,431	2,721	2,993	3,356	3,447	3,651
IF380/105R50		1,496	2,177	2,503	2,903	3,243	3,651	3,991	4,127	4,377
380/85R46		1,215	1,451	1,696	1,950	2,177	2,431	2,649	2,789	2,903
380/90R46		1,283	1,496	1,750	1,995	2,304	2,503	2,789	2,903	3,084
VF380/90R46		N/A	N/A	N/A	N/A	N/A	N/A	N/A	N/A	4,309
380/90R46		1,487	2,095	2,463	2,830	2,948	3,152	3,311	2,524	3,710
380/90R54		1,360	1,651	1,950	2,177	2,503	2,721	2,993	3,152	3,356
520/85R46		2,091	2,499	2,912	3,320	3,728	4,141	4,549	N/A	N/A

TIRE LOAD LIMITS (KG) AT VARIOUS COLD INFLATION PRESSURES (BAR) (CONTINUED)										
	Inflation (bar)	2.4	2.8	3.2	3.6	4.0	4.4	4.8	5.2	
320/90R50		2,649	2,903	3,152	3,356	3,560	3,878	4,127	4,377	
320/90R50		2,649	2,903	3,152	3,356	3,560	3,878	4,127	4,377	
320/105R54		3,152	3,447	3,651	3,878	4,127	4,490	4,853	5,307	
380/105R50		3,878	4,241	4,626	4,853	5,171	5,579	N/A	N/A	
IF380/105R50		4,626	5,171	5,443	5,806	6,169	6,713	7,302	N/A	
380/85R46		3,084	3,447	3,651	3,878	4,127	4,490	4,853	5,171	
380/90R46		3,243	3,560	3,878	4,127	4,377	4,762	5,171	5,443	
VF380/90R46		4,626	5,057	5,452	5,801	6,001	6,500	N/A	N/A	
380/90R46		4,082	4,436	4,776	5,102	5,669	5,869	6,078	6,295	
380/90R54		3,560	3,878	4,241	4,490	4,762	5,171	5,579	5,987	
520/85R46		N/A	N/A	N/A	N/A	N/A	N/A	N/A	N/A	

NOTE: There are no adjustments to the loads and pressures in the above table for lower speeds or stationary service.

NOTE: Minimum inflation pressures for IF agricultural tires used as singles = .8 bar.

2015 PRODUCT WARRANTY

Hagie Manufacturing Company Product Warranty

Hagie Manufacturing Company warrants each new Hagie product to be free under normal use and service from defects in workmanship and materials for a period of lesser of: two (2) years or 1,000 hours from the date of delivery on all Agricultural Products. Hagie Manufacturing Company makes this warranty from the original delivery date and is transferable to a purchaser from the original purchaser of this equipment, given there is remaining time left under the year and hour warranty standard stated above. This warranty shall be fulfilled by repairing or replacing free of charge any part that shows evidence of defect or improper workmanship, provided the part is returned to Hagie Manufacturing Company within thirty (30) days of the date that such defect or improper workmanship is discovered, or should have been discovered. Labor to repair said items will be covered by standard labor time rates. Freight charges of defective parts are not covered by this warranty and are the responsibility of the purchaser. No other express warranty is given and no affirmation of Hagie Manufacturing Company, by words or action, shall constitute a warranty.

Hagie Manufacturing Company limits its warranty to only those products manufactured by Hagie Manufacturing Company and does not warrant any part or component not manufactured by Hagie Manufacturing Company, such as parts or components being subject to their manufacturer's warranties, if any. Excluded from this warranty are parts subjected to accident, alteration, or negligent use or repair. This warranty does not cover normal maintenance such as engine tune ups, adjustments, inspections, nor any consumables such as tires, rubber products, solution system valves, wear parts, wiper blades, etc.

Hagie Manufacturing Company shall not be responsible for repairs or replacements which are necessitated, in whole or in part; by the use of parts not manufactured by or obtainable from Hagie Manufacturing Company nor for service performed by someone other than Hagie authorized personnel, unless authorized by Hagie Manufacturing Company. Customer acknowledges that it is not relying on Hagie Manufacturing Company's skill or judgment to select finish goods for any purpose and that there are no warranties which are not contained in this agreement.

In no event shall Hagie Manufacturing Company's tort, contract, or warranty liability exceed the purchase price of the product. The foregoing limitation will not apply to claims for personal injury caused solely by Hagie Manufacturing Company's negligence.

Hagie Manufacturing Company shall not be liable for damages, including special, incidental or consequential damages or injuries (damage and repairs of equipment itself, loss of profits, rental or substitute equipment, loss of good will, etc.) arising out of or in connection with performance of the equipment or its use by customer, and Hagie Manufacturing Company shall not be liable for any special, incidental or consequential damages arising out of or in connection with Hagie Manufacturing Company's failure to perform its obligation hereunder. HAGIE MANUFACTURING COMPANY'S ENTIRE LIABILITY AND THE CUSTOMER'S EXCLUSIVE REMEDY SHALL BE REPAIR OR REPLACEMENT OF PARTS COVERED UNDER THIS WARRANTY. THIS WARRANTY IN LIEU OF ALL OTHER WARRANTIES, EXPRESSED OR IMPLIED, INCLUDING, BUT NOT LIMITED TO THE IMPLIED WARRANTY OF MERCHANTABILITY OR FITNESS FOR A PARTICULAR PURPOSE.

Emissions Limited Warranty

The following emissions components are covered under a 5 year/3,000 hour limited warranty. Some of the components listed may be covered under the manufacturer's limited warranty.

Air Handling System and Associated Plumbing

- Charge Air Cooler
- Charge Air Cooler Plumbing
- Charge Air Temperature Sensor

Engine Electronic Components

- Wire harness circuits connected at both ends to emissions warrantable components

Exhaust System (upstream of last Aftertreatment)

- Exhaust gas piping from turbocharger out to the last Aftertreatment device

Exhaust Aftertreatment

- Urea Quality Sensor
- Urea Level Sensor
- Urea Tank and Lines
- Urea Tank/Line Heating Elements or Heater Exchanger and Pipe
- Urea Temperature Sensors
- Tank Heater Coolant Control Valve
- Line Heater Control Relay

Vehicle Electronic Components

- On Board Diagnostic (OBD) Malfunction Indicator Lamp (MIL)
- Diesel Exhaust Fluid (DEF) Indicator Lamp

Refer to the engine operator's manual (Section W) for detailed information on products warranted, coverage, and limitations under the engine manufacturer's warranty.

SECTION 2 – SAFETY AND PRECAUTIONS

INTENDED USE

NOTICE

This machine is designed for and intended to be used for the application of chemicals and fertilizers to field crops, as well as the removal of tassels from the tops of corn plants. Use in any other way or for any other purpose is considered misuse of this machine.

Most accidents occur as the result of failure to follow basic and fundamental safety rules and precautions. Recognizing potential safety hazards, following correct and safe operating procedures described in this manual, and complying with safety warnings located throughout the machine may reduce the risk of accidents.

There is no way to completely eliminate the potential for danger when operating agricultural equipment. Therefore, you must study this operator's manual and understand how to operate the sprayer controls for safe operation before using the sprayer, its attachment, or any sprayer equipment. Likewise, never let anyone operate the machine without proper instruction.

Do not operate the sprayer, its attachment, or any sprayer equipment for anything other than their intended uses. Hagie Manufacturing Company shall not be liable for any damage, injury, or death associated with improper use of the sprayer, its attachment, or any sprayer equipment.

Do not make any modifications such as, but not limited to, weldments, add-ons, adaptations, or changes from the original design of the sprayer. Such modifications may become safety hazards to you and others and **will void all warranties.**

Replace missing, faded, or damaged safety signs. Refer to "Safety Decals" elsewhere in this section for correct sign and placement.

SAFETY PRECAUTIONS

NOTE: If your machine is equipped with All Wheel Steer (AWS), pay special attention to components, operating instructions, and safety precautions marked with ^.

Do Not Bypass Safety Start

- Start the machine from the operator's seat only.
- The parking brake must be engaged before starting the engine.



Use Caution While Driving ^

- Never drive near ditches, embankments, holes, mounds, or other obstacles.
- Never drive on hills too steep for safe operation.



- Reduce machine speed before turning.

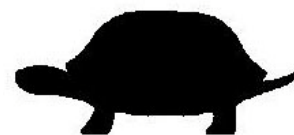

- Do not permit passengers to ride on the machine while it is moving. Failure to com-

ply may result in passenger falling off of machine and/or obstructing the operator's view.



- Ensure there is adequate clearance before driving under any overhead obstructions. Contact with power lines may result in serious injury or death.



- Booms must be folded and in cradles when driving the machine on a roadway or when near power lines.

Keep Riders Off Machine

- Do not permit passengers to ride on the machine or in the cab. The only time a passenger should be permitted to ride inside the cab is for instructional or diagnostic purposes only. The passenger should be seated in the Instructor Seat next to the operator and never allowed to ride outside of the cab.

Remove Paint Before Welding or Heating

- Avoid toxic fumes and dust. Hazardous fumes can be generated when paint is heated by welding, soldering, or using a torch.



- Do not use chlorinated solvents in areas where welding will take place.
- Perform all work in an area that is well ventilated to carry toxic fumes and dust away.
- Dispose of paint and solvents properly.

Avoid Heating Near Pressurized Lines

- Avoid torching, welding, and soldering near pressurized hydraulic lines. Pressurized lines may accidentally burst when heat goes beyond the immediate flame area.



Handle Fuel Safely

- Always turn the engine off and allow it to cool before refueling.
- NEVER smoke while refueling.



- Do not fill tank completely, as fuel may expand and run over.
- Always clean up spilled fuel with soapy water.
- Keep a fire extinguisher nearby when refueling.

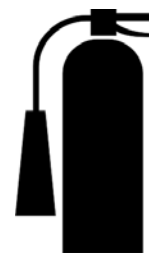

Operate Safely ^

- Before moving the machine, ensure there are no obstacles or persons in the path of travel.
- Never operate a machine in the same field as walking personnel.
- Always drive at a reasonable field speed.
- Never operate the machine on a roadway with solution in the tank. Additional weight caused from a full or partially full solution tank may cause erratic or increased stopping distance.
- Do not operate the machine at speeds exceeding 20 mph (32 km/h) with solution in the tank. Operating speeds exceeding 20 mph (32 km/h) with a fully loaded tank may result in tire blow-out or wheel hub damage and will void the warranty.
- Ensure the Slow Moving Vehicle (SMV) emblem and the Speed Indicator Symbol (SIS) are in place and visible from the rear of machine when traveling on public roadways.



SMV



SIS (mph)



SIS (km/h)

- Pull over to the side of the road before stopping.
- Always come to a complete stop before reversing directions.
- Keep a fire extinguisher nearby at all times.
- Keep ALL shields in place.
- Keep clear of all moving parts and keep others away while operating (including the reversible fan).
- Do not wear loose fitting clothing that may be blown or drawn into moving parts.
- Do not activate the parking brake while the machine is in motion.

- Bring machine to a gradual stop to avoid sudden downward decent.
- Reduce speed for icy, wet, graveled, or soft roadway surfaces.
- Use flashers/hazard warning lights (day or night) unless prohibited by law.
- Keep away from overhead power lines. Serious injury or death may result to you or others should the machine come into contact with electrical power lines.
- Never unfold/fold boom extension while the main boom is in the cradle.
- Never operate the sprayer with one boom out of the cradle, and the other boom in the cradle.
- Never use starting fluid to assist engine start-up.
- If your machine is equipped with ground speed sensing radar or light sensing depth units, do NOT look directly into radar beam, as it emits a very low intensity microwave signal, which may result in possible eye damage.

Be Prepared

- Be prepared for an emergency. Keep a fire extinguisher, first aid kit, and clean water in the cab at all times.
- Service the fire extinguisher regularly.
- Keep an accurate inventory of supplies in the first aid kit and dispose of any item(s) that have expired.

Wear Protective Clothing

- Do not wear loose fitting clothing that could get caught in moving parts. Wear safety equipment that is appropriate for the job.



- Do not store chemical-soaked clothing in the cab. Clean off as much mud and dirt from your shoes as you can before entering the cab.

Protect Against Noise

- Operating equipment safely requires full attention of the operator. Do not wear radio or music headphones while operating the machine.
- Wear suitable hearing protection. Prolonged exposure to loud noise may result in loss of hearing.



Battery Acid Accident Prevention

Avoid serious injury by avoiding battery acid contact with your body. Battery electrolyte contains sulfuric acid that is strong enough to eat holes in clothing and cause blindness if splashed into eyes.

Make sure to:

- Fill batteries in a well ventilated area.
- Wear Personal Protective Equipment (PPE) when servicing a battery.
- Avoid inhaling of fumes when recharging with electrolyte.
- Avoid spilling or dripping electrolyte.
- When charging a battery, connect positive cable to positive terminal and negative cable to negative terminal. Failure to comply may result in an explosion and/or personal injury.

If you spill on yourself:

- Flush affected area with cold water and remove contaminated clothing and shoes immediately. Continue to flush the area for a minimum of 15 minutes.



- Call a physician.
- While transporting or waiting for medical attention, apply compresses of iced water or immerse affected area in iced water. **DO NOT ALLOW TISSUE TO FREEZE.**
- Do not apply creams or ointments until you have been seen by a physician.

If acid is swallowed:

- Do NOT induce vomiting.
- Drink large amounts of water.
- Seek medical attention immediately!
- Do not neutralize the acid.

If fumes are inhaled:

- Move the person into fresh air.
- Do not give artificial respiration to a person that is able to breath on their own.
- Give CPR only if there is no breathing and no pulse.
- Seek medical attention immediately!

Handle Agricultural Chemicals Safely

Agricultural chemicals used in applications can be harmful to your health and the environment if not used properly.

- Always follow the manufacturer's label for directions of use.
- Never allow chemicals to come in contact with your skin or eyes. Always use the proper Personal Protective Equipment (PPE).
- Never pour chemicals into an empty tank. Always fill tank half full of water first.
- Dispose of empty chemical containers properly.



- Wash spilled chemicals or spray residue from the sprayer to prevent corrosion and deterioration.
- Select safe areas to fill, flush, calibrate, and clean the sprayer where chemicals will not run off to contaminate people, animals, vegetation, or water supply.
- Never place a spray tip/nozzle to your mouth in an attempt to unplug it.
- Do not spray when wind is in excess of chemical manufacturer's recommendation.
- Store chemicals in their original containers with the label intact.
- Store chemicals in a separate, locked building.
- Wear Personal Protective Equipment (PPE) as recommended by the chemical manufacturer.

Safe Hydraulic Maintenance

- Always practice personal safety when performing service or maintenance on the hydraulic system.
- Use caution when working around hydraulic fluid under pressure. Escaping fluid can have sufficient force to penetrate your skin, possibly resulting in serious injury. This fluid may also be hot enough to burn.

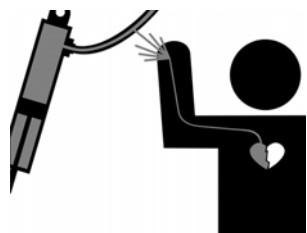

- Always lower the load or relieve the pressure before repairing a hydraulic oil leak.

Beware of Exhaust Fumes

- Never run the machine in an enclosed area. Proper ventilation is required. Use an exhaust pipe extension to remove fumes if you must operate inside a building. Also, open doors and windows to bring in enough outside air into the area.

General Maintenance Safety

- Turn off engine before checking, adjusting, repairing, lubricating, or cleaning any part of the sprayer.
- Remove all chemical residue from the work area before performing service/maintenance.
- When servicing the radiator, allow engine to cool before removing the pressurized cap.



- Disconnect battery ground cable and turn the Battery Disconnect Switch OFF before servicing the electrical system or welding on the machine.



- Machines equipped with All Wheel Steer (AWS) have position sensing internal to the steering cylinders. Disconnect each sensor before welding on the machine. ^

Spray Booms

- Select a safe area before unfolding/folding the booms.
- Clear area of personnel.
- Cradle booms when leaving the sprayer unattended.
- Ensure booms are folded when cradled.
- Do not unfold boom extension when main boom is in the cradle.
- Do not operate the sprayer with one boom out of cradle and other boom in cradle.
- Check for overhead obstructions.
- Do not unfold or fold booms near power lines. **Contact with power lines can result in serious injury or death.**

A warning message will appear on the Machine Display before extending the outer boom extensions or when operating in Auto Fold. Press ACKNOWLEDGE showing that you have acknowledged that there are no overhead power lines or obstructions before proceeding.

120/132' Spray Booms

Before initial use, install provided boom hose clamps before unfolding the boom. Failure to comply may result in property damage.

Refer to “Spray Boom Hose Clamp Installation” provided in *Section 7 - Spray Systems* elsewhere in this manual for further information.

Cold Oil Scenarios

- If the oil temperature is less than 50°F, the operator may experience control loss on the 90-ft. and 100-ft. fold cylinders. These cylinders are the main cylinders affected by over-running loads due to the weight rotation of the boom during unfold/fold situations. When the oil is cold, the valve response is not as fast or accurate. Therefore, when having to lift the weight, the cylinder will move slower, but in trying to suspend the weight, the weight may cause faster movement, as the valve is

not dampening the flow like it normally would.

NOTE: This situation requires the operator to ensure no one is near the boom during operation.

All Wheel Steer (AWS) Safety ^

–If Equipped

Many of the following precautions are repetitious to the precautions for a standard machine. It is imperative they receive special consideration. Failure to comply with the AWS safety precautions and operating instructions may result in property damage, serious injury, or death.

- Become familiar with and understand how to operate your machine in conventional steering mode before operating with AWS.
- Understand AWS system components, operating procedures, and system limitations before operating.
- Reduce machine speed before turning.
- Never drive on hills too steep for safe operation.
- Never drive near ditches, embankments, holes, mounds, or other obstacles.
- Come to a complete stop before reversing directions.
- Always drive at a reasonable field speed.

SEAT BELT

For your safety, it is recommended that you wear your seat belt at all times when operating the machine.

Seat Belt Operation

- Grasp the Seat Belt Buckle (located on the outward side of seat) and extend all the way across your hips, seated below your abdomen.
- Insert the buckle tongue into the receptacle assembly (located on the opposite side of seat) and engage into LOCKED position.

- **To release Seat Belt**, press the Release Button (located on the receptacle end) and allow belt to retract.

ROTATING BEACONS

The Rotating Beacons (located on each side of the cab) are used for increased visibility to others. The beacons will illuminate when the Hazard/Warning Lights Switch (located on the steering column) is activated.

NOTE: The Rotating Beacons are active in both Road and Field mode. The Hazard/Warning Lights are active in Road mode only.



Rotating Beacon
(Located on each side of the cab)
-Typical View

EMERGENCY STOP (E-Stop)

NOTICE

Do not use the E-Stop Switch for non-emergency stopping or as a parking brake.

The E-Stop Switch (located on the side console) provides a quick and positive method for stopping the engine in an emergency situation.

When the E-Stop Switch is depressed, it locks in position and removes the ignition signal to shut down the engine. To reset the E-Stop Switch, turn the switch in the direction of the arrows (located on the face of the button).



E-Stop Switch
(Located on the side console)
-Typical View

When the E-Stop Switch is activated, a message will appear on the Machine Display to alert the operator that the E-Stop is engaged. Press OK to acknowledge.



E-Stop Active Message
(Located on the Machine Display)

OPERATOR PRESENCE SWITCH (OPS)

The Operator Presence Switch (located inside the operator’s seat) protects the operator from exposure to moving parts or hazards when operating the detasseler cutter heads and quad pullers.

This safety feature introduces an electrical interlock that ensures that when the operator is out of the cab, the operation of these functions have stopped. This is achieved by using the OPS to prevent the detasseler assemblies from operating if the operator is not seated in the operator’s seat for three (3) seconds.



Operator Presence Switch
(Located inside the operator’s seat)
-Typical View

When the operator leaves the operator’s seat while the machine is running, a warning message will appear on the Machine Display to alert the operator to operate the machine from seat. Press OK to acknowledge.

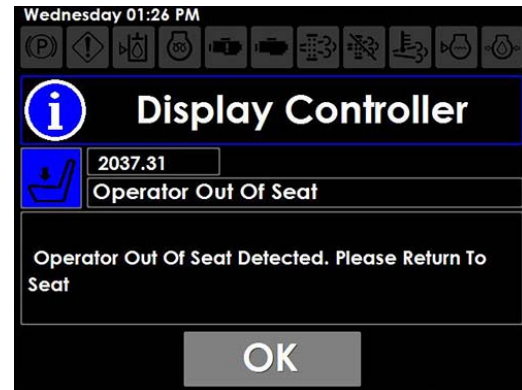

Operator Out Of Seat Message
(Located on the Machine Display)

EMERGENCY EXIT

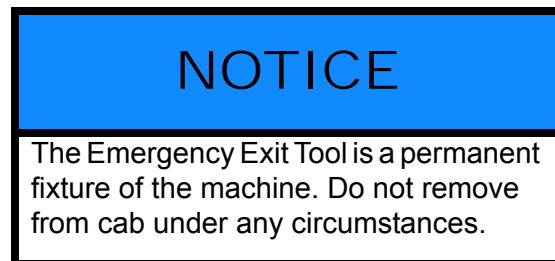
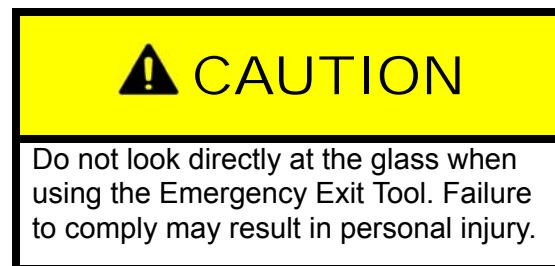

In the event of an emergency, use the cab door to exit the machine. Should the cab door become inoperable, an Emergency Exit Tool (located along the rear right-hand side of cab) is provided and is used in the rare event to shatter the glass of the cab.

- Using the metal end of the Emergency Exit Tool, repeatedly strike the glass to shatter.



Emergency Exit Tool
(Located along rear right-hand side of cab)
-Typical View

Should the need arise to escape from a seat belt that may become inoperable, use the “hook end” of the Emergency Exit Tool to cut the seat belt.

FIRE EXTINGUISHER

Your machine is equipped with a Fire Extinguisher (located along the platform on the left-hand side of machine). In the event that use of the Fire Extinguisher is required, follow the manufacturer’s operating instructions provided on the Fire Extinguisher.

To Remove Fire Extinguisher

- Pull the Security Latch **OUTWARD** to disengage and remove Fire Extinguisher.



Fire Extinguisher
(Located along the platform
on left-hand side of machine)
-Typical View

Inspection and Replacement

Follow the manufacturer’s recommendations on inspection and replacement.

FIRST AID KIT

A First Aid Kit (located beneath the operator’s seat) is provided for your convenience.

NOTE: Keep an accurate inventory of supplies in the First Aid Kit and dispose of any item(s) that have expired.



First Aid Kit
(Located beneath the operator’s seat)
-Typical View

ROLL-OVER PROTECTION STRUCTURE (ROPS)

The cab on your machine is featured with a Roll-Over Protection Structure (ROPS), which is intended to protect the operator from injuries caused by machine rollovers.

The following ROPS certification decal (located inside cab on the rear right-hand b-post) indicates that your cab has met specific testing requirements and is compliant with Occupational Safety and Health Administration (OSHA) and International Organization for Standardization (ISO) regulations.

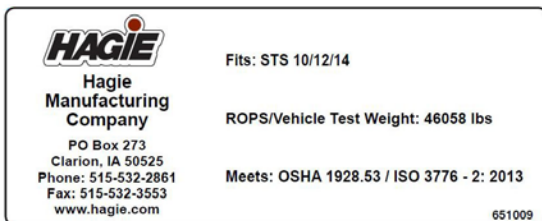

ROPS Certification Decal
(Located inside cab on
the rear right-hand b-post)

NOTE: The ROPS/Vehicle Test Weight listed on the certification decal is the maximum overall weight (including machine, solution, and attachment) allowed to be compliant with ROPS testing.

NOTE: The ROPS is non-compliant with use of the 60-ft. Nitrogen Tool Bar.

NOTICE

The addition of optional equipment on your machine may increase the ROPS maximum overall weight. If this weight exceeds the vehicle test weight, the ROPS becomes non-compliant.

ROPS Inspection Guide

ROPS, like any other safety device, need to be periodically inspected to verify that the integrity of the device has not been compromised through normal machine use, misuse, age degradation, modifications, or roll-overs.

Some mechanical discretion is essential. Therefore, personnel who inspect ROPS need to comprehend and understand the significance of issues like - if in doubt, remove the machine from service and contact the ROPS manufacturer for assistance. Certain conditions will absolutely render the ROPS unusable. Such examples are:

- Permanent deformation or twisting
- Missing, damaged, or loose mounting hardware
- Heavily weathered or torn rubber isolators
- Mounting hardware that is of a grade lesser than specified
- Any cracks in the structure (structural members and/or welds)
- Significant corrosion
- Modifications (i.e. unauthorized welds and or/holes)
- Missing or unreadable ROPS label
- Applicable ROPS machine model not specified on the ROPS label
- Missing seat belts
- Any unauthorized repair
- Incomplete/improper installation

Other conditions may require imminent service, but may not render the unit immediately unusable. Such examples are:

- Faded paint
- Slightly weathered isolators
- Faded, hard to read ROPS label
- Significantly corroded mounting hardware

ROPS must be inspected immediately after any type of collision, roll-over, or impact. If any damage is evident, the ROPS must be removed from service, repaired, and/or replaced.

When a ROPS is removed or reinstalled, mounting hardware must be examined for signs of over-stressing. Damaged mounting hardware must be replaced with proper specification hardware before placing the ROPS back in service.

Properly maintained seat belts are essential to compliment the operator crush protection designed into the ROPS. All seat belt and/or seat belt anchorage systems that show evidence of cuts, fraying or wear, significant discolorations due to exposure to the elements, heavily soiled - especially with oil grease or fuel, or any type of damage must be immediately replaced, regardless of age.

Operators are to be instructed to properly adjust and use seat belts at all times.

SAFETY DECALS

Safety decals warning you of avoidable danger are located on various parts of the machine and attachment. They are there for your personal safety and protection. DO NOT remove them. They will fracture upon attempted removal and therefore, must be replaced.

Following are locations of important safety decals. Replace them if they are damaged or missing. All safety decals, instructional decals, or machine striping may be purchased through Hagie Customer Support.

To replace safety decals, ensure the installation area is clean and dry and decide on exact position before you remove the backing paper.

Safety Decal Locations

650164

(Located on rear left-hand cab post)



650174

(Located on top of radiator)

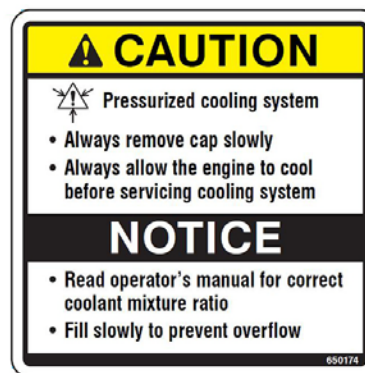

650176
(Located on rear right-hand cab post)



650218
(2) - One located on each end of combo attachment

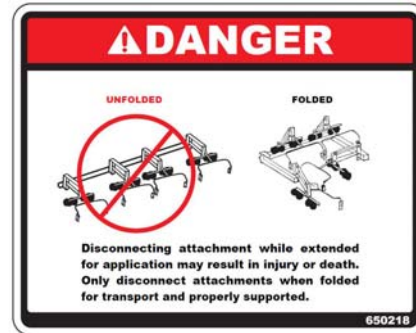

650258
(Located on each side of the cutter head assemblies)

650178
(2) - Quick-Tach

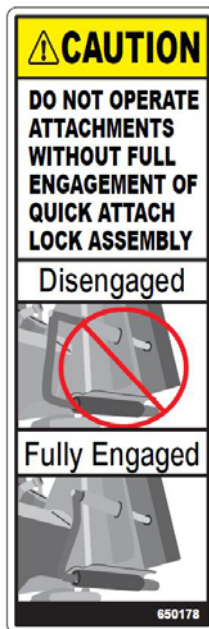

CAUTION



SEVERING OF FINGERS OR HAND.
DO NOT PLACE FINGERS OR HAND NEAR A MOVING CUTTER BLADE, ATTEMPT TO STOP A MOVING CUTTER BLADE, OR PERFORM MAINTENANCE NEAR A MOVING CUTTER BLADE.

650259
(Located on mounting tube of each quad puller head assembly)



RISK OF INJURY FROM ROTATING TIRES. DO NOT PLACE FINGERS OR HAND NEAR MOVING QUAD PULLER TIRES, DISLodge A WEDGED OBJECT FROM MOVING TIRES, OR PERFORM MAINTENANCE NEAR MOVING TIRES.

650277
(4) - Located near each lifting point containment ring



RISK OF INJURY DUE TO IMPROPER LIFTING. DO NOT ATTEMPT TO LIFT MACHINE WITHOUT JACKS PROPERLY SEATED IN THE LIFTING POINT CONTAINMENT RINGS.

650295
(Located on rear frame around booster terminals)

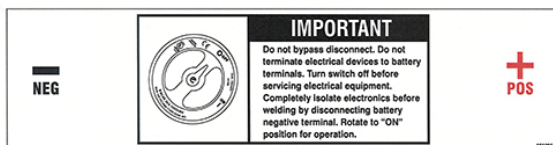

650296
(Located on rear frame near booster terminals)

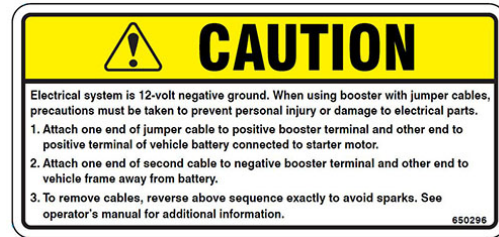

650303
(Located on right-hand cab window)

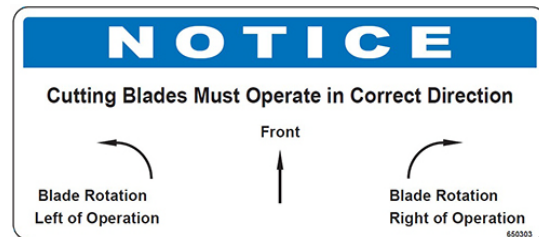

650339
(Located on front cross member)

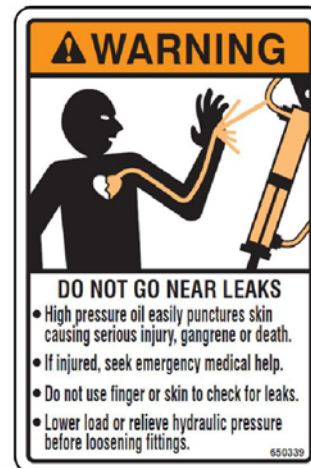

650348
(Located on air tank)



650379
(Located on right-hand cab window)

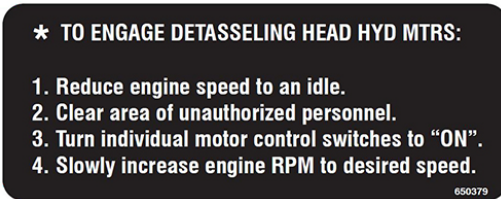

650401
(Located near side-fill and front-fill)

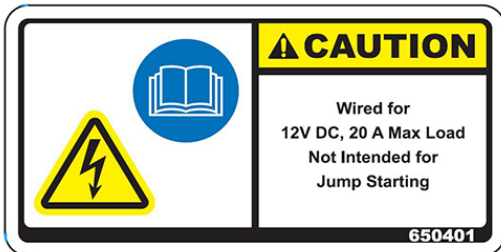

650430
(Located on the hydraulic oil reservoir)

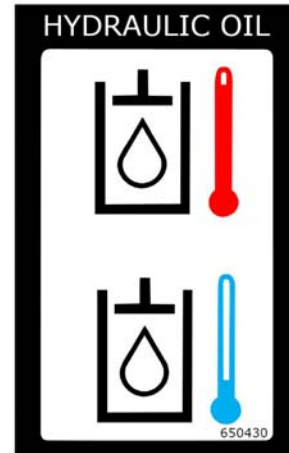

650431
(Located near the fuel fill - Tier 4 engines only)



650434
(Located near reversible fan)



CUTTING/SEVERING OF FINGERS OR HAND.
DO NOT PLACE FINGERS OR
HAND NEAR MOVING FAN BLADES.

650462
(Located near radiator cap)

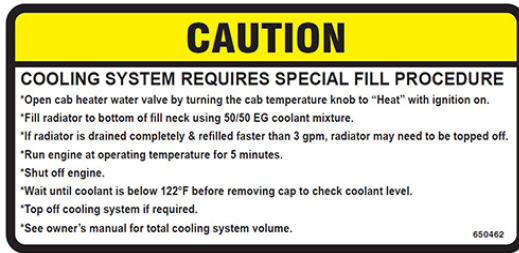

650474
(Located on rear right-hand cab post)



READ OPERATOR’S MANUAL.
REMOVE KEY AND READ MAINTENANCE
SECTION OF OPERATOR’S MANUAL
BEFORE SERVICING.

650541
(Located near solution tank opening)

⚠ DANGER



NEVER ENTER SOLUTION
TANK WITH WHOLE BODY.
FAILURE TO COMPLY WILL RESULT
IN SERIOUS INJURY OR DEATH.

650542
(Located near charge ports beneath
machine)

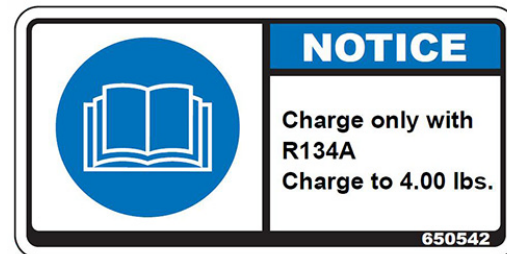

650849
(Located near fuel cap)

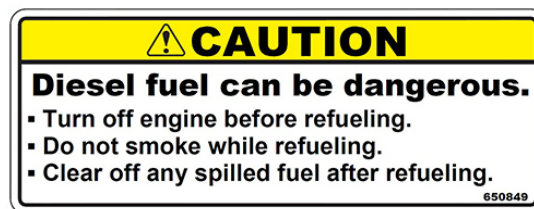

650850

- Front Fill: Located on solution tank near fill lid
- Side Fill: Located on inductor tank lid



650851

- (Located on underside of belly shields)



90/100' Boom Decals

650203

- (Located on transom)



650204

- (4) - Located near each fold point



650208

- (Located on transom)



650210

- (3) - Located on each NORAC® sensor



120/132' Boom Decals

650203

- (Located on fixed transom)



650204

- (6) - Located near each fold point



650208
(Located on fixed transom)



650249



READ OPERATOR'S MANUAL

650210
(5) - Located on each NORAC sensor



650250



WEAR EYE PROTECTION

650390
(2) - Located on cylinder near accumulator



650251

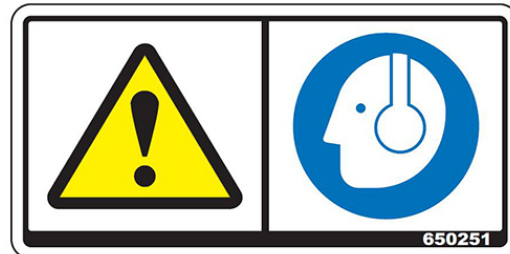

WEAR EAR PROTECTION

CE Supplement
(Export Machines)

650248

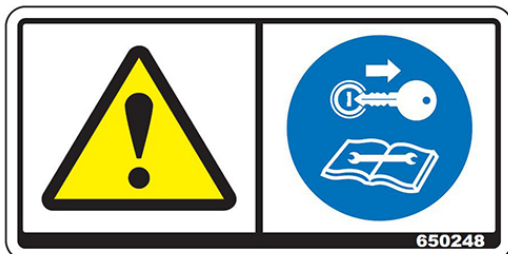

REMOVE KEY AND READ MAINTENANCE
SECTION OF OPERATOR'S MANUAL

650252

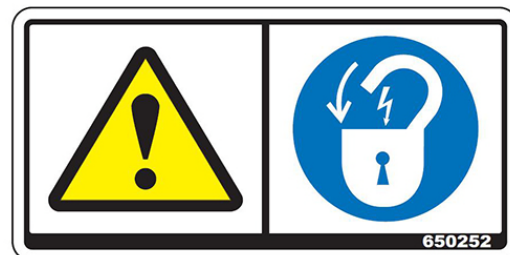

ELECTRICAL LOCK-OUT

650255

HOT SURFACE.
DO NOT TOUCH EXHAUST TUBE WHILE ENGINE
IS RUNNING. ALLOW ADEQUATE TIME FOR THE
ENGINE TO COOL DOWN BEFORE SERVICING.

650256

PRESSURIZED FLUID OR GAS.
KEEP SAFE DISTANCE AWAY FROM HAZARD.

SEAT - OPERATOR (DELUXE)

- (A) - Armrest Height Adjuster
- (B) - Armrest Tilt Dial
- (C) - Fore/Aft Isolation Lever
- (D) - Recline Lever
- (E) - Slide Release Lever
- (F) - Thigh Tilt Lever
- (G) - Height Adjustment Lever
- (H) - Thigh Extension Lever

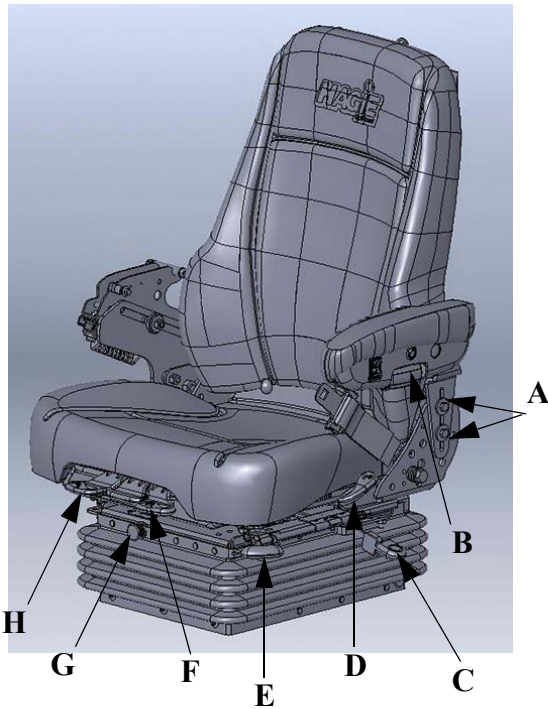

- (I) - Armrest Height/Length Adjuster
- (J) - Lumbar Knob
- (K) - Document Pouch

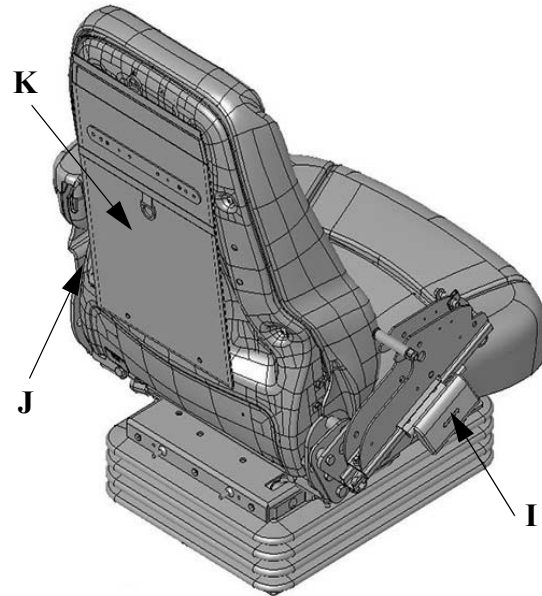

Armrest Height Adjuster (A)

(Adjusts armrest height)

- Loosen two (2) bolts and move armrests up or down.
- While maintaining desired armrest position, re-tighten bolts.

Armrest Tilt Dial (B)

(Tilts armrests)

- Roll Armrest Tilt Dial (located on side of operator's seat) INWARD (towards operator) to tilt armrest DOWN.
- Roll Armrest Tilt Dial OUTWARD (away from operator) to tilt armrest UP.

Fore/Aft Isolation Lever (C)

(Locks or unlocks fore/aft isolation)

- Pull Fore/Aft Isolation Lever UP to unlock isolation.
- Push Fore/Aft Isolation Lever DOWN to lock isolation.

Recline Lever (D)

(Angles back rest cushion)

- Pull and hold Recline Lever UP to adjust back rest angle. Release lever when desired angle is achieved.

Slide Release Lever (E)

(Moves top of seat fore/aft)

- Pull and hold Slide Release Lever while sliding seat forward or rearward. Release lever when desired position is achieved.

Thigh Tilt Lever (F)

(Tilts seat cushion up and down)

- Pull Thigh Tilt Lever UP and hold cushion to adjust + 4 degrees. Release lever when desired position is achieved.
- Pull Thigh Tilt Lever UP and push cushion down to adjust -4 degrees. Release lever when desired position is achieved.

Height Adjustment Lever (G)

(Moves seat up and down)

- Push Height Adjustment Lever IN to increase seat height.
- Pull Height Adjustment Lever OUT to decrease seat height.

Thigh Extension Lever (H)

(Extends seat cushion fore/aft)

- Pull Thigh Extension Lever UP and hold to adjust cushion +/- 30 mm. Release lever when desired position is achieved.

Armrest Height/Length Adjuster (I)

(Adjusts height and length of armrest)

- Pull and hold Armrest Height/Length Adjuster and slide forward or rearward. Release adjuster when armrest is in desired position.

Lumbar Knob (J)

(Adjusts lumbar curvature)

- Rotate Lumbar Knob INWARD (toward operator) for increased curve.
- Rotate Lumbar Knob OUTWARD (away from operator) for decreased curve.

Document Pouch (K)

(Storage for various machine manuals)

- Pull Document Pouch Fastener to OPEN.
- Push Document Pouch Fastener to CLOSE.

Seat Belt

Refer to “Seat Belt” provided in the *Safety and Precautions Section* elsewhere in this manual for further information.

SEAT - OPERATOR (PREMIUM)

-If Equipped

Your machine may be equipped with a Premium Air Ride Operator’s Seat that is equipped with the following features for your driving and comfort needs.

- (A) - Headrest
- (B) - Heat/Cool Selector Switch
- (C) - Heat/Cool Temperature Switch
- (D) - Armrest Tilt Dial
- (E) - Height Adjustment Switch
- (F) - Recline Lever
- (G) - Slide Release Lever
- (H) - Thigh Tilt Lever
- (I) - Thigh Extension Lever

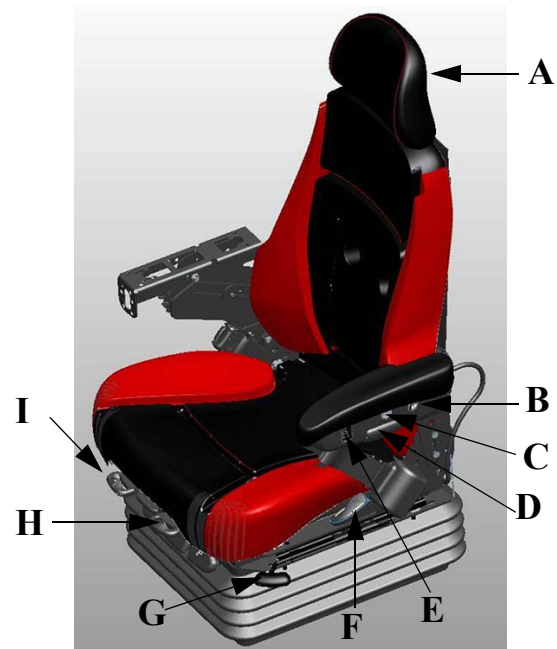

- (J) - Armrest Height Adjuster
- (K) - Fore/Aft Lockout Isolator
- (L) - Lateral Lockout Isolator
- (M) - Ride Firmness Lever



- (N) - Armrest Height/Length Adjuster
- (O) - Lumbar Knob
- (P) - Document Pouch

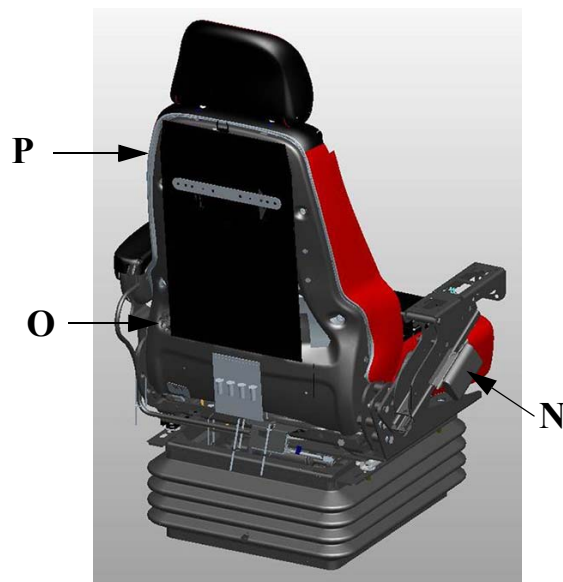

Headrest (A)

(Adjusts height and tilt)

- Firmly grasp headrest and pull UP for higher adjustment.
- Firmly grasp headrest and push DOWN for lower adjustment.

Tilt:

(*First Position: hold and rotate down 10-degrees; Second Position: hold and rotate down 20-degrees; Third Position: hold and rotate down 30-degrees. Hold and rotate down to return Headrest to 0-degree position.*)

Heat/Cool Selector Switch (B)

(Selects between heat and cool settings)

- Press Heat/Cool Selector Switch FORWARD to cool.
- Press Heat/Cool Selector Switch REARWARD to heat.

Heat/Cool Temperature Switch (C)

(Switches heat/cool temperature to high, low, or off settings)

- Press Heat/Cool Temperature Switch UP for HIGH heat or cool.
- Press Heat/Cool Temperature Switch DOWN for LOW heat or cool.
- Press Heat/Cool Temperature Switch to the MID position to turn OFF.

Armrest Tilt Dial (D)

(Tilts armrests)

- Roll Armrest Tilt Dial (located on each side of operator's seat) INWARD (towards operator) to tilt armrest DOWN.
- Roll Armrest Tilt Dial OUTWARD (away from operator) to tilt armrest UP.

Height Adjustment Switch (E)

(Moves seat up and down)

- Press Height Adjustment Switch UP to increase seat height.
- Press Height Adjustment Switch DOWN to decrease seat height.

Recline Lever (F)

(Angles back rest cushion)

- Pull and hold Recline Lever UP to adjust back rest angle. Release lever when desired angle is achieved.

Slide Release Lever (G)**(Moves top of seat fore/aft)**

- Pull and hold Slide Release Lever while sliding seat forward or rearward. Release lever when desired position is achieved.

Thigh Tilt Lever (H)**(Tilts seat cushion up and down)**

- Pull Thigh Tilt Lever UP and hold cushion to adjust +4 degrees. Release lever when desired position is achieved.
- Pull Thigh Tilt Lever UP and push cushion down to adjust -4 degrees. Release lever when desired position is achieved.

Thigh Extension Lever (I)**(Extends seat cushion fore/aft)**

- Pull Thigh Extension Lever UP and hold to adjust cushion +/- 30 mm. Release lever when desired position is achieved.

Armrest Height Adjuster (J)**(Adjusts armrest height)**

- Loosen two (2) bolts and move armrests up or down.
- While maintaining desired armrest position, re-tighten bolts.

Fore/Aft Lockout Isolator (K)**(Locks or unlocks fore/aft isolation)**

- Pull Fore/Aft Lockout Isolator UP to unlock isolation.
- Push Fore/Aft Lockout Isolator DOWN to lock isolation.

Lateral Lockout Isolator (L)**(Locks or unlocks lateral isolation)**

- Pull Lateral Lockout Isolator UP to lock isolation.
- Push Lateral Lockout Isolator DOWN to unlock isolation.

Ride Firmness Lever (M)**(Adjusts ride suspension)**

- Pull Ride Firmness Lever UP for a firmer ride.
- Push Ride Firmness Lever DOWN for a softer ride.

Armrest Height/Length Adjuster (N)**(Adjusts height and length of armrest)**

- Pull and hold Armrest Height/Length Adjuster and slide forward or rearward. Release adjuster when armrest is in desired position.

(Fore/Aft Adjustment: +/- 76 mm at 12.7 mm increments; Up/Down Adjustment: +/- 35 mm at 5.4 mm increments)

NOTE: Armrest tilt fixed position = 25 degrees.

Lumbar Knob (O)**(Adjusts lumbar curvature)**

- Rotate Lumbar Knob INWARD (toward operator) for increased curve.
- Rotate Lumbar Knob OUTWARD (away from operator) for decreased curve.

Document Pouch (P)**(Storage for various machine manuals)**

- Pull Document Pouch Fastener to OPEN.
- Push Document Pouch Fastener to CLOSE.

Seat Belt

Refer to “Seat Belt” provided in the *Safety and Precautions Section* elsewhere in this manual for further information.

SEAT - INSTRUCTOR

The cab area is featured with an Instructor Seat to allow a passenger to be seated and instructed on how to operate the machine.



Instructor Seat
-Typical View

A storage compartment and cup holders are located beneath the Instructor Seat for your convenience. Lift hinged seat to access.



-Typical View

- (I) - Steering Column Tilt Adjust Button (Knee Angle)
- (J) - Steering Column Release Pedal
- (K) - Deceleration (Decel) Pedal
- (L) - Operator Foot Pegs (2)
- (M) - Horn
- (N) - Windshield Washer
- (O) - Turn Signal Lever
- (P) - Windshield Wiper Speed
- (Q) - High Beams (Brights)

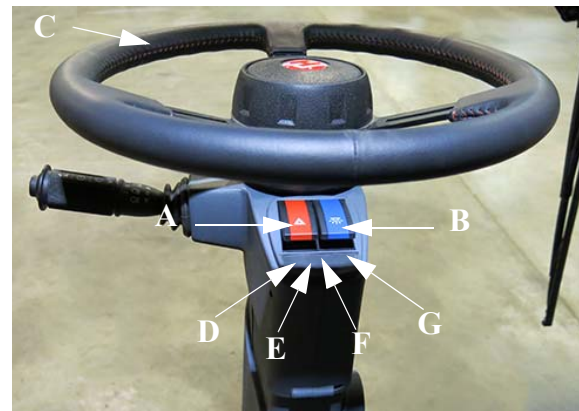

-Typical View



-Typical View

OPERATOR'S STATION

Front Console

- (A) - Hazard/Warning Lights Switch
- (B) - Highway/Running Lights Switch
- (C) - Steering Wheel
- (D) - Turn Signal Indicator (Left)
- (E) - Highway Running Lights Indicator
- (F) - High Beams Indicator
- (G) - Turn Signal Indicator (Right)
- (H) - Steering Wheel Telescope Adjust Handle



-Typical View

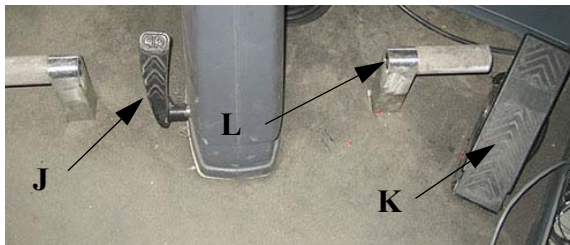

-Typical View

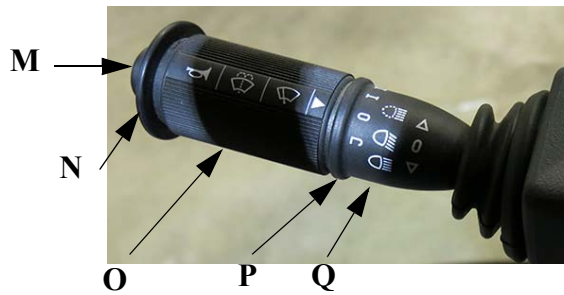

-Typical View

Hazard/Warning Lights

The Hazard/Warning Lights (located on each side of the front/rear machine and hood) are to be used at any time, day or night, that you are traveling on a public roadway, unless prohibited by law.

NOTE: The machine's drive state must be in Road Mode to activate the Hazard/Warning Lights.

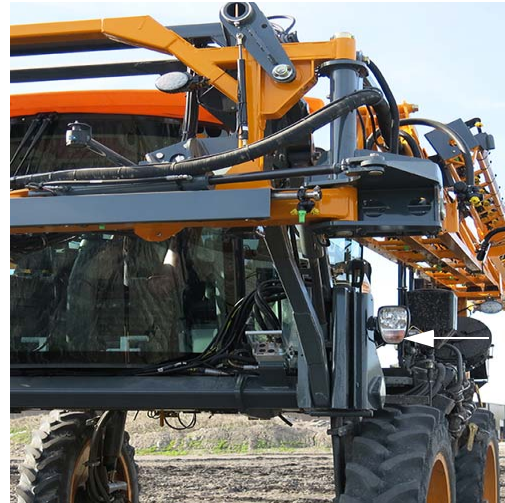

Hazard/Warning Lights
(Located on each side of the front/rear machine and hood)

-Typical View

** Hazard/Warning Light (bottom section of light assembly) mounted on front of machine shown.*

- To activate the Hazard/Warning Lights, press the Hazard/Warning Lights Switch (located on steering column) in the DOWN (On) position.
- Press the Hazard/Warning Lights Switch in the UP (Off) position to deactivate.



Hazard/Warning Lights Switch
(Located on steering column)

-Typical View

Highway Running Lights

The Highway Running Lights (located on each side of cab) are to be used when traveling on a public roadway at night.

NOTE: The Highway Running Lights operate in both Road and Field Mode.

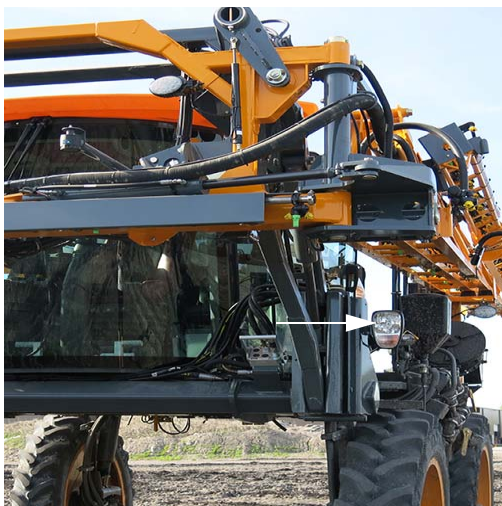

Highway Running Lights
(Located on each side of cab)
-Typical View

** Highway Running Light (top section of light assembly) mounted on front of machine shown.*

- To activate the Highway Running Lights, press the Highway Running Lights Switch (located on steering column) in the DOWN (On) position.
- Press the Highway Running Lights Switch in the UP (Off) position to deactivate.

NOTE: The Highway Running Lights Indicator (located near the steering wheel) will illuminate when activated.



Highway Running Lights Switch
(Located on steering column)
-Typical View

NOTE: Highway Running Lights are enabled when the key is in the ON position. However, prolonged use of these lights without the engine running is not recommended.

Steering Wheel Telescope Adjust

The Steering Wheel Telescope Adjust allows movement of the upper portion of the steering column to best suit your driving needs.

- To adjust the steering wheel, lift the Steering Wheel Telescope Adjust Handle (located to the right of the steering column) UP to loosen enough to freely move the steering wheel.



Steering Wheel Telescope Adjust Handle
(Located to the right of the steering column)
-Typical View

- With the handle loosened, adjust steering wheel to desired position. While holding the wheel in position, release the Steering Wheel Telescope Adjust Handle to lock into place.

Steering Column Tilt Adjust (Knee Angle)

The Steering Column Tilt Adjust allows you to angle the top section of the steering column to the position that best suits your comfort needs.

To tilt top section of steering column down:

- Lift and hold the Steering Column Tilt Adjust Button (located on the left-hand

side of the steering column) in the UP position.



Steering Column Tilt Adjust Button
(Located on the left-hand side of the steering column)
-Typical View

- While maintaining the Steering Column Tilt Adjust Button in the upward position, pull steering wheel BACKWARD (toward the operator).
- Release button when steering column is in the desired position.

To tilt top section of steering column up:

- Lift and hold the Steering Column Tilt Adjust Button (located on the left-hand side of the steering column) in the UP position.
- While maintaining the Steering Column Tilt Adjust Button in the upward position, allow steering wheel to move FORWARD (away from the operator).
- Release button when steering column is in the desired position.

Steering Column Release Pedal

CAUTION

Ensure the steering wheel and steering column are in the locked position before attempting to operate the machine. Failure to comply may result in difficulty maintaining control of the machine.

The Steering Column Release Pedal is featured for ease of exiting and entering the cab.

- With your foot on the Steering Column Release Pedal (located on the lower left-hand side of the steering column), push pedal DOWN and move the steering column to desired position.



Steering Column Release Pedal
(Located on the lower left-hand side of the steering column)
-Typical View

- To lock the steering column in desired position, remove your foot from the Steering Column Release Pedal while holding the steering column in place.
- Once the steering column has engaged into locked position, firmly move the steering column in either direction to ensure security.

Deceleration (Decel) Pedal

When nearing an end row and speed deceleration is desired, press the Decel Pedal (located to the lower right-hand side of the steering column) to decrease speed.

NOTE: The Decel Pedal is NOT a brake! It is designated for speed reduction only.



Decel Pedal
(Located to the lower right-hand side of the steering column)
-Typical View

Refer to “Machine Display” provided elsewhere in this section for information on adjusting Decel Pedal minimum speed.

Operator Foot Pegs

Operator Foot Pegs are located on each side of the steering column to provide added comfort and stability while operating the machine.



Operator Foot Pegs
(Located on each side of the steering column)
-Typical View

Horn

The Horn is sounded by pressing the Horn Button (located on the end of the Turn Signal Lever) INWARD.



Horn Button
(Located on the end of the Turn Signal Lever)
-Typical View

Windshield Washer

The Windshield Washer Switch is located on the end of the Turn Signal Lever. To apply washer fluid, press and hold switch in the IN position.

NOTE: Ensure there is adequate amount of washer fluid in the windshield washer fluid reservoir (located behind the left-hand side of cab) before operating.



Windshield Washer Switch
(Located on the end of the Turn Signal Lever)
-Typical View

Windshield Wiper Speed

To increase or decrease Windshield Wiper speed, rotate the Turn Signal Lever forward or backward to achieve Hi, Low, or Intermittent wiper speed.



Windshield Wiper Speeds
 (Located on the Turn Signal Lever)
 -Typical View



High Beams
 (Located on the Turn Signal Lever)
 -Typical View

Turn Signals

To activate the front and rear Turn Signals, move the Turn Signal Lever (located on the left-hand side of the steering column) FORWARD (away from operator) to signal a right turn, or BACKWARD (toward operator) to signal a left turn.

NOTE: The machine's drive state must be in Road Mode to activate the Turn Signals.



Turn Signal Lever
 -Typical View

NOTE: Steering column-mounted and Machine Display indicator lights will flash correspondingly when either turn signal is activated.

High Beams (Brights)

- To turn the High Beams ON, push the Turn Signal Lever (located on the left-hand side of the steering column) DOWN.
- To turn the High Beams OFF, push the Turn Signal Lever UP.

Side Console

- (A) - Emergency Stop Switch
- (B) - 60-ft. Nitrogen Tool Bar Operating Switches (if equipped)
- (C) - Boom Solution Valve Switches
- (D) - Fence Row Switch (Left)
- (E) - Rate Control Switches
- (F) - Rear Nozzle Switch
- (G) - Pump Speed/Rate Switches
- (H) - Fence Row Switch (Right)
- (I) - Main Tank Valve Switch
- (J) - Solution Pump Switch
- (K) - Agitation Valve Switch
- (L) - Rinse Switch
- (M) - Boom Extension Switches
- (N) - Foam Marker Switch (if equipped)
- (O) - Ignition Switch
- (P) - Power Mirror Switch (if equipped)
- (Q) - Hydrostatic Drive Control Handle
- (R) - Right-Hand Boom Switch
- (S) - Left-Hand Boom Switch
- (T) - End Row Management Switch
- (U) - Transom Switch(es) - Up/Down
- (V) - Master Spray Switch
- (W) - Shift Up Switch
- (X) - Shift Down Switch
- (Y) - Throttle Switch
- (Z) - Parking Brake Switch (if equipped)
- (AA) - Remote Stereo Controls
- (BB) - 12V Power Ports
- (CC) - Auxiliary 2 Audio Input Connection

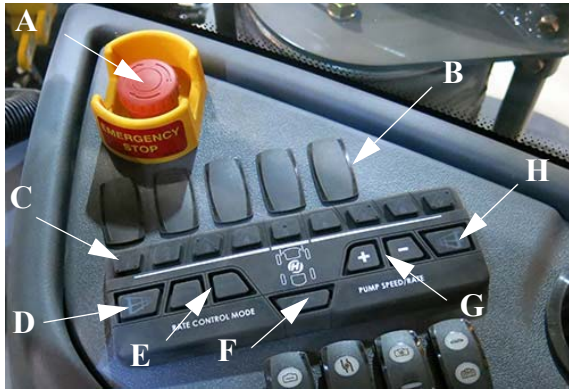

-Typical View



(Version 2 - Front View)
-Typical View



-Typical View



(Version 1 - Rear View)
-Typical View

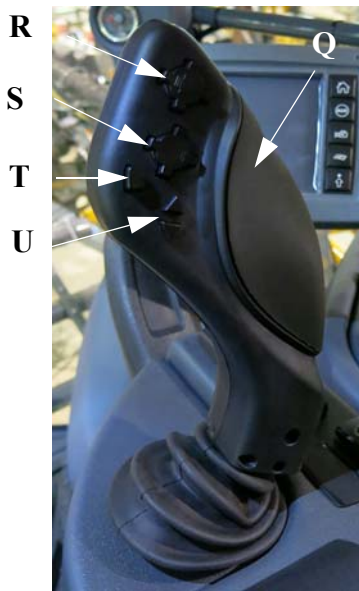

(Version 1 - Front View)
-Typical View



(Version 2 - Side View)
-Typical View



-Typical View

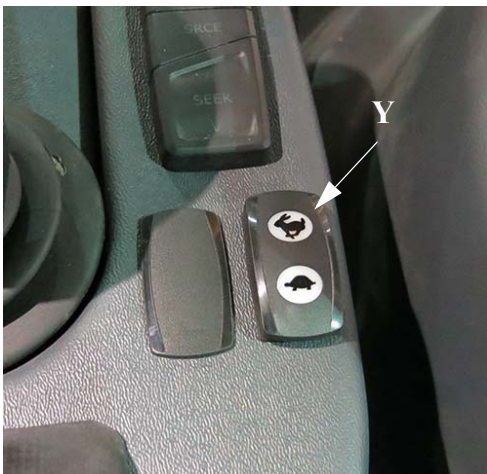

-Typical View

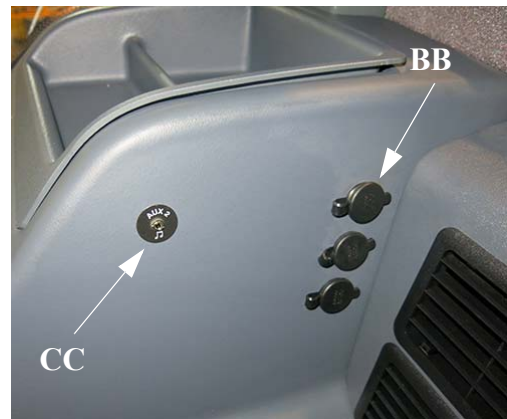

-Typical View

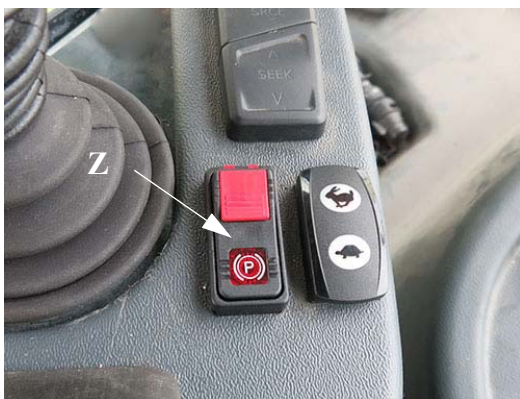

-Typical View

* If equipped with Hydrostatic
Drive Control Handle - Version 2

Emergency Stop (E-Stop)

The E-Stop Switch (located on the side console) provides a quick and positive method for stopping the engine in an emergency situation.

NOTE: DO NOT use this button for non-emergency stopping or as a parking brake.



E-Stop Switch
(Located on the side console)
-Typical View



Boom Solution Valve Switches
(Located on the side console)
-Typical View

Refer to the *Safety and Precautions Section* provided elsewhere in this manual for further information.

**60-ft. Nitrogen Tool Bar
Operating Switches**

- If Equipped

Refer to your NTB operator’s manual for operating instructions.



60’ NTB Switches
(Located on the side console)
-Typical View

Boom Solution Valve Switches

The Boom Solution Valve Switches (located on the side console) each control a valve located on the boom or transom. The valves control the flow of the solution through the boom.

The boom is divided into sections, with the far left tip being the beginning of the first section. Each Boom Solution Valve Switch is equipped with an indicator light and will illuminate red when manually turned off.

Refer to the *Spray Systems Section* elsewhere in this manual for further information.

Fence Row Switches

The Fence Row Switches (located on the side console) are used in the selection of either the right or left fence row spray nozzle.



Fence Row Switches
(Located on the side console)
-Typical View

Refer to “Fence Row Application” provided in the *Spray Systems Section* elsewhere in this manual for further information.

Rear Nozzle Switch

The Rear Nozzle Switch (located on the side console) controls the two (2) rear nozzles (located behind the rear tires).



Rear Nozzle Switch
(Located on the side console)
-Typical View

Refer to the *Spray Systems Section* elsewhere in this manual for further information.

Rate Control Switches

The Rate Control Switches (located on the side console) control the rate in which solution is applied through the spray booms by either the rate controller (Enable) or operator-controlled spray rate (Manual).

NOTE: When both “MAN” and “ENABLE” Rate Control Switches are pressed, manual rate control is activated through the rate controller.



Rate Control Switches
(Located on the side console)
-Typical View

Refer to the *Spray Systems Section* elsewhere in this manual for further information.

Pump Speed/Rate Switches

The Pump Speed/Rate Switches (located on the side console) allow you to increase or decrease flow rate through the spray system.

NOTE: When the “MAN” Rate Control Switch is pressed, the Pump Speed/Rate Switches increase or decrease pump speed/application rate from the Hagie control system. When the “ENABLE” Rate Control Switch is pressed (with either “MAN” active or inactive), a third party rate controller increases or decreases pump speed/application rate.



Pump Speed/Rate Switches
(Located on the side console)
-Typical View

Refer to the *Spray Systems Section* elsewhere in this manual for further information.

Main Tank Valve Switch

The Main Tank Valve Switch (located on the side console) controls the solution tank valve. This switch must be in the ON (Open) position for spray application.



Main Tank Valve Switch
(Located on the side console)
-Typical View

Refer to the *Spray Systems Section* elsewhere in this manual for further information.

Solution Pump Switch

The Solution Pump Switch (located on the side console) is used to turn the Solution Pump ON/OFF.



Solution Pump Switch
(Located on the side console)
-Typical View

NOTE: Leaving the Solution Pump Switch in the ON position can cause the pump to run continuously, which may result in system damage.

Refer to the *Spray Systems Section* elsewhere in this manual for further information.

Agitation Valve Switch

The Agitation Valve Switch (located on the side console) controls the rate of flow through the Agitation System.



Agitation Valve Switch
(Located on the side console)
-Typical View

Refer to the *Spray Systems Section* elsewhere in this manual for further information.

Rinse Switch

The Rinse Switch (located on the side console) is used to rinse the solution tank and spray booms.

NOTE: When rinsing the boom and nozzles, ensure the Boom Solution Valve Switches (located on the side console) are in the ON position before activating the Rinse Switch.



Rinse Switch
(Located on the side console)
-Typical View

Refer to “Rinse System” provided in the *Spray Systems Section* elsewhere in this manual for further information.

Boom Extension Switches (Outer Fold)

WARNING

When operating or positioning the booms, observe the following safety precautions to avoid serious injury or death:

- Select a safe area before folding/unfolding booms.
- Clear area of personnel.
- Check for overhead obstructions.
- Do not fold/unfold booms near power lines. Contact with power lines can result in serious injury or death.



CAUTION

When operating or positioning the booms, observe the following safety precautions to avoid injury or equipment damage.

- Do not fold/unfold boom extensions when main boom is in cradle.
- Do not operate sprayer with one boom out of cradle and the other boom in cradle.
- Do not transport machine without booms folded and in cradle.

The Boom Extension Switches (located on the side console) are used to extend or retract the outer boom extensions.

NOTE: On 90-ft. Spray Booms, operate Boom Extension Switch 1 to unfold/fold the outer boom extensions simultaneously. On 120 and 132-ft. Spray Booms, operate both Boom Extension Switches 1 (left) and 2 (right) to unfold/fold the outer boom extensions separately.

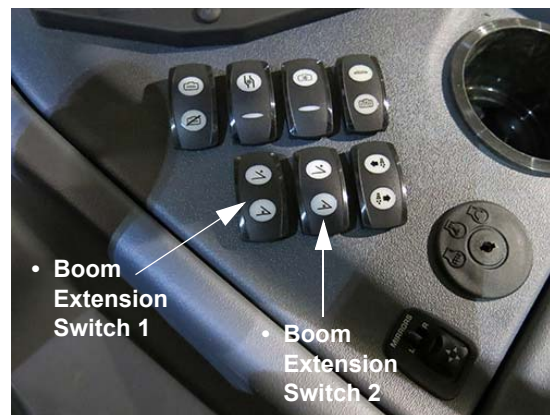

Boom Extension Switches
(Located on the side console)
-Typical View

Refer to the *Spray Systems Section* elsewhere in this manual for further information.

Foam Marker Switch

- If Equipped

The Foam Marker Switch (located on the side console) controls foam application on both sides of the machine.



Foam Marker Switch
(Located on the side console)
-Typical View

Refer to “Foam Marker” provided in the *Spray Systems Section* elsewhere in this manual for further information.

Ignition Switch

The Ignition Switch (located on the side console) has three positions - OFF, ON, and START. Before engaging the starter, turn the ignition key to the ON position and wait for the “wait to start” message to disappear on the Machine Display.

NOTE: The parking brake must be engaged before engaging the starter.



Ignition Switch
(Located on the side console)
-Typical View

- **To engage the starter**, turn the key to the START position and hold momentarily until the engine engages. If the engine does not engage after 15 seconds, turn the key to the OFF position.

NOTE: Constant cranking of the starter will cause damage to the battery and starting system.

Power Mirrors

-If Equipped

Your machine may be equipped with Power Mirrors for your operating convenience.

- Press the L/R Lever in the “L” position to adjust the LEFT mirror or in the “R” position to adjust the RIGHT mirror.
- Press the Adjust Switch to adjust the corresponding mirror to desired position.



Power Mirror Switch
(Located on the side console)
-Typical View

Hydrostatic Drive Control Handle

NOTE: Your machine is equipped with either Version 1 or Version 2 of the Hydrostatic Drive Control Handle. In addition to difference in the placement of controls, Version 1 allows the parking brake to engage/disengage through the Hydrostatic Drive Control Handle (moving the handle fully to the right). For machines equipped with Version 2, a separate parking brake switch is located adjacent to the Hydrostatic Drive Control Handle. Refer to specific operating instructions for your machine.

The Hydrostatic Drive Control Handle controls various functions of the machine and attachments. It is used to control the direction of the machine and the speed in which it travels, parking brake engagement (Version 1), and ladder extension/retraction. It is also used to control the spray booms, end row management, master spray, and shift up/down speeds.



Front View Rear View

Hydrostatic Drive Control Handle
(Version 1)
-Typical View



Front View Side View

Hydrostatic Drive Control Handle
(Version 2)
-Typical View

Refer to the *Engine and Drive Systems* and *Spray Systems* Sections elsewhere in this manual for further information.

Left and Right-Hand Boom Switches

The Left and Right-Hand Boom Switches (located on the Hydrostatic Drive Control Handle) are used to raise, lower, extend, and retract the spray booms.

End Row Management Switch

The End Row Management Switch (located on the Hydrostatic Drive Control Handle) is a programmable switch that enables various functions (i.e. All-Wheel

Steer, Auto Steer, Master Spray, and NORAC® Enable) when the switch is depressed.

Refer to “Machine Display” provided elsewhere in this section for programming information.

Transom Switch(es) - Up/Down

The Transom Switch(es) (located on the Hydrostatic Drive Control Handle) are used to raise and lower the main lift.

Master Spray Switch

The Master Spray Switch (located on the Hydrostatic Drive Control Handle) activates the boom solution valves.

Shift Up/Down Switches

The Shift Up/Down Switches (located on the Hydrostatic Drive Control Handle) are used for speed range selection.

Refer to “Hydrostatic Drive” provided in the *Engine and Drive Systems Section* elsewhere in this manual for further information.

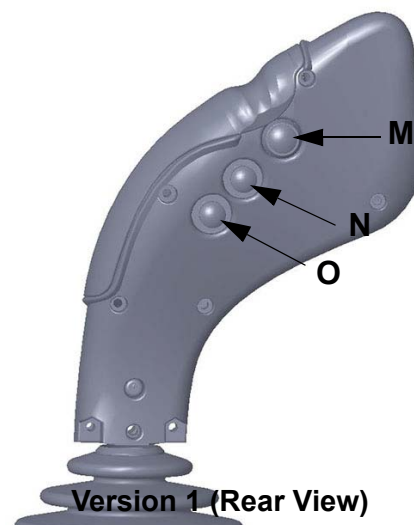
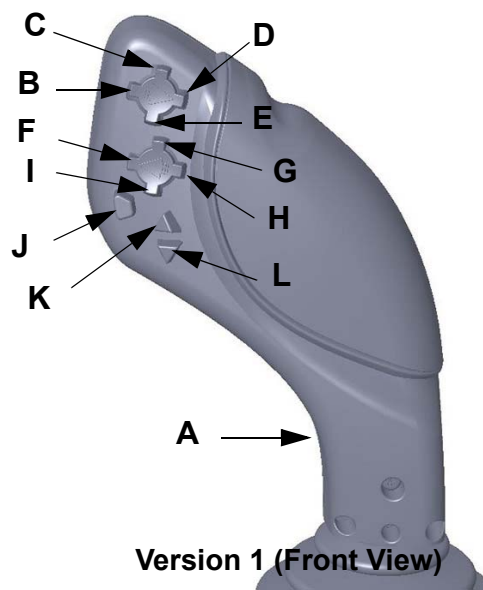

- (A) - Hydrostatic Drive Control Handle
- (B) - Right-Hand Boom IN
- (C) - Right-Hand Boom UP
- (D) - Right-Hand Boom OUT
- (E) - Right-Hand Boom DOWN
- (F) - Left-Hand Boom OUT
- (G) - Left-Hand Boom UP
- (H) - Left-Hand Boom IN
- (I) - Left-Hand Boom DOWN
- (J) - End Row Management Switch
- (K) - Transom Up Switch
- (L) - Transom Down Switch
- (M) - Master Spray Switch
- (N) - Shift Up Switch
- (O) - Shift Down Switch

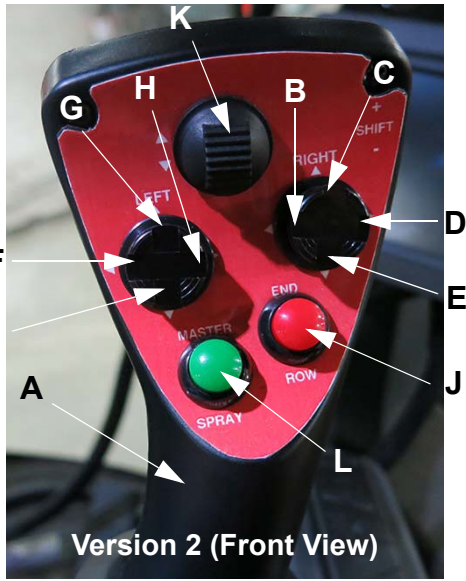

- (A) - Hydrostatic Drive Control Handle
- (B) - Right-Hand Boom IN
- (C) - Right-Hand Boom UP
- (D) - Right-Hand Boom OUT
- (E) - Right-Hand Boom DOWN
- (F) - Left-Hand Boom OUT
- (G) - Left-Hand Boom UP
- (H) - Left-Hand Boom IN
- (I) - Left-Hand Boom DOWN
- (J) - End Row Management Switch
- (K) - Transom Switch
- (L) - Master Spray Switch
- (M) - Shift Up Switch
- (N) - Shift Down Switch

Throttle Switch

The Throttle Switch (located near the Hydrostatic Drive Control Handle) is used to control engine speed (RPM).

NOTE: The operator may select throttle setting by operating the Throttle Switch. However, engine speed is also controlled by movement of the Hydrostatic Drive Control Handle.



Throttle Switch
(Located near the Hydrostatic Drive Control Handle)
-Typical View

NOTE: Engine speed can range between 850 and 2300 RPM in both Road and Field Mode.

The Throttle Switch works with a timer to tell the engine how fast to run. The longer the operator holds the switch in either direction (press UP/“rabbit icon” to increase the speed, press DOWN/“turtle icon” to decrease the speed), the more the engine will speed up or slow down.

Parking Brake Switch (Hydrostatic Drive Control Handle - Version 2) -If Equipped

If your machine is equipped with Version 2 of the Hydrostatic Drive Control Handle, a separate Parking Brake Switch will be located adjacent to the handle.



Parking Brake Switch - *if equipped*
(Located near the Hydrostatic
Drive Control Handle)
-Typical View

Refer to “Hydrostatic Drive” provided in the *Engine and Drive Systems Section* elsewhere in this manual for further information.

Remote Stereo Controls

Your machine is featured with Remote Stereo Controls (located near the Hydrostatic Drive Control Handle) for your convenience.

- **Volume Button** - Press button UP or DOWN to increase or decrease stereo sound.
- **Mute Button** - Press button to silence/ mute stereo sound. Press again to resume sound.
- **Source Button** - Press button to toggle through the source selections (Radio, CD, MP3, etc.)

NOTE: The selected source will be shown on the stereo display.

- **Seek Button** - Press button UP or DOWN to toggle through the radio channels or CD/MP3 selections.



- Volume Button
- Mute Button
- Source Button
- Seek Button

Remote Stereo Controls
(Located near the Hydrostatic
Drive Control Handle)
-Typical View

Power Ports (12-Volt)

Four (4) Power Ports (three located on the inward side console panel and one located along the lower left-hand side of operator’s seat) are provided for the connection of additional items (such as radios and computer equipment).

NOTE: The Power Ports are not intended for the permanent connection of additional systems to the sprayer.

Auxiliary Audio Input Connection (Aux 2)

The Aux 2 Audio Input Connection (located on the inward side console panel) allows you to connect a personal i-Pod or MP3 player.

NOTE: An Aux 1 Audio Input Connection is located on the stereo/radio.

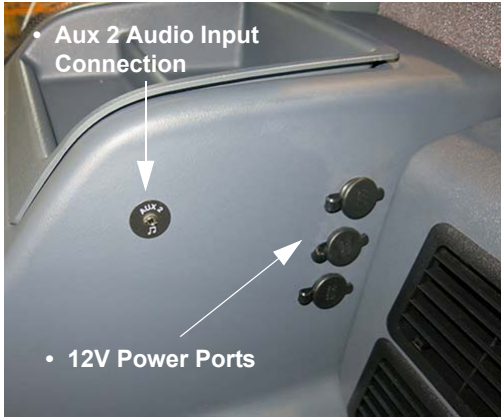

12V Power Ports and
Aux 2 Audio Input Connection
(Located on the inward side console panel)
-Typical View



-Typical View



-Typical View

Overhead Monitors and Controls

- (A) - Courtesy Light/Interior Work Light
- (B) - Stereo
- (C) - Climate Controls
- (D) - NORAC Monitor
- (E) - Spray System Console
- (F) - Machine Display
- (G) - Machine Gauges
- (H) - Section Indicator Display
- (I) - Detasseling Control Panel
- (J) - Tasselrol®/LS System 12™ Control Panel



-Typical View

(Your machine may vary according to model and available equipment)



-Typical View



-Typical View



-Typical View



-Typical View



Interior Work Light Switch
-Typical View

Stereo

The Stereo in your cab is featured with an AM/FM Tuner, Weatherband Broadcasting, CD Player, MP3 Player, USB/iPod Controls, and Bluetooth® (if equipped).

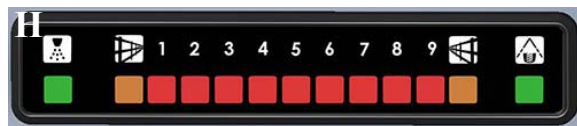

-Typical View

- Select/Volume Knob
- Disp Button



- Back Button
- Preset Buttons (1-6)



I

Courtesy Light/Interior Work Light

The Courtesy Light comes on automatically when the cab door is opened.

The Interior Work Light is activated by manually by pressing the Interior Work Light Switch (located on the light housing).

- Press switch UP to turn interior “white” light ON.
- Press switch DOWN to turn interior “red” light ON.
- Press switch in the mid-position to turn OFF.

Bluetooth Pairing (Registration)

-If Equipped

1. Press desired Preset Button (1-6) to select a registration number assigned to the Bluetooth device to be registered.

NOTE: Up to eight (8) devices of memory registered with Preset Buttons.

- (1-5) - Selects a registration number (1st page: 1-5, 2nd page: 6-8).
 - (6) - Turns the registration pages (Registration No. 6 - press 6, then press 1; Registration No. 7 - press 6, then press 2; Registration No. 8 - Press 6, then press 3).
2. Press and hold the selected Preset Button for 2+ seconds until “Pairing” flashes on the display.
 3. Quickly release the Preset Button and press the Select/Volume Knob until “Waiting” appears on the display.
 4. Operate your Bluetooth device to input the PIN number for connection.

Once pairing/registration is successful, the registered Bluetooth device can automatically communicate with this unit.

NOTE: Default PIN number = “0000”

- The text display of Bluetooth device name and telephone directory on this unit is only supported with English characters. Other languages and non-displayable characters/symbols will be converted into an asterisk (*).
- If registration is not successfully completed within one (1) minute, “TIME OUT” will appear and the screen for registration number selection resumes.
- If registration fails due to a mismatched PIN number, “PAIR ERR” will appear and the screen for registration number selection resumes.
- Depending on the communication status, it may take 5 to 40 seconds for device connection.

NOTE: Press the Disp Button at any time to exit waiting status.

Music Mode Activation

- Press and hold the Back Button for 2+ seconds.

NOTE: If the Back Button is held down for 2+ seconds again, phone mode is activated.

Refer to the Stereo manufacturer’s operation guide for complete operating instructions and programming information.

Climate Controls (Standard)



-Typical View

Fan Blower Speed (A)

- Rotate the Fan Blower Speed Dial “clockwise” to increase fan speed.
- Rotate the Fan Blower Speed Dial “counter-clockwise” to decrease fan speed.
- To shut the fan off, rotate the Fan Blower Speed Dial fully “counter-clockwise”.

Temperature Setting (B)

- Rotate the Temperature Setting Dial “clockwise” to increase temperature.
- Rotate the Temperature Setting Dial “counter-clockwise” to decrease temperature.

Air Conditioner Switch (C)

- To activate the air conditioner, press the Air Conditioner Switch in the ON position (toward switch indicator). Adjust the fan speed and temperature accordingly.

Climate Controls (Optional)

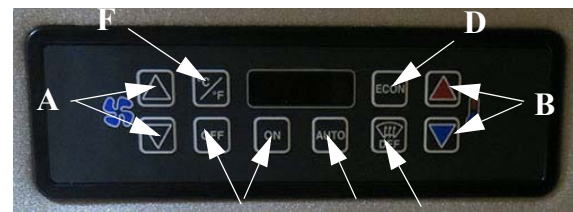

-Typical View

Fan Up/Down (A)

The Fan Up/Down Switches control the fan speed up or down in 11 increments and overrides the automatic fan speed control.

- Press desired switch UP to increase fan speed, or DOWN to decrease fan speed.
- The Digital Display indicates the fan speed setting as a percentage, or “HI” when maximum fan speed is obtained, or “LO” when minimum fan speed is obtained.

NOTE: The Digital Display will return to the normal display five seconds after either key is depressed.

The set point fan speed is maintained until it is changed, or until the Auto Mode Switch is depressed.

Temperature Up/Down (B)

The Temperature Up/Down Switches increments the cab set point temperature.

- Press desired switch UP to increase temperature, or DOWN to decrease temperature.

Defrost (C)

The Defrost Switch energizes the A/C system to allow for rapid cab dehumidification.

- Press the Defrost (DEF) Switch to turn ON.

NOTE: An indicator light will illuminate when defrost mode is active.

Economy Mode (D)

Economy Mode uses fresh air, fan speed, and water valve control to maintain the set point temperature. When active, A/C function is disabled.

- Press the Econ Switch to turn ON.
- Press the Econ Switch again to return the system back to normal operation.

NOTE: An indicator light will illuminate when Economy Mode is active.

Auto Mode (E)

Auto Mode allows the system to function in fully automatic temperature control mode, including automatic fan speed control. The system will adjust the fan speed to the lowest setting required to maintain cab set point temperature.

- Press the Auto Switch to turn ON and OFF.

NOTE: An indicator light will illuminate when auto mode is active.

Cab Temperature (F)

- Press the Cab Temp Switch to display set point on the Digital Display.

NOTE: Press the Cab Temp Switch and toggle between celsius (C) and fahrenheit (F) temperatures.

NOTE: Current cab temperature will be displayed for five seconds, then will return to the set point temperature display.

On/Off (G)

- The On/Off Switches power the cab heater/air conditioner systems ON or OFF.

NOTE: An LED numeric display is illuminated when the unit is turned on. The Digital Display will show the current set point temperature.

Cab Vents

Your cab is equipped with adjustable vents. Rotate to desired position, or individually turn on or off with the directional fins.



Cab Vent
-Typical View

Spray System Console

The spray system is controlled by the Spray System Console and the Solution Pump Control Valve. The system receives data and automatically makes adjustments based on the target rate of application set by the operator.



Spray System Console
-Typical View

Refer to the manufacturer’s operation manual for complete operating instructions and programming information.

NORAC Monitor

-If Equipped

The NORAC Monitor controls the automatic boom leveling system.



NORAC Monitor
-Typical View

Refer to the manufacturer’s operation manual for complete operating instructions.

Machine Display

The Machine Display in your sprayer is the central control center of the machine. It controls many of the machine’s electronically-driven functions (e.g. machine drive, AWS, attachment operation, tread adjustment, spray systems, lights, diagnostics, etc.)



Machine Display
-Typical View

Refer to “Machine Display” provided elsewhere in this section for a complete list of features and operating instructions.

Machine Gauges

Machine Gauges are located on the A-post in your cab and are conveniently placed for viewing machine diagnostics.

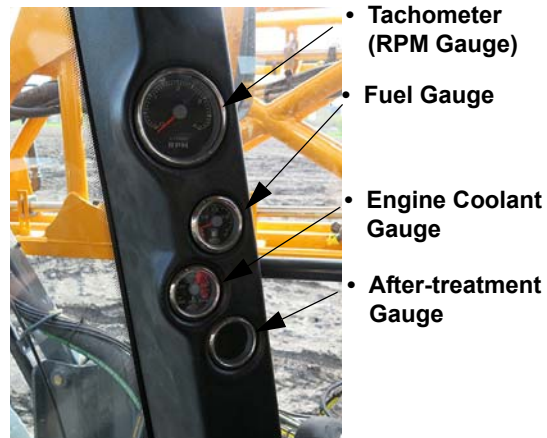

Machine Gauges
(Located on cab A-post)
-Typical View

Section Indicator Display

The Section Indicator Display allows you to view system status for the following:

- (1) - Master Spray Indicator (illuminates when ON).
- (2) - Fence Row Indicators (illuminate when ON).
- (9) - Spray Section Indicators (illuminate when OFF).
- (1) - Rear Wheel Nozzle Indicator (illuminates when ON).

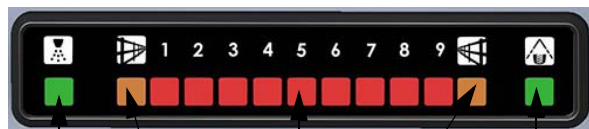

- Master Spray
- Left Fence Row
- Spray Section
- Right Fence Row
- Rear Wheel Nozzle

Section Indicator Display
-Typical View

Refer to the *Spray Systems Section* elsewhere in this manual for further information.

Detasseling Control Panel

The Detasseling Control Panel houses switches which activate Depth Command, Left/Right Fold, All-Up/Down, and Detasseling Head Motor functions.

Refer to the *Detasseling Systems Section* elsewhere in this manual for further information.

Tasselrol/LS System 12 Control Panel

The Tasselrol/LS System 12 Control Panel is used for programming the detasseling heads.

Refer to the *Detasseling Systems Section* elsewhere in this manual for further information.



Detasseling and Tasselrol/
LS System 12 Control Panels
-Typical View

Additional Features and Controls

Field and Work Lights

The Field Lights (located on the front of cab) and Work Lights (located on each boom cradle) are for use when operating in the field after dark and are turned on/off through the Machine Display.

NOTE: Turn Field and Work Lights OFF before entering a public roadway.

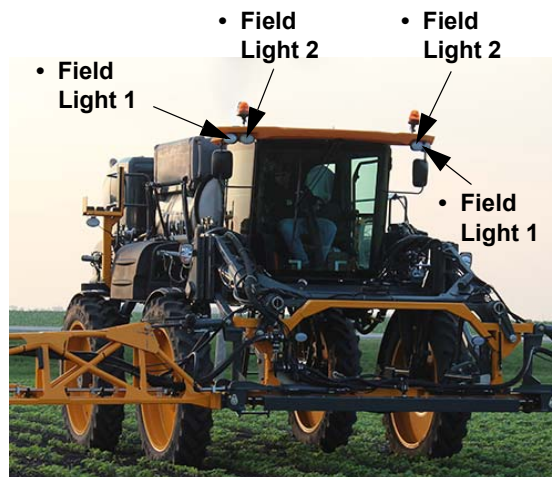

Field Lights
(Located on the front of cab)
-Typical View



Work Lights
(Located on each boom cradle)
-Typical View

NOTE: The ignition key must be in the ON position to operate the Field and Work Lights.

Refer to “Machine Display” provided elsewhere in this section for operating instructions.

Cab Filtration System

RESPA® Cab Filter

Your cab is featured with a dust and aerosol filtration system to provide continuous positive pressure in the cab by reducing exposure to harmful particulates.

NOTE: The filtration system will activate automatically approximately 10 seconds after machine start-up.



Cab Filtration System
(Located on the right-hand side of the exterior cab)
-Typical View

An indicator light (located on the Machine Display Home Page) will appear if insufficient cab air pressure should occur.

NOTE: The Insufficient Cab Air Pressure Indicator will appear each time the machine is started due to the initial activation delay. The indicator will disappear once the cab becomes pressurized.



Insufficient Cab Air Pressure Indicator
(Located on the Machine Display Home Page - Road or Field Mode)

Refer to the *Maintenance and Storage Section* elsewhere in this manual for filter replacement information.

Charcoal Cab Filter

Your cab is also featured with a Charcoal Filter (located behind the exterior service panel).

To access the Charcoal Filter:

- Remove the exterior service panel (located on right-hand side of cab).



Exterior Service Panel
(Located on right-hand side of cab)
-Typical View

- Remove the charcoal filter access panel (located behind the exterior service panel).

NOTE: A recirculation filter is attached to the back side of the charcoal filter access panel.

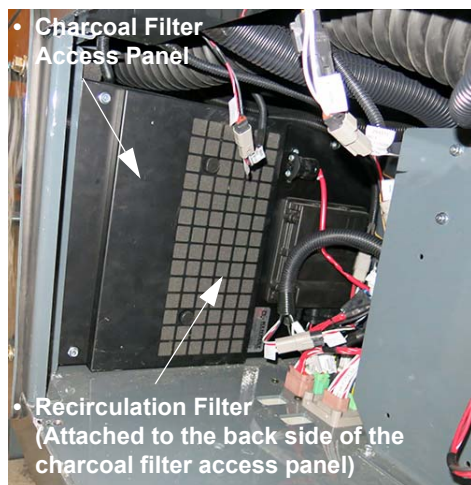

Charcoal Filter Access Panel
(Located behind exterior service panel on right-hand side of cab)
-Typical View

- Slide Charcoal Filter out.

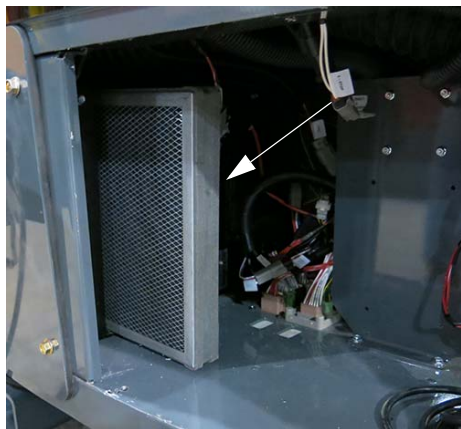

Charcoal Filter
-Typical View

Refer to the *Maintenance and Storage Section* elsewhere in this manual for information on replacing the charcoal filter and cleaning the recirculation filter.

Portable Electric Cooler

-If Equipped

Your machine may be equipped with a Portable Electric Cooler (located beneath the Instructor Seat) for your personal convenience. A 12-volt connection outlet is provided along side of the operator's seat.

MACHINE DISPLAY

(Typical View - Your machine may vary in appearance, depending on available equipment)

The Machine Display in your sprayer is the central control center of the machine. It controls many of the machine's electronically-driven functions, such as:

- Machine Drive
- All-Wheel Steer (if equipped)
- Attachment Operation
- Tread Adjustment (if equipped)
- Spray System
- Reversible Fan
- Backup Video Camera
- Exterior Lights
- Diagnostics



Machine Display
-Typical View

Machine Display Page Settings

The Machine Display is featured with six display pages:

- Home Page (Road Mode)
- Home Page (Field Mode)
- Auxiliary Controls Page
- Video Camera Page
- Machine Diagnostics Page
- Settings Page

Press the corresponding Page Display Button (located on the right-hand side of the Machine Display) to navigate through the display pages.



Page Display Buttons
(Located on the right-hand
side of the Machine Display)

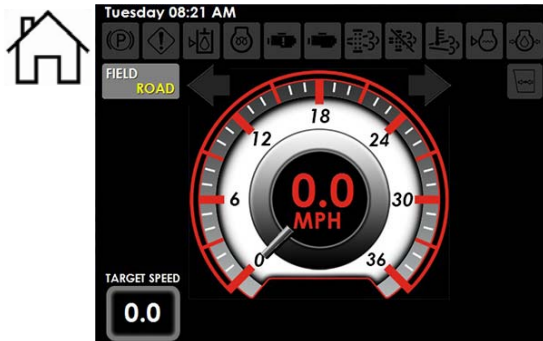

Home Page (Road Mode)

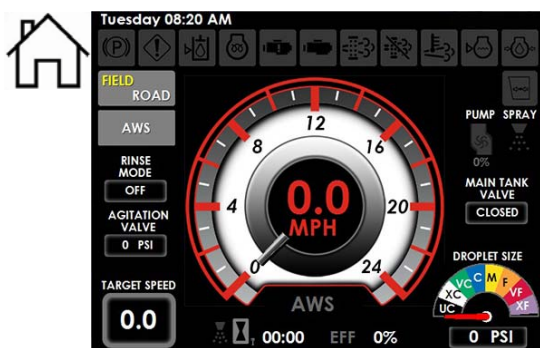

Home Page (Field Mode)

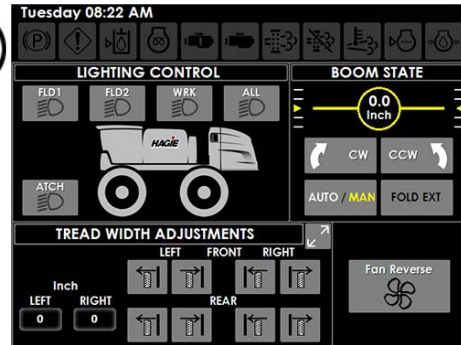

Auxiliary Controls Page

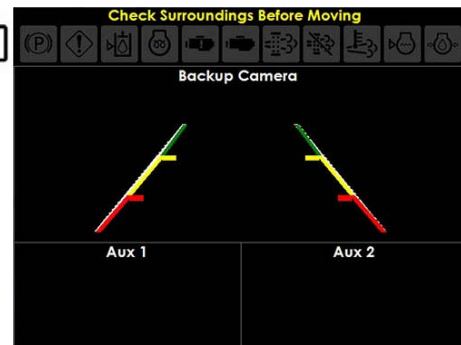

Video Camera Page

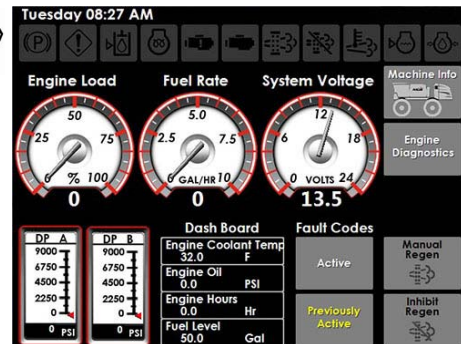

Machine Diagnostics Page

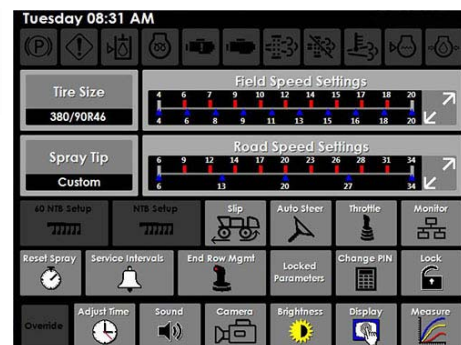

Settings Page

Speed Settings and Machine Adjustments

Throughout this manual, various adjustments are made through the Field/Road Speed Settings and Machine Adjustments (located on the Settings Page).

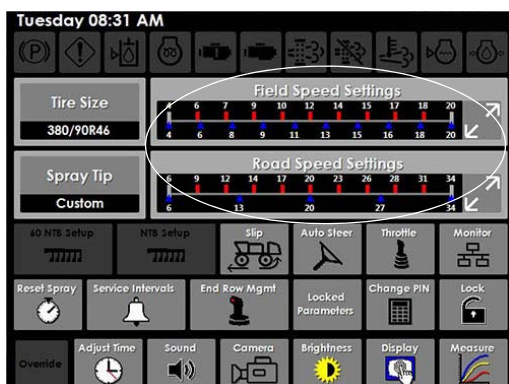

Speed Settings and Machine Adjustments
(Located on the Settings Page)

NOTE: The machine must be stationary before allowing certain Speed Setting and Machine Adjustments.

Field/Road Speed Settings

- First Range Top Speed
- Last Range Top Speed
- Number of Ranges
- AWS Shutoff Speed (Field Speed Settings only)

Machine Adjustments

Auto Steer

- SASA T-Delay On
- SASA T-Delay Off
- A-Steer Sensitivity

Slip (Traction Control)

- Slip Percent
- Slip Destroke

CAN Monitor

- Enable CAN1
- Enable CAN2
- Enable CAN3

Display

- Units (Standard/Metric)
- Animations

- Gauge Color
- Language

Camera

- Backup Camera
- Aux Camera 1
- Aux Camera 2
- Edit Overlay
- Settings
- Flip Vertical
- Flip Horizontal

Throttle

- Throttle Control Slope
- Throttle Up Ramp
- Throttle Max
- Decel Pedal Min Speed

End Row Management

- Single Press
- Press and Hold

Service Intervals

- 50-Hour Interval
- 100-Hour Interval
- 500-Hour Interval
- Hydraulic Filter
- Hydraulic Oil
- Engine Oil

NTB/60' NTB Setup -If Equipped

NOTE: Refer to your Nitrogen Tool Bar operator's manual for further information.

- NTB Override Timer
- Float With Transom Down
- One Tap Transom Up
- Main Lift Maximum*
- Left Section 3 Maximum*
- Left Section 2 Maximum*
- Right Section 3 Maximum*
- Right Section 2 Maximum*
- Section 1 Force Float*

** 60' NTB Adjustments only*

Machine Setting Security

To Lock Machine Settings

- Press the Locked Parameters Button (located on the Settings Page).

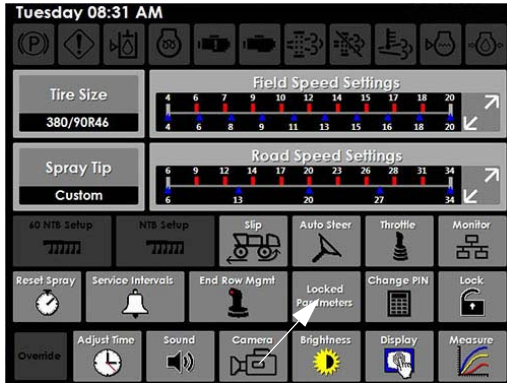

Locked Parameters Button
(Located on the Settings Page)

- On the “Change Locked Parameters” screen, press the Up/Down Arrow Buttons until desired setting is displayed.

NOTE: Single arrow buttons toggle up/down one page. Double arrow buttons toggle to either the first or last page.



Change Locked Parameters Screen

- Press the “lock icon” next to desired setting to the LOCKED position.
- Press OK.
- Press the Lock Button (located on the Settings Page).
- Press OK to confirm locked settings.

NOTE: When the Lock Button is pressed, the Locked Parameters and Change Pin Buttons will disappear. These buttons will re-appear when the Lock Button is pressed and the correct pin number is entered.

NOTE: Default Pin Number is “50525”.

To Unlock Machine Settings

- Press the “red illuminated” Lock Button (located on the Settings Page).

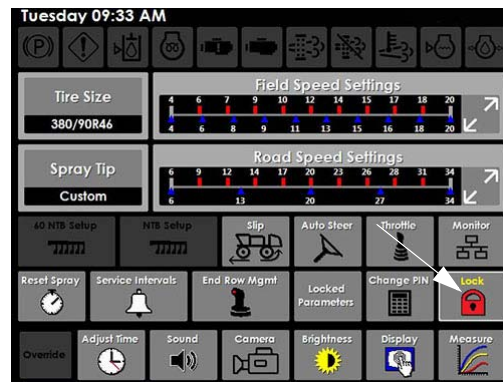

Lock Button
(Located on the Settings Page)

- On the “Enter Lock Password” screen, enter pin number.
- Press UNLOCK.

To Change Pin Number

- Press the Change Pin Button (located on the Settings Page).

NOTE: Press the Lock Button and enter current pin number to enable the “Change Pin Button” to re-appear on the display.

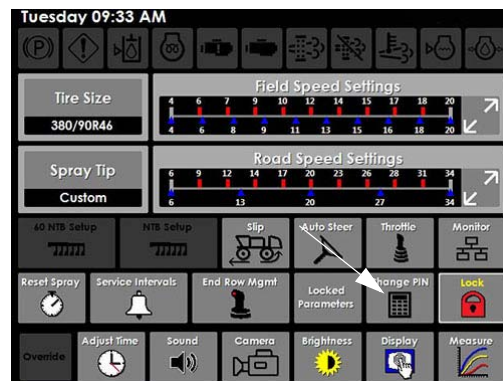













Change Pin Button
(Located on the Settings Page)

- On the “Set New Password” screen, enter newly-selected 5-digit pin.
- Press OK.

NOTE: A “Password Changed” confirmation will appear when complete.

Machine Display Indicators

To alert the operator of certain operations or when a machine system requires attention, various Machine Display Indicators are located on the top of each display page and illuminate to inform you of a specific situation.

-  • Parking Brake ON
-  • Machine Warning
-  • Check Engine
-  • Stop Engine
-  • Exhaust System Cleaning
-  • Engine Cleaning Stop
-  • High Exhaust Temperature (HEST)
-  • Low Diesel Exhaust Fluid (DEF)
(Tier 4 Final Engines)
-  • Low Engine Oil Pressure
-  • Low Engine Coolant Level
-  • Grid Heater ON
-  • Low Hydraulic Oil Level
-  • Insufficient Cab Air Pressure

Warning Light Indicator

When a system error requires attention, a Machine Warning Light Indicator (located on the top left-hand side of each display page) will illuminate. This indicator will be accompanied by a warning buzzer and a warning message telling you what the error is and what should be done to correct it.

NOTE: The error message may be cleared by pressing OK or ACKNOWLEDGE and the warning buzzer may be silenced by pressing the Sound

Button (located on the Settings Page) to the OFF (red illuminated “disabled”) position. However, the Warning Light Indicator will remain illuminated until the issue has been corrected.

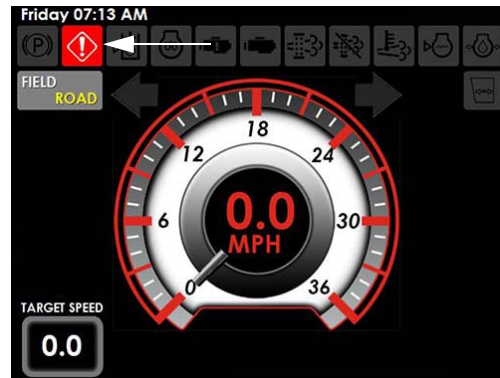

Warning Light Indicator
(Located on the top left-hand side of each display page)

Warning Buzzer

The Warning Buzzer alerts the operator when a system fault is detected and requires immediate attention. To silence the buzzer, press the Sound Button (located on the Settings Page) to the OFF (red illuminated “disabled”) position.

NOTE: The Sound Button will reset to the ON (enabled) position each time the ignition key is cycled.

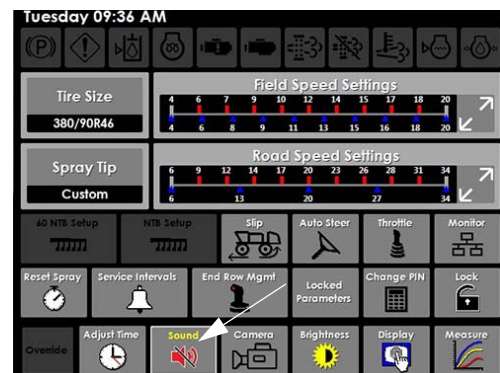

Sound Button
(Located on the Settings Page)

Lighting Adjustment

(Day Time/Night Time)

To Adjust the Display, Keypad, and Console Lighting

- Press the Brightness Button (located on the Settings Page).

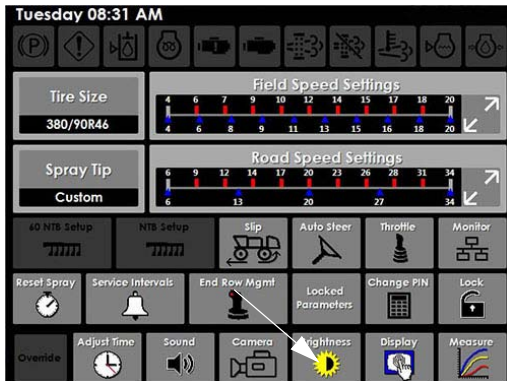

Brightness Button
(Located on the Settings Page)

- On the “Brightness” screen, press desired “Day Time” or “Night Time” Button.

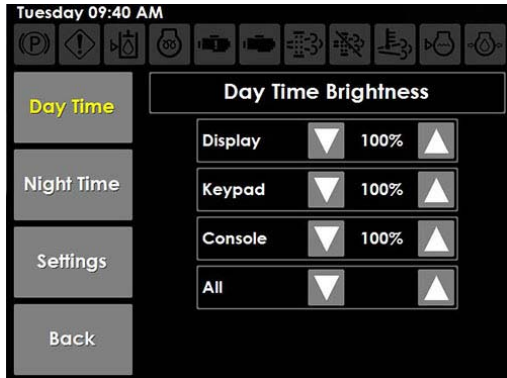

Brightness Screen

- Adjust corresponding day time and/or night time Display, Keypad, Console, or All brightness levels UP or DOWN to desired setting.
- Press BACK when finished.

To Set Automatic Night Time Transition Brightness

NOTE: Night Time brightness levels must be manually set (as previously described) before setting automatic transition brightness.

- On the “Brightness” screen, press the Settings Button.
- On the “Transition Settings” screen, press EDIT (next to Enable Time Transition).



Transition Settings Screen

- Select YES.
- Press OK.
- Press EDIT (next to Night Time Hour Start).
- Enter desired value (time of day that night time brightness will activate).
- Press OK.
- Press EDIT (next to Night Time Minute Start).
- Enter desired value (time of day that night time brightness will activate).
- Press OK.
- Press OK.
- Press BACK when finished.

Display Animation/Gauge Color/ Language

Display Animation

- Press the Display Button (located on the Settings Page).

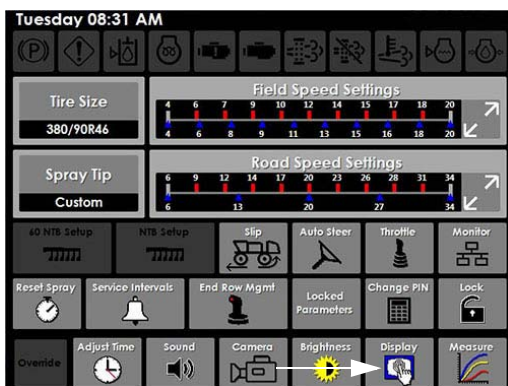

Display Button
(Located on the Settings Page)

- On the “Display Settings” screen, press EDIT (next to Animations) and select “Yes” to enable animations, or “No” to disable animations.

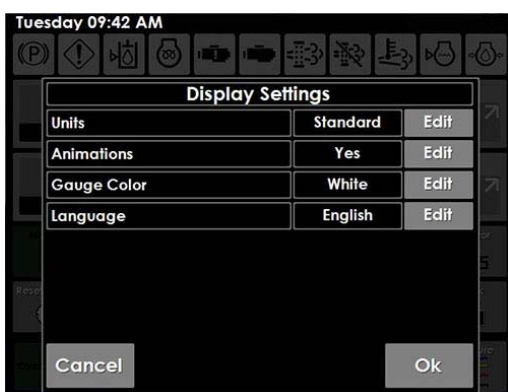

Display Settings Screen

- Press OK.

Gauge Color

- Press the Display Button (located on the Settings Page).
- On the “Display Settings” screen, press EDIT (next to Gauge Color).
- Select desired gauge color.
- Press OK.

Language

- Press the Display Button (located on the Settings Page).
- On the “Display Settings” screen, press EDIT (next to Language).
- On the “Language Selection” screen, select preferred language.
- Press OK.



Language Selection Screen

NOTE: Press and hold the Settings Page Display Button (located on the right-hand side of the Machine Display) for approximately 10 seconds to navigate directly to the “Language Selection” screen.

Date and Time

The date and time is located on the upper left-hand corner of each display page and is set to central-standard time.

To Change Date or Time

- Press the Adjust Time Button (located on the Settings Page).

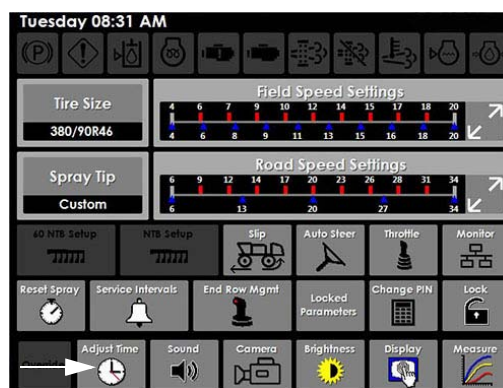

Adjust Time Button
(Located on the Settings Page)

- On the “Adjust Date and Time” screen, enter new date and time by pressing the corresponding Up/Down Buttons.

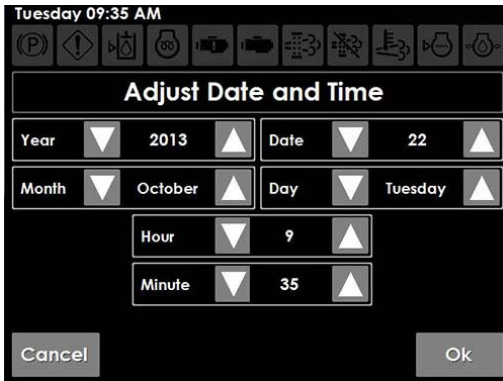

Adjust Date and Time Screen

- Press OK.

Machine Information

Machine information, such as total engine/machine hours, software version, attachment information, and machine serial number are located on the Machine Information screen.

- Press the Machine Information Button (located on the Machine Diagnostics Page) to view information.

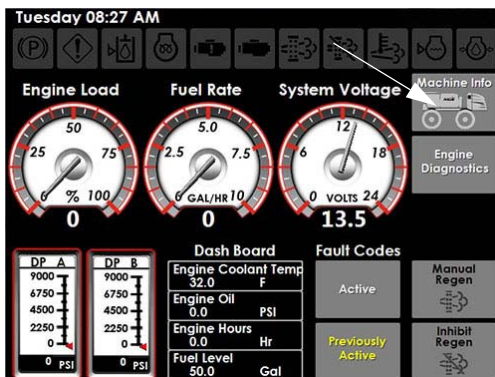

Machine Information Button
(Located on the
Machine Diagnostics Page)

Software Information

The Machine Display Software Information provides information on current software used and the date that it was released for the following:

- Primary Hydraulic Controller
- Secondary Hydraulic Controller
- Primary Display Controller

Attachment Information

The machine recognizes which attachment (e.g. 90-ft. Boom, 120-ft. Boom, Detasseler Tool Bar, or Nitrogen Tool Bar, if equipped) is connected to the machine and is displayed on the Machine Information screen.

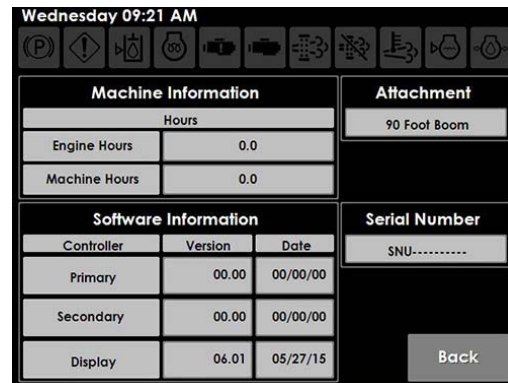

Machine Information Screen

Exterior Lights

The exterior machine lights are controlled by buttons (located on the Auxiliary Controls Page).

NOTE: The light buttons will illuminate when the Exterior Lights are in the ON position.

Field Light Buttons

The Field Lights are located on front of the cab.

- Press the Field Lights Button(s) (FLD1 and/or FLD2) to turn Field Lights ON. Press button(s) again to turn Field Lights OFF.

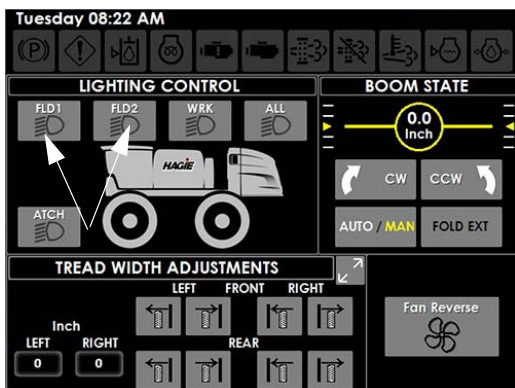

Field Light Buttons

(Located on the Auxiliary Controls Page)

NOTE: Turn Field Lights OFF before entering a public roadway.

NOTE: The ignition key must be in the ON position to operate the Field Lights.

Work Lights Button

The Work Lights are located on each of the boom cradles.

- Press the Work Lights Button (WRK) to turn Work Lights ON. Press button again to turn Work Lights OFF.

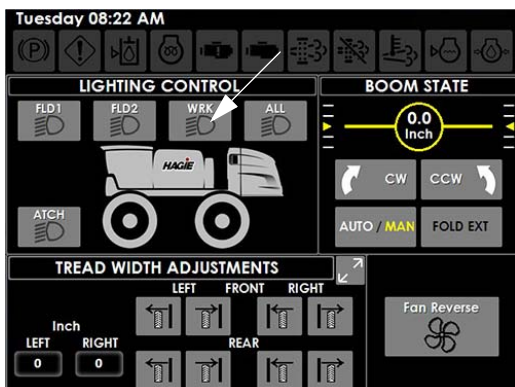

Work Lights Button

(Located on the Auxiliary Controls Page)

NOTE: Turn Work Lights OFF before entering a public roadway.

NOTE: The ignition key must be in the ON position to operate the Work Lights.

Attachment Lights Button

-If Equipped

The Attachment Lights are located on the transom.

- Press the Attachment Lights Button (ATCH) to turn Attachment Lights ON. Press button again to turn Attachment Lights OFF.

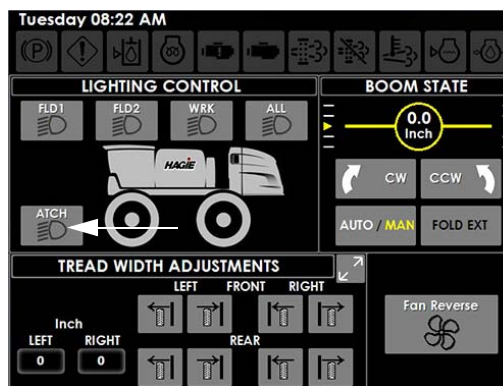

Attachment Lights Button

(Located on the Auxiliary Controls Page)

NOTE: Turn Attachment Lights OFF before entering a public roadway.

NOTE: The ignition key must be in the ON position to operate the Attachment Lights.

All Lights Button

- Press the All Lights Button (ALL) to turn on all lights (Field, Work, and Attachment, if equipped) ON. Press button again to turn all lights OFF.

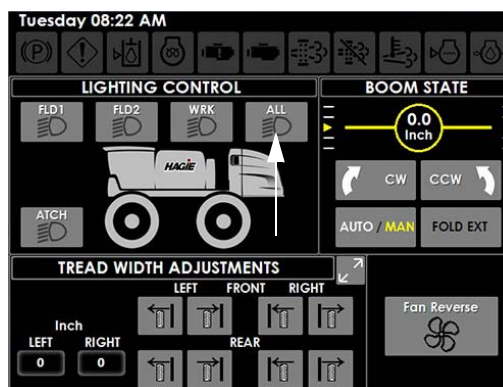

All Lights Button

(Located on the Auxiliary Controls Page)

NOTE: The ignition key must be in the ON position to operate the Exterior Lights.

Video Camera

Your machine is equipped with a Video Camera for your convenience when operating the machine in reverse and is located on the rear of the sprayer.

- On the Video Camera Page, press desired camera display to view in half-screen mode. Press again to view in full-screen mode.

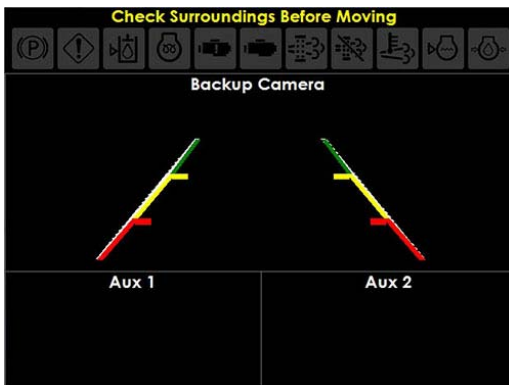

Video Camera Page

NOTE: Two additional video camera input connections (located beneath cab - remove front panel to access) are provided for the installation of add-on video camera(s). Refer to “Video Camera Input Connections” provided in the Electrical Systems Section elsewhere in this manual for further information.

Video Camera Settings

To Adjust Video Camera Settings

- Press the Camera Button (located on the Settings Page).

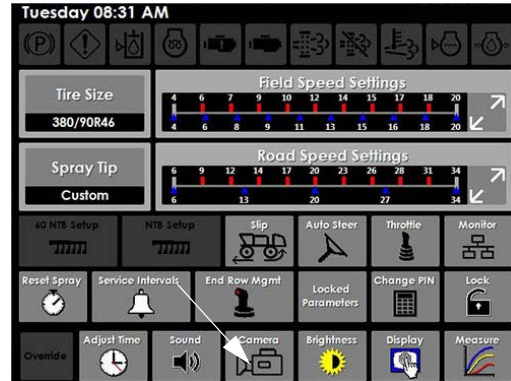

Camera Button
(Located on the Settings Page)

- On the “Camera Settings” screen, select either BACKUP CAMERA, AUX CAMERA 1, or AUX CAMERA 2.

NOTE: Press the “Flip Vertical” or “Flip Horizontal” Button to rotate object to desired position.

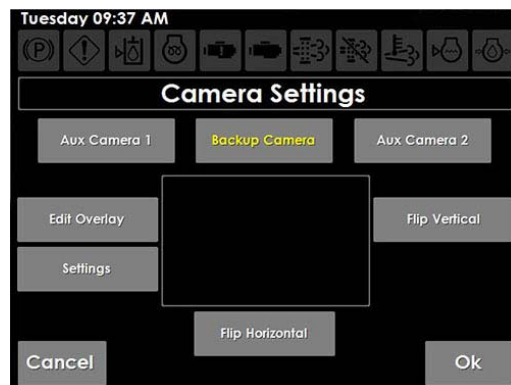

Camera Settings Screen

Edit Overlay

- Press the Edit Overlay Button (located on the “Camera Settings” screen).
- Select desired display adjustment (Top, Middle 1, Middle 2, or Bottom).

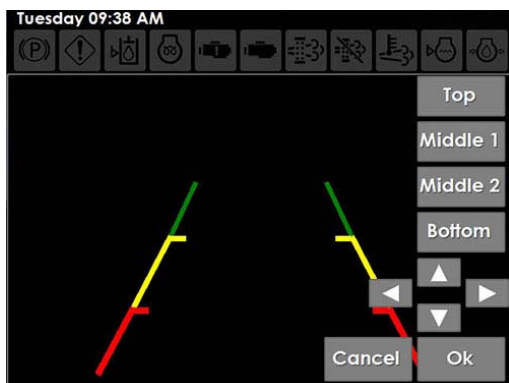

Edit Overlay Screen

- Drag display angle to desired position.
- NOTE: Press and hold the Arrow Buttons to “fine-tune” display angle.*

- Press OK.

Settings

- Press the Settings Button (located on the “Camera Settings” screen).
- On the “Camera Adjustable Settings” screen, press EDIT next to desired setting (Backup Camera in Reverse, Backup Camera Overlay, Backup Camera Projection, or Enable Camera in Road Mode).

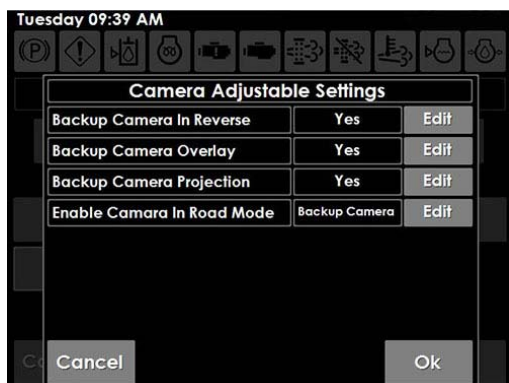

Camera Adjustable Settings Screen

- Press YES to activate, or NO to deactivate.

Service Intervals

To Change Service Interval Settings

- Press the Service Intervals Button (located on the Settings Page).

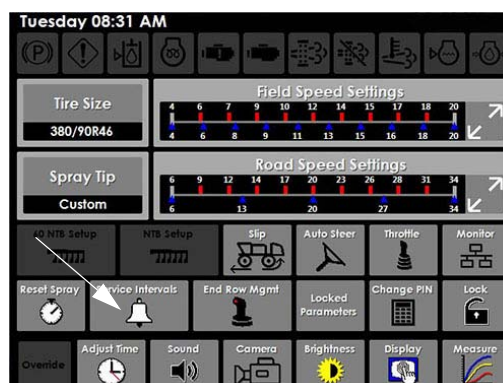

Service Intervals Button
(Located on the Settings Page)

- On the “Select Service Interval” screen, select desired service interval.

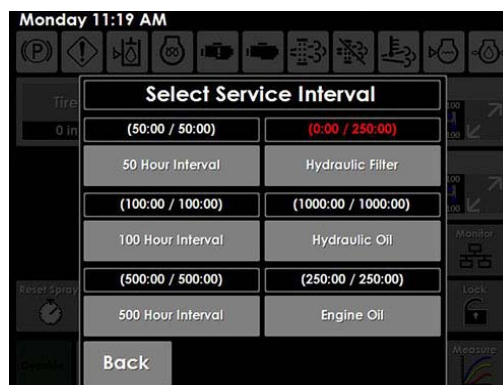

Select Service Interval Screen

- Press EDIT (next to the service interval you wish to change).
- Enter desired value.
- Press ACCEPT.
- Press RESET INTERVAL.
- Press BACK to return to the “Select Service Interval” screen. Press BACK again to return to the Settings Page.

Drive State

The Drive State of the machine is displayed on the Home Page - Road and Field Mode.

- Press the Field/Road Button (located on the Home Page) to toggle between the two Drive States. The selected Drive State will illuminate.

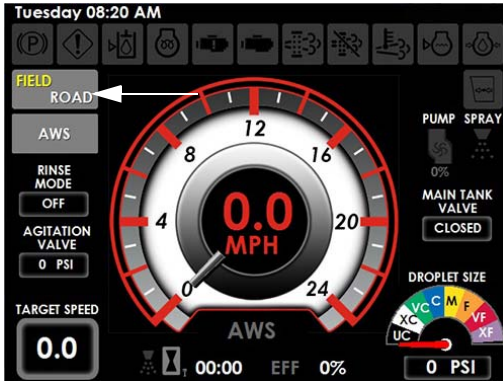

Field/Road Button
(Located on the Home Page - Road and Field Mode)

NOTE: The Drive State of the machine cannot be changed unless the Hydrostatic Drive Control Handle is in the NEUTRAL position (and machine speed is less than 0.5 mph/ 0.8 km/h).

The machine is featured with three (3) Drive States: ROAD, FIELD, and FAULT. The Drive State helps the machine determine what kind of work it is meant to do - field work or transport work.

Road Mode

In Road Mode, the machine is limited on what functions can be operated. Road Mode is used for transporting of the machine and therefore, will allow the machine to reach maximum speed.

NOTE: Engine speed in Road Mode can range from 850 to 2300 RPM.

Field Mode

In Field Mode, the machine is allowed function of attachments, such as Spray Booms, Detasseler Combo Tool Bar, and Nitrogen Toolbar (if equipped). All-Wheel Steer (if equipped) is also only allowed in Field Mode.

NOTE: Machine speed is limited and is unable to reach maximum speed while in Field Mode.

Drive Fault

The third drive state, “Drive Fault” may appear as a warning message on the display page if there is a system malfunction that affects the machine’s ability to function properly. This message will tell you why the error occurred and what, if anything, should be done to correct the issue. As a result, machine performance will be limited.

NOTE: When a Drive Fault is present, the Field/Road Button (located on the Home Page) will be replaced by “FAULT”. Settings will be in Field Mode.

Speedometer

The speed in which the machine travels is displayed on the Home Page - Road and Field Mode. The unit of measure can be viewed as miles per hour (MPH) or kilometers per hour (km/h).

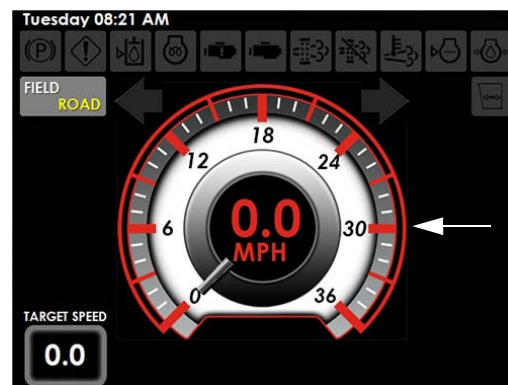

Speedometer
(Located on the Home Page - Road or Field Mode)

To Change the Unit of Measure

- Press the Display Button (located on the Settings Page).

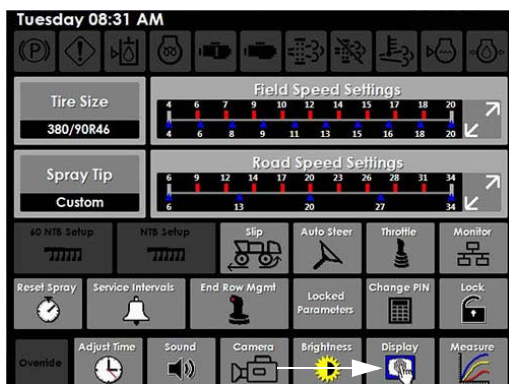

Display Button
(Located on the Settings Page)

- On the “Display Settings” screen, press EDIT (next to Units).

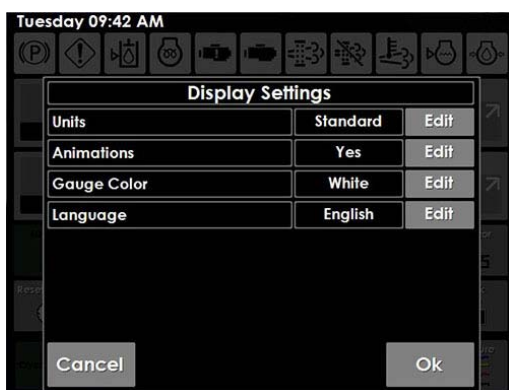

Display Settings Screen

- Select setting (standard or metric), then press OK.
- Press OK.

Target Speed

The Target Speed (displayed on the Home Page - Road and Field Mode) is the speed in which the machine travels when the Hydrostatic Drive Control Handle is in the fully FORWARD position and the Decel Pedal is NOT pressed.

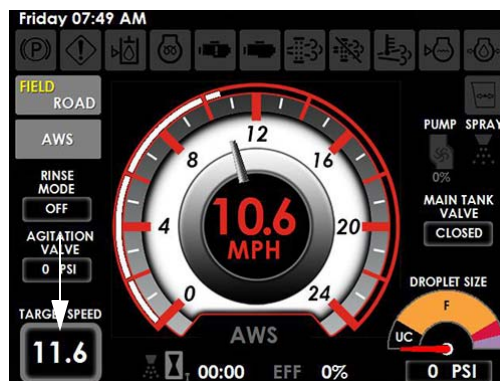

Target Speed
(Located on the Home Page - Road and Field Mode)

To Change Target Speed

- Press the Adjust Button (located on the Settings Page) for desired field or road speed setting.

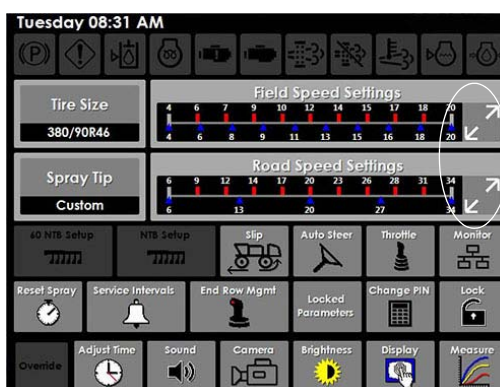

Adjust Buttons - Field/Road Speed Settings
(Located on the Settings Page)

- On the “Speed Settings” screen, evenly space target speeds as desired using the Up/Down Buttons for each setting (*First Range Top Speed, Last Range Top Speed, and Number of Ranges*).

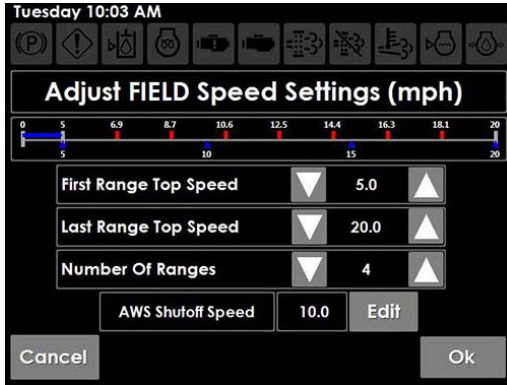

Speed Settings Screen
* *Field Speed Settings Shown*

Example:

If the “Number of Ranges Field” is set to 4, First Range Top Speed=5, and Last Range Top Speed=20, range selection would look like the following:

Range	1	2	3	4
Target Speed	5	10	15	20

- Press OK.

The machine will automatically adjust the new Target Speed according to the newly entered values.

Throttle

Throttle Control Slope

Determines how fast engine speed increases when the Throttle Switch (located near the Hydrostatic Drive Control Handle) is pressed in the UP (“rabbit icon”) position.

NOTE: Values are set as a percentage per second.

NOTE: If Throttle Control Slope is set at 25 percent/per second and Throttle Max is set at 100 percent, Throttle Up Ramp should be at least four (4) seconds to achieve 100 percent throttle when operating the Throttle Switch.

Throttle Up Ramp

Amount of time engine speed will increase or decrease when the Throttle Switch (located near the Hydrostatic Drive Control Handle) is pressed UP or DOWN.

Throttle Max

Maximum percentage that engine speed will achieve (e.g. If Throttle Max is set at 100 percent, throttle control will set engine speed between 850 and 2300 RPM. If Throttle Max is set at 0 percent, maximum engine speed will be 850 RPM).

NOTE: Pressing the Throttle Switch (located near the Hydrostatic Drive Control Handle) in the UP (“rabbit icon”) position will not increase engine speed when Throttle Max is set at 0 percent.

To Change Throttle Setting Values

- Press the Throttle Button (located on the Settings Page).

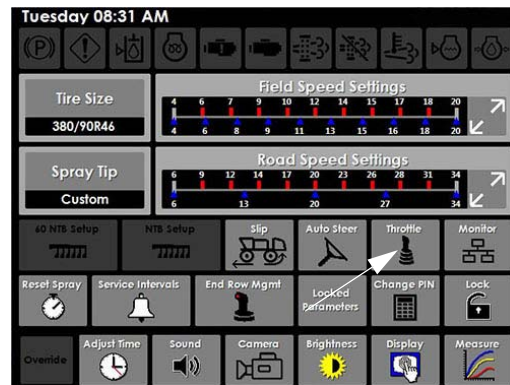

Throttle Button
(Located on the Settings Page)

- On the “Throttle Settings” screen, press EDIT (next to the desired Throttle setting).

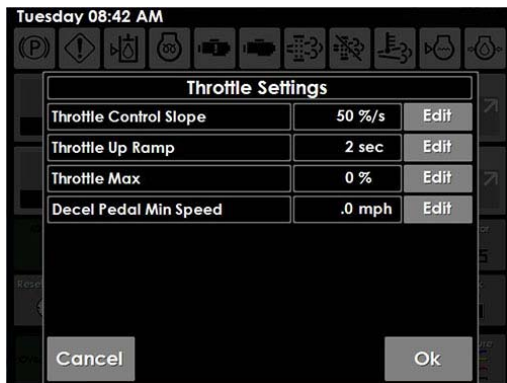

Throttle Settings Screen

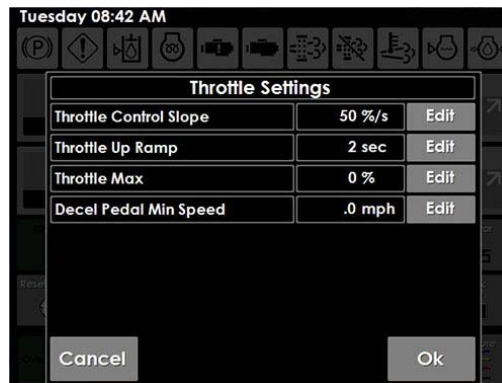

Throttle Settings Screen

- Enter desired value, then press ACCEPT.
- Press OK.

Refer to “Hydrostatic Drive” provided in the *Engine and Drive Systems Section* elsewhere in this manual for further information.

Decel Pedal Minimum Speed

The Decel Pedal (located to the lower right-hand side of steering column) is used for speed deceleration (e.g. when nearing an end row).

NOTE: The Decel Pedal is NOT a brake! It is designated for speed reduction only.

To Adjust Decel Pedal Minimum Speed

- Press the Throttle Button (located on the Settings Page).

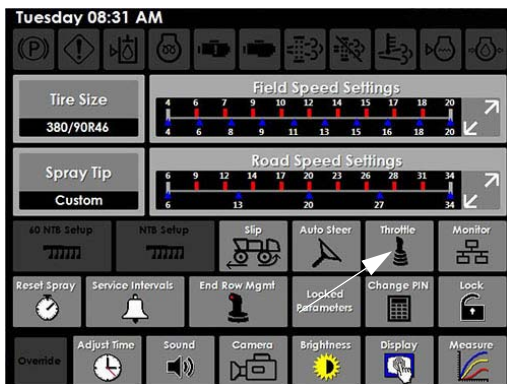

Throttle Button
(Located on the Settings Page)

- On the “Throttle Settings” screen, press EDIT (next to Decel Pedal Min Speed).

- Enter desired value, then press ACCEPT.
- Press OK.

All-Wheel Steer (AWS) ^

-If Equipped

The AWS Button is located on the Home Page - Field Mode. Enable AWS by pressing the button in the ON (illuminated) position. An AWS indicator (located below the speedometer) will illuminate when AWS is activated (requiring all conditions to be met).

- AWS Button

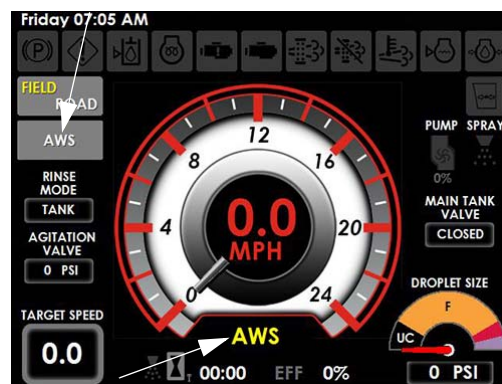

- AWS Indicator

All conditions must be met before AWS will activate. First, the machine must be in Field Mode, and second, machine speed must be less than AWS Shutoff Speed (mph-km/h). If these conditions are not met, the AWS Button will remain ON, but the AWS indicator will turn OFF, and the machine will be operating in conventional steering mode.

When conditions are met again, AWS will automatically activate and the AWS indicator will illuminate.

NOTE: The machine will automatically determine if the proper conditions have been met and change the status of the drive functions.

Shutoff Speed for AWS

NOTE: AWS Shutoff speed default is set to 10 mph (16 km/h).

- Press the Field Speed Settings Adjust Button (located on the Settings Page).

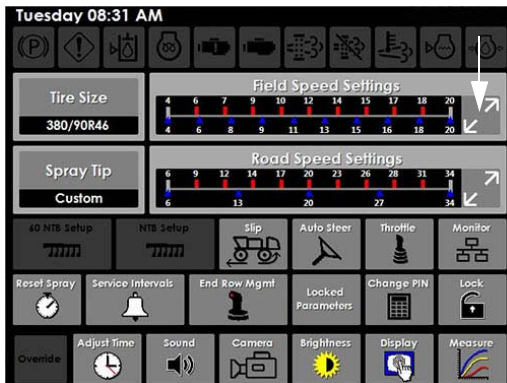

Field Speed Settings Adjust Button
(Located on the Settings Page)

- On the “Adjust Field Speed Settings” screen, press EDIT (next to AWS Shutoff Speed).

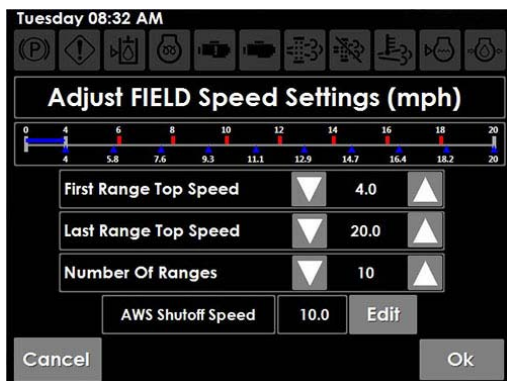

Adjust Field Speed Settings Screen

- Enter desired value.
- Press ACCEPT.
- Press OK.

Refer to “All-Wheel Steer” provided in the *Engine and Drive Systems Section* elsewhere in this manual for complete operating instructions and safety precautions.

Auto Steer

Steering Angle Sensor Absolute (SASA)

The absolute value of steering angle.

SASA T-Delay ON

Amount of time (in milliseconds) that the steering wheel must NOT move before Auto Steer will engage.

SASA T-Delay OFF

Amount of time (in milliseconds) that the steering must move before Auto Steer will disengage.

NOTE: Default is set to 70 ms (less than 0.1 seconds) for both delay On/Off modes.

A-Steer Sensitivity

How much the steering wheel must move to disable Auto Steer.

NOTE: A larger sensitivity number means that the steering wheel will need to be turned farther and faster for Auto Steer to disengage.

To Change Auto Steer Setting Values

- Press the Auto Steer Button (located on the Settings Page).

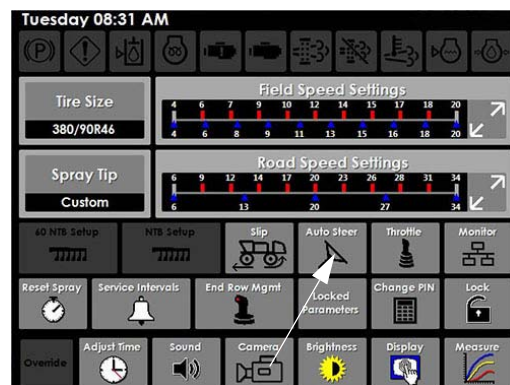

Auto Steer Button
(Located on the Settings Page)

- On the “Auto Steer” screen, press EDIT (next to the desired Auto Steer setting).

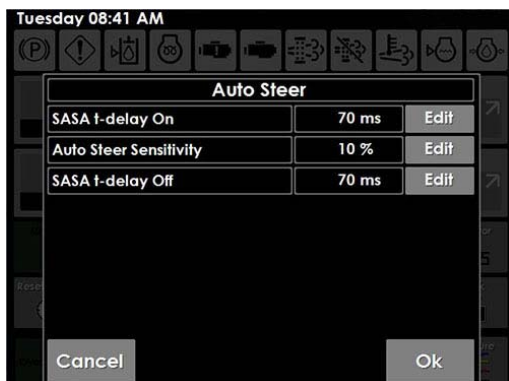

Auto Steer Screen

- On the “Adjust Slip Parameters” screen, press EDIT (next to Slip Percent).

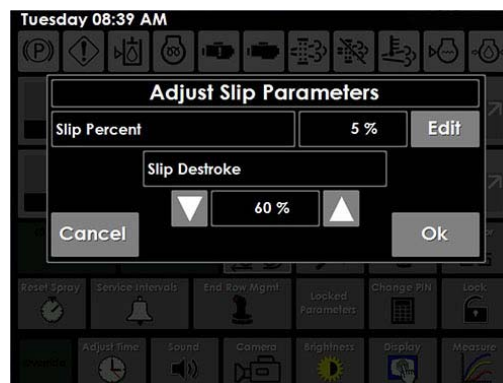

Adjust Slip Parameters Screen

- Enter new value, then press ACCEPT.
- Press OK.

Slip (Traction Control)

Slip Percent

How much slip is allowed before traction control is activated.

Slip Destroke

The percentage command that the wheel motors will ramp up to limit hydraulic flow.

NOTE: The higher the destroke number, the less the hydraulic flow will go to the slipping wheel motor.

To Adjust Slip Percent

- Press the Slip Button (located on the Settings Page).

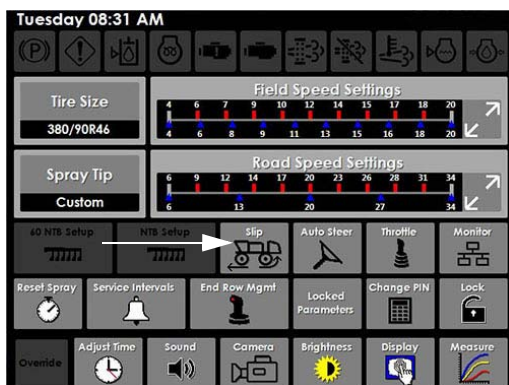

Slip Button
(Located on the Settings Page)

- Enter desired slip percentage value, then press OK.
- Press OK.

To Adjust Slip Destroke

- Press the Slip Button (located on the Settings Page).
- On the “Adjust Slip Parameters” screen, press the Up/Down Arrow Buttons to obtain desired destroke value.

NOTE: Slip Destroke values are available in 20-percent increments.

- Press OK.

End Row Management

The End Row Management Switch (located on the Hydrostatic Drive Control Handle) may be programmed for use of various functions, including All-Wheel Steer, Auto Steer, Master Spray, and NORAC® Enable.

To Program the End Row Management Switch

- Press the End Row Management Button (located on the Settings Page).

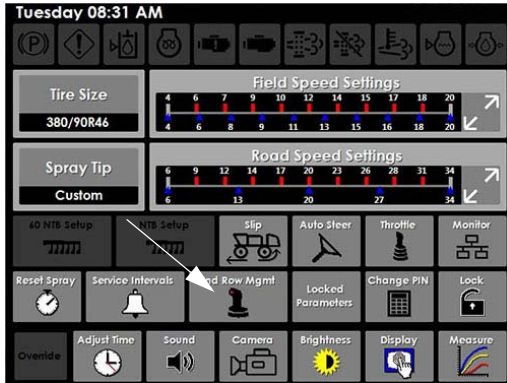

End Row Management Button
(Located on the Settings Page)

- On the “Select Action to Program” screen, select the setting in which you wish you operate the End Row Management Switch (located on the Hydrostatic Drive Control Handle) - “Single Press” or “Press and Hold”.



Select Action to Program Screen

- On the “End Row Management Editor” screen, press the “+” Button and select desired function (AWS, Auto Steer, Master Spray, or NORAC Enable).
- Press OK.

NOTE: Press the “-” Button to remove function.

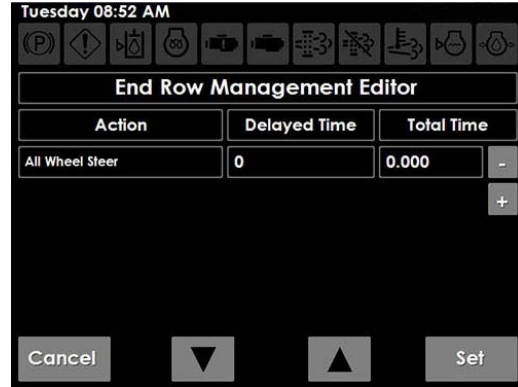

End Row Management Editor Screen

- Press SET.

Delayed Time and Total Time (Milliseconds)

Delayed Time

Press the “Delayed Time” display to adjust the time from when the End Row Management Switch (located on the Hydrostatic Drive Control Handle) is pressed to when the function is engaged.

Total Time

Displays the total time from when the End Row Management Switch is pressed until delayed time starts.

Example:

	Delayed Time	Total Time	Time from when ERM Button is pressed to engagement
1.	0	0	0
2.	500	0	500
3.	1,000	500	1,500
4.	0	1,500	1,500

Edit End Row Management Settings

- On the “Select Action to Program” screen, press the Edit Settings Button.
- On the “End Row Management Settings” screen, press EDIT (next to desired End Row Management setting).

- *Pause Before Activate*

- Display When Active
- Enable Single Press
- Enable Press and Hold

NOTE: If custom tire size is desired, press the Custom Button and enter tire rolling circumference accordingly.



End Row Management Settings Screen

- Enter desired value/setting, then press OK.
- Press OK.

Refer to “Spray Booms” provided in the *Spray Systems Section* elsewhere in this manual for information on setting up End Row Management NORAC Enable functions through the NORAC or Ag Leader display.

Tire Size

To Change Tire Size Value

- Press the Tire Size Button (located on the Settings Page).

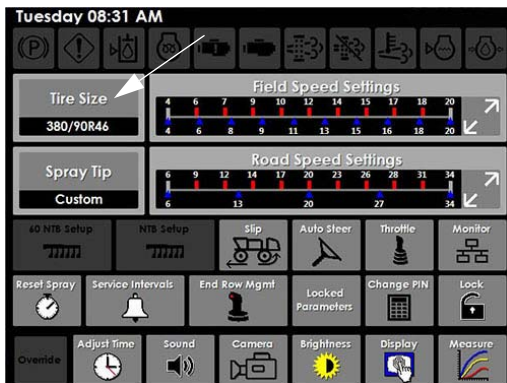

Tire Size Button
(Located on the Settings Page)

- On the “Tire Size” screen, select tire size.



Tire Size Screen

- Press OK.

Tread Width Adjustment

-If Equipped

Tread Width can be individually adjusted by pressing and holding the corresponding Tread Width Adjustment Button (located on the Auxiliary Controls Page) to desired position.

NOTE: Rear Left and Right Tread Width Indicators are displayed to the left of the Tread Width Adjustment Buttons.

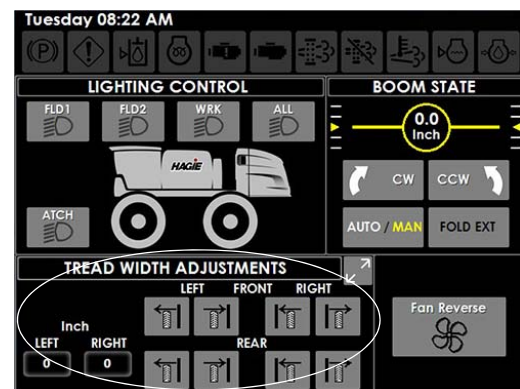

Tread Width Adjustment
Buttons/Indicators
(Located on the Auxiliary Controls Page)

To Adjust Multiple Tread Widths

- Press the Tread Page Button (located on the Auxiliary Controls Page).

NOTE: This button is marked with two arrows and will navigate to the Tread Adjustment Page.

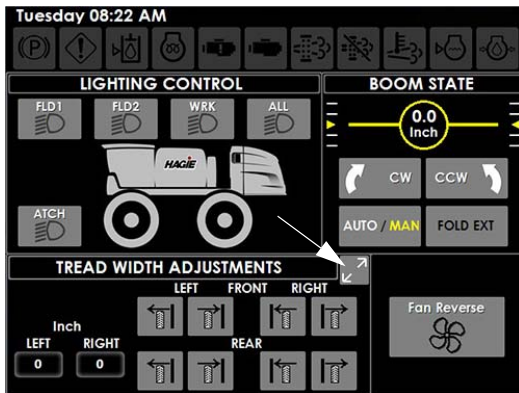

Tread Page Button

(Located on the Auxiliary Controls Page)

- On the Tread Adjustment Page, select the tread that you wish to simultaneously adjust by pressing the desired “wheel(s)” on the display screen.
- While driving one or two miles per hour (1.6 to 3.2 km/h), press and hold the IN or OUT Button until desired tread width is obtained.

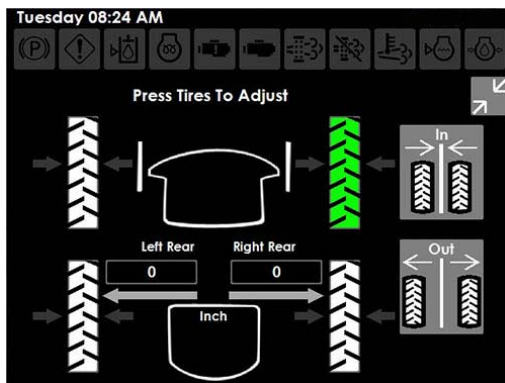

Tread Adjustment Page

NOTE: Press the Tread Page Button again to resume to the previous page.

Refer to the *Hydraulic Systems Section* elsewhere in this manual for further information.

System Gauges

(Engine Load, Fuel Rate, System Voltage)

Electronic System Gauges for machine Engine Load, Fuel Rate (gallons per hour), and System Voltage are located on the Machine Diagnostics Page. Digital display indicators are located beneath each System Gauge.

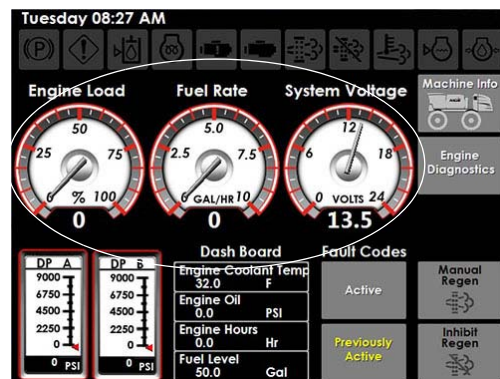

System Gauges

(Located on the Machine Diagnostics Page)

NOTE: When battery voltage depletes to 11.7 volts and below, a warning message will appear alerting you of low battery voltage.

System Diagnostics

System Diagnostics may be viewed on the Machine Diagnostics Page. Such items include:

- Engine Coolant Temperature
- Engine Oil Pressure
- Engine Hours
- Fuel Level

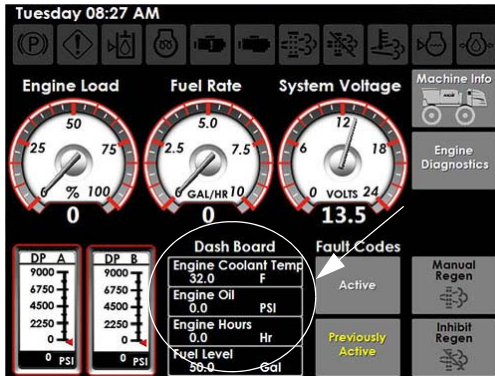

System Diagnostics
(Located on the
Machine Diagnostics Page)

When a service interval has been reached, a screen message will appear on the Machine Display informing you which service item requires attention.

Refer to the *Maintenance and Storage Section* elsewhere in this manual for information on recommended service intervals.

Engine Coolant Temperature

The Engine Coolant Temperature Gauge is located on the Machine Diagnostics Page. If the engine coolant temperature reaches a level that is too high (greater than 220° F.), a warning message will appear and a red indicator light will illuminate on the A-post temperature gauge. In addition, the warning buzzer will sound.

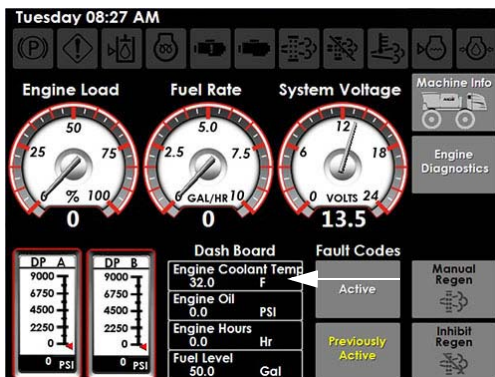

Engine Coolant Temperature Gauge
(Located on the
Machine Diagnostics Page)

NOTE: The warning buzzer may be silenced by pressing the Sound Button (located on the Settings Page).

If the engine temperature continues to rise after the initial warning message, a second warning message will appear shortly before the machine begins to go into protective mode, alerting you that the engine coolant temperature is too high and the engine will begin to de-rate. Press OK to acknowledge.

If this warning message appears, immediately reduce the engine speed and allow engine to idle. This will allow the cooling system to cool the engine down and prevent possible damage. Contact the Hagie Customer Support department if troubleshooting assistance is needed.

NOTE: When this warning message appears, the machine may be severely limited in engine and hydraulic functions (to prevent possible damage to those systems).

DP-A/DP-B Gauges

The DP-A and DP-B Gauges (located on the Machine Diagnostics Page) displays current drive pump pressure.

- **DP-A** (Drive Pump, Port A) - High in forward acceleration.
- **DP-B** (Drive Pump, Port B) - High in forward or reverse deceleration.

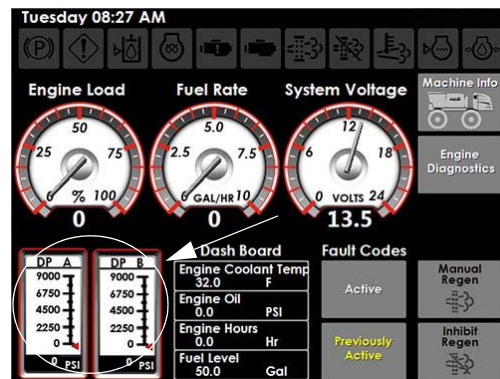

DP-A/DP-B Gauges
(Located on the
Machine Diagnostics Page)

Engine Diagnostics

To View Current Engine Diagnostics

- Press the Engine Diagnostics Button (located on the Machine Diagnostics Page).

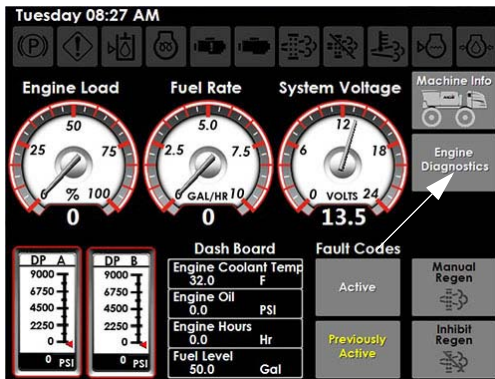

Engine Diagnostics Button
(Located on the
Machine Diagnostics Page)

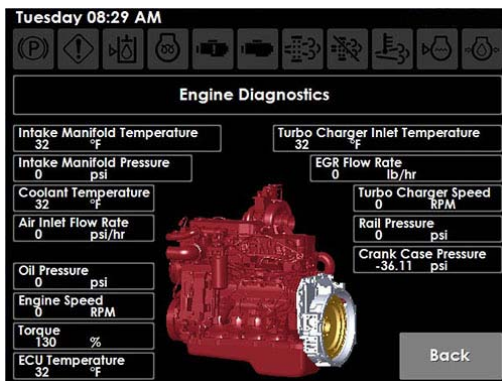

Engine Diagnostics Screen

Engine Shutdown Override (Tier 4 Final engines only)

NOTICE

The Engine Shutdown Override feature is not intended as means of avoiding an engine shutdown for an extended period of time.

The Override Engine Shutdown Button (located on the Machine Diagnostics Page) allows the operator to continue running the engine for a calibrated time period in order to move the vehicle to a safe stopping location.

To Temporarily Avoid Engine Shutdown (Derate)

- Press and hold the Override Engine Shutdown Button (located on the Machine Diagnostics Page) momentarily.

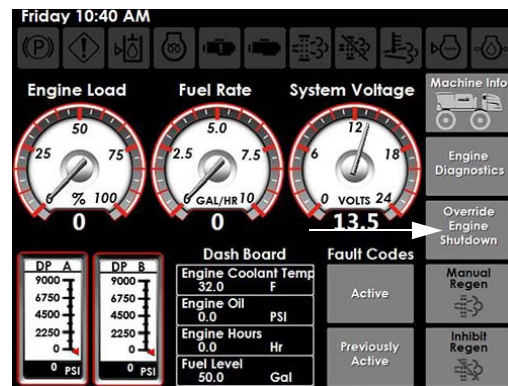

Override Engine Shutdown Button
(Located on the
Machine Diagnostics Page)

Refer to the engine manufacturer's operation manual for further information.

CAN Monitor (Controller Area Network)

The CAN Monitor on your machine is an analysis/communication tool used in combination with machine software, which allows you to view real-time data of machine systems. The CAN Monitor screen allows you to view CAN messages on each of the CAN networks.

CAN1/CAN2/CAN3

- CAN1 = Engine
- CAN2 = Primary/Secondary Controllers
- CAN3 = Diagnostics (Primary Controller)

NOTE: CAN3 by itself does not go to display and is CAN for third party systems.

Rx (Display Message “Received”)

Tx (Display Message “Transmitted”)

To View CAN Status

- Press the Monitor Button (located on the Settings Page).

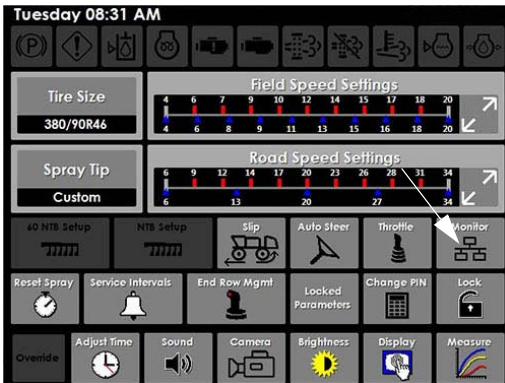

Monitor Button
(Located on the Settings Page)

- Press desired Enable CAN Button (Enable CAN1, Enable CAN2, or Enable CAN3) (located on the CAN Monitor screen) to view current CAN status.

NOTE: Press the Suppress Rx Button to remove “received” data before the Enable CAN Button is selected. Press the Suppress Tx Button to remove “transmitted” data before the Enable Can Button is selected.

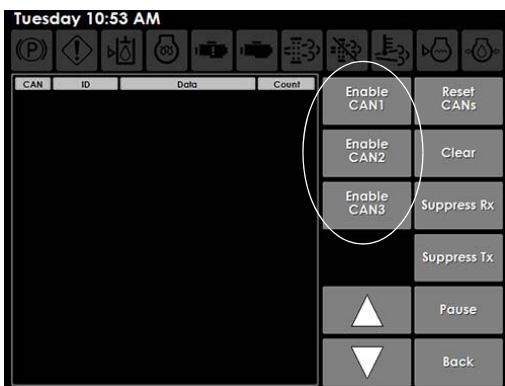

Enable CAN Buttons
(Located on the CAN Monitor Screen)

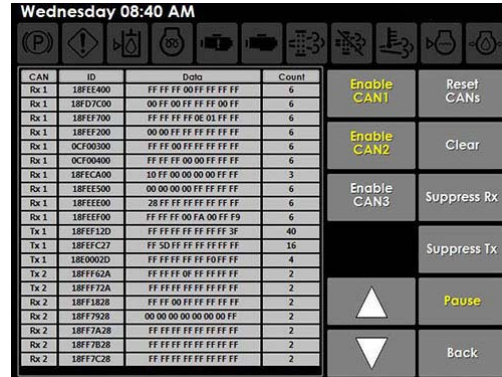

CAN Status

- Press the Pause Button at any time to pause the monitor.
- Press the Up or Down Arrow Buttons to navigate through the CAN pages individually.
- Press the Reset CANs Button to reset all CAN data.
- Press the Clear Button to clear the current screen.
- Press the Back Button to revert back to the Settings Page.

Measure

While either parked or operating the machine, current system measurements can be viewed when diagnosing or troubleshooting.

- Press the Measure Button (located on the Settings Page).

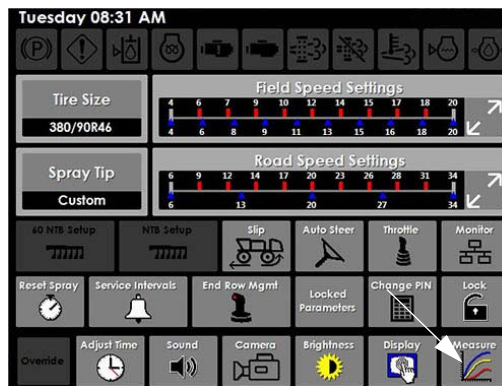

Measure Button
(Located on the Settings Page)

- Select system.

- On the “Press to Select Signals to Measure” screen, press the UP or DOWN Arrow Buttons to toggle to desired parameters.

NOTE: Single arrow buttons toggle up/down one page. Double arrow buttons toggle to either the first or last page.

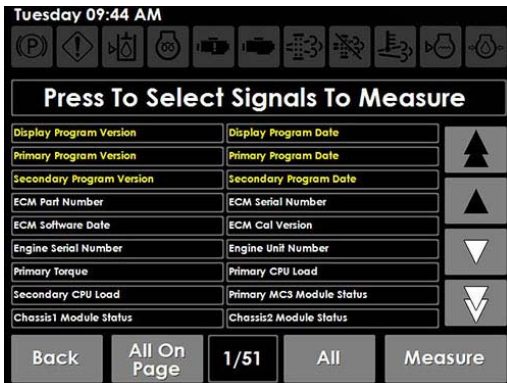

Press to Select Signals to Measure Screen

- Select desired system(s).
- NOTE: Multiple signals may be selected and viewed simultaneously.*
- Press MEASURE to view current signal measurements.

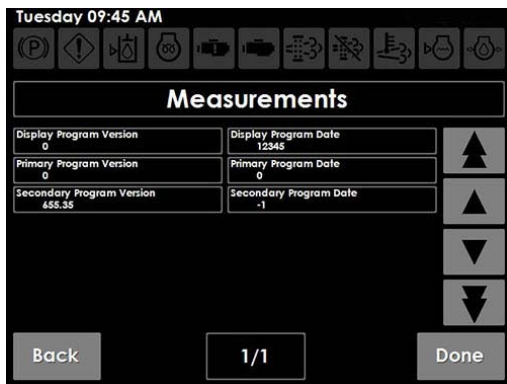

Measurement Screen

- Press BACK to revert to previous page and add or remove signals.
- Press DONE when finished.

System Faults

When a System Fault occurs, a warning message will appear on any given display page, which will inform you of the fault code and reason for the fault. Press OK to acknowledge.

System Faults can be viewed through the Machine Display. Refer to fault codes when speaking with a Hagie Customer Support representative.

Each System Fault will display the following:

- LAMP** (severity of fault)
 - Blue = Informational
 - Yellow = Caution
 - Red = Warning (shut down engine immediately)
- FAULT CODE** (refer to the fault code when speaking with a Hagie Customer Support representative)
- DESCRIPTION** (fault description)
- OCCURENCE** (number of fault occurrences)
- TIME** (time fault occurred)

To View System Faults:

- Press the desired “Active” or “Previously Active” Fault Code Button (located on Machine Diagnostics Page).

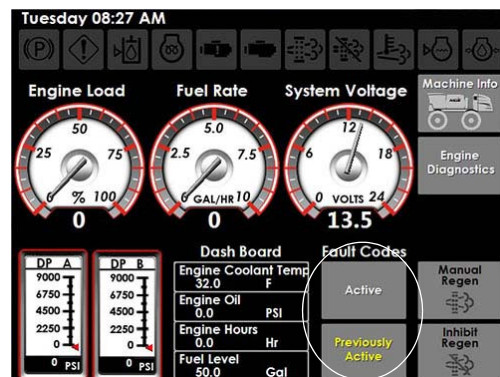

Fault Code Buttons
(Located on the Machine Diagnostics Page)

- On the “System Faults” screen, press the Up/Down Buttons to toggle to desired fault.

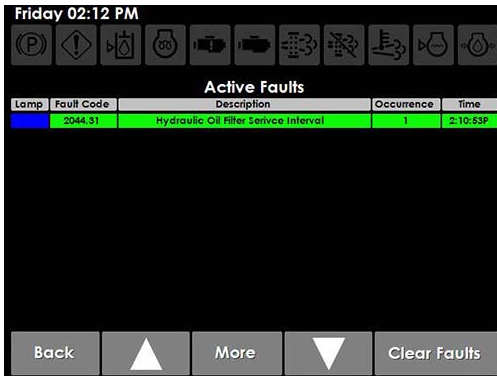

System Faults Screen

- Press the More Button to display fault description.
- Press the Clear Faults Button to remove faults after the fault issue has been resolved.
- Press OK to confirm.

NOTE: System Faults will continue to appear until the fault issue has been resolved, regardless of clearing the faults.

In the event that a severe system malfunction should occur and cause the machine to operate outside of normal operating conditions (e.g. All-Wheel Steer fault, Hydrostatic Drive Control Handle not in neutral but has no y-axis position, tire size not selected, etc.), a Machine Fault Warning message will appear on the display. This warning message will inform you that a malfunction was detected and that the machine is not responding normally and you must operate with extreme caution, as machine speed will be limited and stopping distance may be increased or decreased. Press OK to acknowledge.

In addition, a second warning message will appear informing you of the specific fault description. Contact Hagie Customer Support for assistance.

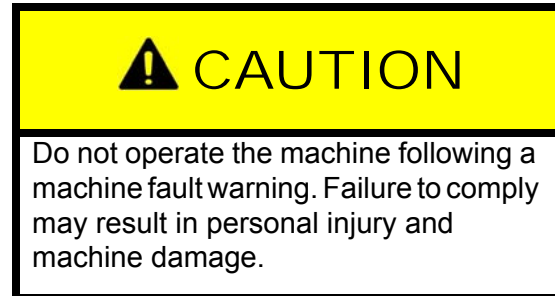

Machine Fault Warning

Reversible Fan

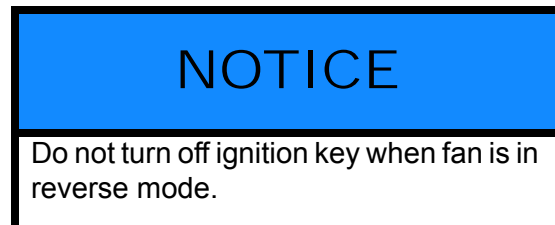

To Activate the Reversible Fan

- Press the Reversible Fan Button (located on the Auxiliary Controls Page).

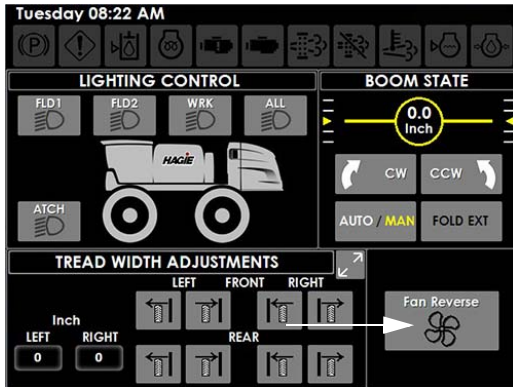

Reversible Fan Button
(Located on the Auxiliary Controls Page)

- On the “Engine Fan Control” screen, press REVERSE to turn the fan ON (reverse).

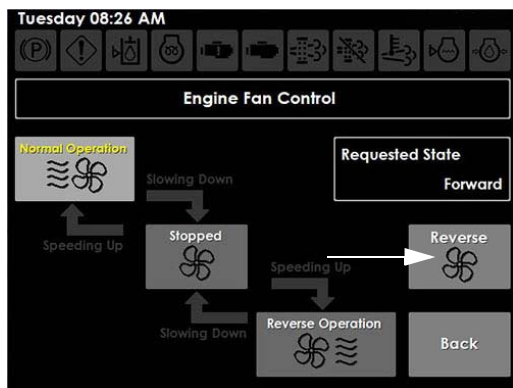

Engine Fan Control Screen

NOTE: During the reverse cycle, the “Engine Fan Control” screen will display the current state of the reversible fan (Normal Operation, Stopped, or Reverse Operation) and will let you know if the fan is slowing down or speeding up. The fan will automatically return to Normal Operation when the reverse cycle is complete.

Refer to “Reversible Fan” provided in the *Hydraulic Systems Section* elsewhere in this manual for further information.

Spray System Indicators

- Rinse Mode Indicator
- Solution Pump Indicator
- Master Spray Indicator



- Agitation Valve Pressure Indicator
- Main Tank Valve Indicator
- Droplet Size Indicator

Spray System Indicators
(Located on the Home Page - Field Mode)

Solution Pump Indicator

When the Solution Pump Switch (located on the side console) is turned ON, a Solution Pump Indicator (located on the Home Page - Field Mode) will illuminate.

NOTE: When the Solution Pump Switch and the Manual (MAN) Rate Control Switch (located on the side console) are both enabled, the pump speed is displayed below the Solution Pump Indicator. Press the “+” or “-” Pump Speed/Rate Switch (located on the side console) to increase or decrease solution pump speed.

Master Spray Indicator

When the Master Spray Switch (located on the Hydrostatic Drive Control Handle) has been activated, a Master Spray Indicator (located on the Home Page - Field Mode) will illuminate.

Main Tank Valve Indicator

When the Main Tank Valve Switch (located on the side console) is activated, the Main Tank Valve Indicator (located on the Home Page - Field Mode) will display

OPEN. When the switch is not activated, the Main Tank Valve Indicator will display CLOSED.

Rinse Mode Indicator

When the Rinse Switch (located on the side console) is activated, the Rinse Mode Indicator (located on the Home Page - Field Mode) will display either OFF, BOOM, or TANK.

Agitation Valve Pressure Indicator

The Agitation Valve Switch (located on the side console) controls the rate of flow through the Agitation System. Agitation pressure is displayed on the Home Page - Road and Field Mode.

Droplet Size Indicator

The Droplet Size Indicator (located on the Home Page - Field Mode) displays droplet size based on spray tip size and pressure.

Drop Size Classification:

- **XF** - Extra Fine
- **VF** - Very Fine
- **F** - Fine
- **M** - Medium
- **C** - Coarse
- **VC** - Very Coarse
- **XC** - Extra Coarse
- **UC** - Ultra Coarse

NOTE: Current solution operating pressure is displayed below the Droplet Size Indicator.

Refer to the *Spray Systems Section* elsewhere in this manual for further information.

Spray Booms

Boom State - Auto/Manual (120'/132' Spray Booms)

Press the Boom State Button (located on the Auxiliary Controls Page) to the AUTO or MANUAL position.

NOTE: The selected boom state will illuminate.

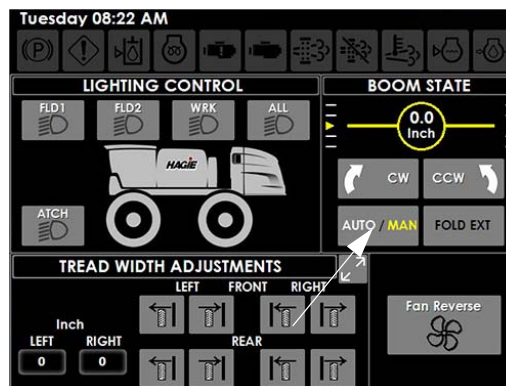

Boom State Buttons - Auto/Manual
(Located on the Auxiliary Controls Page)

Boom Extensions - Auto Fold

To operate the Boom Extensions in Auto mode:

- Press the Boom State Button (located on the Auxiliary Controls Page) to the AUTO (illuminated) position.
- Press the Fold Ext Button (located on the Auxiliary Controls Page) to the ON (illuminated) position to enable Auto Fold operation.

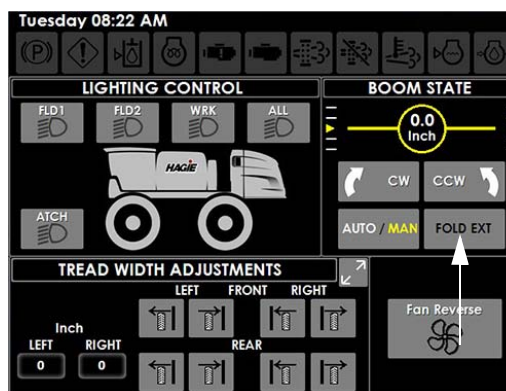

Fold Extension Button
(Located on the Auxiliary Controls Page)

- Operate the Left and Right Boom Extension Switches (located on the side console) to desired position.

Refer to the *Spray Systems Section* elsewhere in this manual for further information.

Boom Alignment (120’/132’ Spray Booms)

When operating boom functions, the Boom Alignment value may be viewed on the Auxiliary Controls Page.

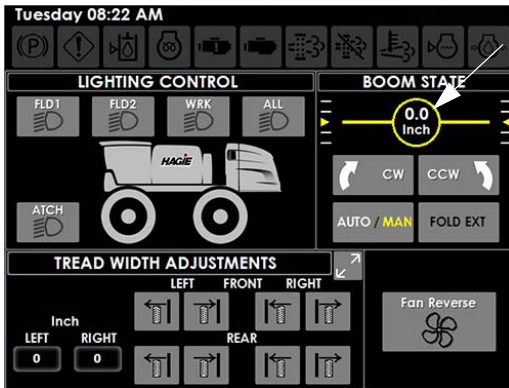

Boom Alignment Value
(Located on the Auxiliary Controls Page)

Rolling Boom (120’/132’ Spray Booms)

The Roll Command Buttons (located on the Auxiliary Controls Page) will enable the boom to roll either “clockwise” or “counter-clockwise” (as viewed from the cab).

- Press and hold the “CW” Roll Command Button to roll the boom “clockwise”.
- Press and hold the “CCW” Roll Command Button to roll the boom “counter-clockwise”.

NOTE: The Roll Command Buttons will illuminate when held in the ON position and the current boom alignment value will be displayed.

- When either of the CW or CCW Roll Command Buttons are released, the boom will return to the neutral (center) position.

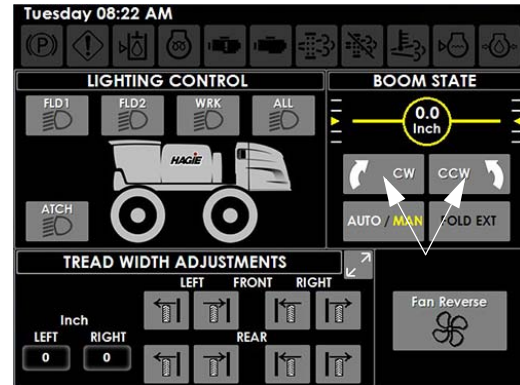

Roll Command Buttons (CW/CCW)
(Located on the Auxiliary Controls Page)

NOTE: Center position value is 0 inches/cm.

Refer to the *Spray Systems Section* elsewhere in this manual for further information.

Spray Tip Selection

To Change Spray Tip Size

- Press the Spray Tip Button (located on the Settings Page).

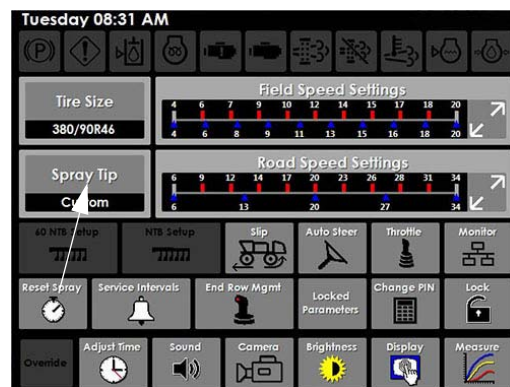

Spray Tip Button
(Located on the Settings Page)

- On the “Spray Tip” screen, select the first part of desired spray tip.

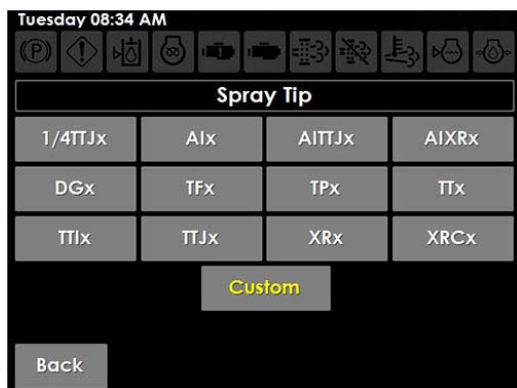

Spray Tip Screen

- Select the corresponding spray tip size.
- Press OK.

Custom Spray Tip Selection

- Press the Spray Tip Button (located on the Settings Page).
- On the “Spray Tip” screen, press the Custom Button.
- On the “Press to Select Droplet Size(s)” screen, select desired droplet size ranges.

NOTE: Droplet size ranges may be selected by pressing each droplet size individually, or by pressing and dragging desired selections.

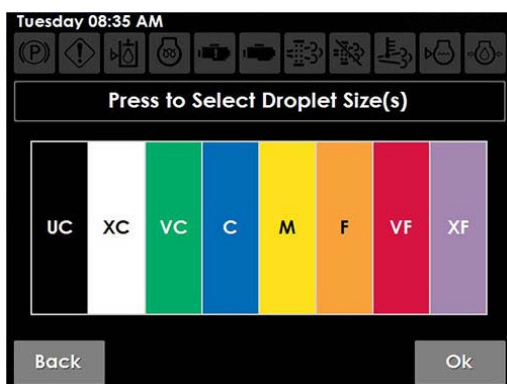

Press to Select Droplet Size(s) Screen

- Press OK.
- On the “Enter Pressures for Selected Droplet” screen, navigate to desired droplet size indicator (previously selected) using the Left/Right Arrow Buttons.

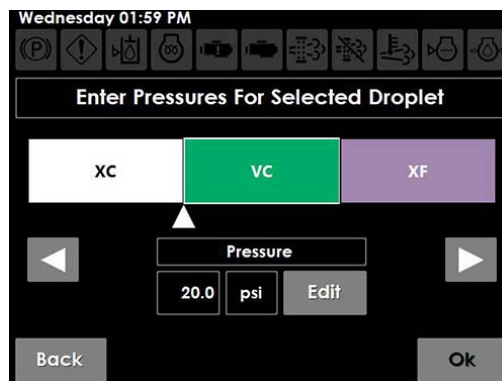

Enter Pressure for Selected Droplet Screen

- When the corresponding droplet size indicator is selected, press EDIT.
- Enter desired pressure value (break-point), then press OK.

NOTE: Enter desired pressure value for each droplet size indicator selected.

- Press OK.

Refer to the *Spray Systems Section* elsewhere in this manual for further information.

Refer to your spray product catalog for recommended spray tip psi/bar.

Spray Time Indicators

Spray Application Time

The current amount of spray application time is displayed on the bottom of the Home Page - Field Mode.

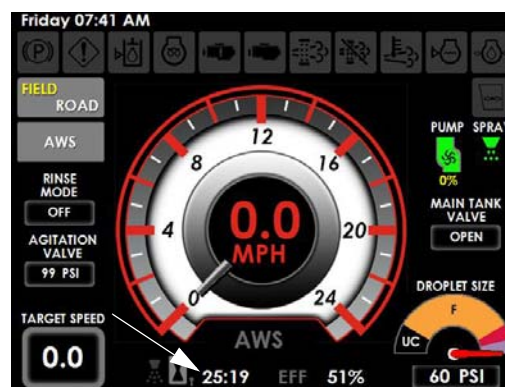

Spray Application Time Indicator
(Located on the Home Page - Field Mode)

Efficiency (EFF) Rate

The EFF Rate (located on the bottom of the Home Page - Field Mode) displays the current spray efficiency value (Spray time divided by the time spent in Field Mode).



Efficiency (EFF) Rate
(Located on the Home Page - Field Mode)

Reset Total Spray Time

- Press the Reset Spray Button (located on the Settings Page) to reset the total spray time and efficiency rate.

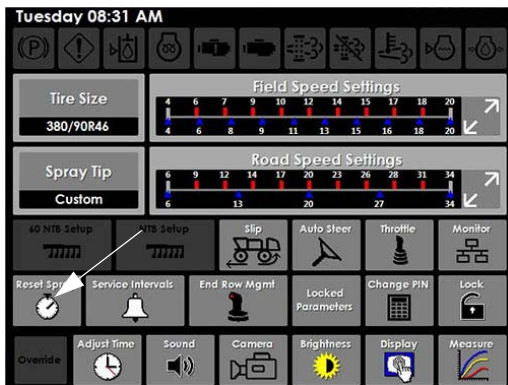

Reset Spray Button
(Located on the Settings Page)

- Press OK.

Nitrogen Toolbar (NTB)

-If Equipped

Float

The Float Button (located on the Auxiliary Controls Page) is used to enable Float operation.

- Press the Float Button to turn Float ON. Press button again to turn Float OFF.

NOTE: The Float Button will illuminate when in the ON position.

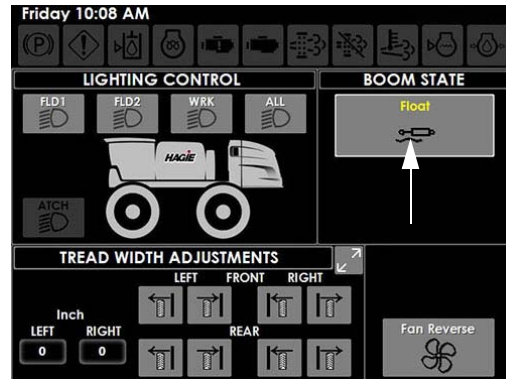

Float Button
(Located on the Auxiliary Controls Page)

NOTE: When Float operation is enabled on a 60-ft. NTB, a warning message (cradle hazard) will appear stating that before Float will be activated, ensure the NTB is in the UNFOLDED position. Press “Acknowledge” to accept.



Float Warning Message
(60' NTB only)

30'/40' NTB Setup

- Press the NTB Setup Button (located on the Settings Page).

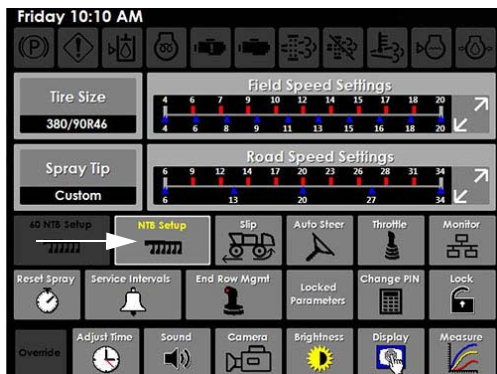

NTB Setup Button
(Located on the Settings Page)
-Typical View

- On the “NTB Adjustments” screen, press EDIT (next to desired selection - *NTB Override Timer, Float with Transom Down, or One Tap Transom Up*).

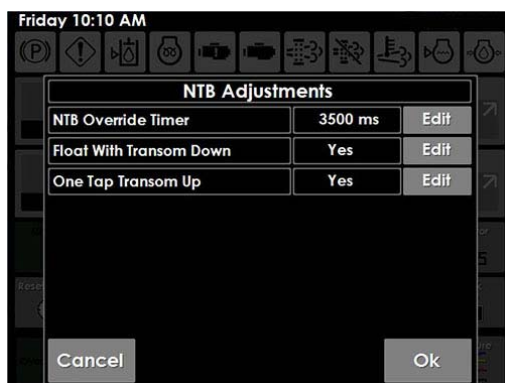

NTB Adjustments Screen

- Enter/select desired setting, then press OK.
- Press OK.

60' NTB Setup

Various 60-ft. NTB adjustments can be made through the Machine Display to allow the tool bar to ride through the field and apply as desired with adjustable up/down functions to allow the operator to choose the depth in which the NTB will operate in Float mode.

- Press the 60' NTB Setup Button (located on the Settings Page).

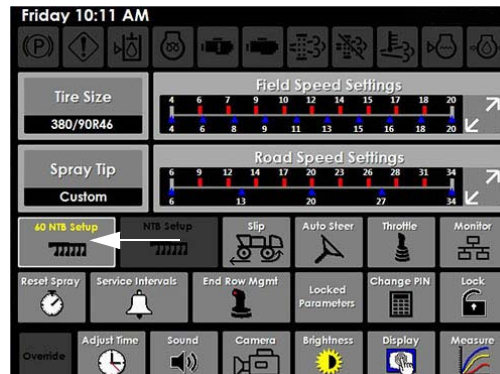

60' NTB Setup Button
(Located on the Settings Page)
-Typical View

- On the “60' NTB Adjustments” screen, press EDIT (next to desired selection - *Main Lift Maximum, Left Section 3 Maximum, Left Section 2 Maximum, Right Section 3 Maximum, Right Section 2 Maximum, Section 1 Force Float*).

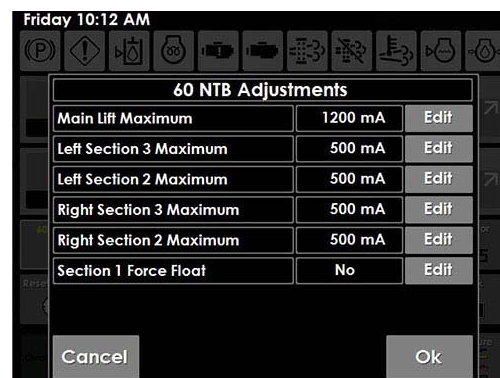

60' NTB Adjustments Screen
-Typical View

- Enter/select desired setting, then press OK.
- Press OK.

Further Information

Refer to your NTB operator’s manual for complete feature descriptions and operating instructions.

SECTION 4 – ENGINE AND DRIVE SYSTEMS

WARNING

**CALIFORNIA PROPOSITION
65 WARNING**

WARNING: Diesel engine exhaust and some of its constituents are known to the State of California to cause cancer and birth defects or other reproductive harm.

WARNING: Battery posts, terminals, and related accessories contain lead and lead compounds, and chemicals known to the State of California to cause cancer and birth defects or other reproductive harm.

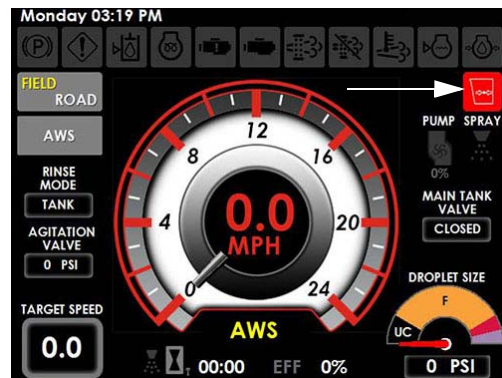

Insufficient Cab Air Pressure Indicator
(Located on the Machine Display Home Page - Road or Field Mode)

Pre-Operational Checklist

1. Check engine oil level.

NOTE: Do not operate the machine when oil level is below the “L” (low) mark or above the “H” (high) mark on the engine oil dipstick.

2. Check coolant level.
3. Check diesel exhaust fluid level (Tier 4 Final engines only).
4. Check hydraulic reservoir oil level.
5. Check cooling air intake screen.
6. Drain fuel/water separator.
7. Check engine drive belt.
8. Drain water out of the air tank.
9. Check for any oil or fuel leaks.

Cold Start Procedure

1. Engage the parking brake.

NOTE: Refer to “Hydrostatic Drive” provided elsewhere in this section for further information.

2. Turn the Ignition ON, but DO NOT engage the starter. (**Wait for the Grid Heater ON indicator to disappear on the Machine Display**).

The following warning message will appear on the Machine Display during cold weather

ENGINE - STARTING

CAUTION

Start engine from the operator’s seat only. When running the engine in a building, ensure there is adequate ventilation.

NOTE: An Insufficient Cab Air Pressure Indicator will appear on the Machine Display Home Page - Road or Field Mode each time the machine is started, due to a slight activation delay of the RESPA® Cab Filtration System. The indicator will disappear once the cab becomes pressurized.

conditions. Press OK (acknowledging that you understand the engine requires a warm-up period before engaging the starter).



NOTE: Ensure that there are no other warnings before proceeding.

- Engage the starter.
(If the engine fails to start after 15 seconds, turn the key OFF, wait one minute, and repeat the procedure. If the engine does not start after three attempts, check the fuel supply system).

NOTE: Absence of blue or white exhaust smoke while cranking indicates that no fuel is being delivered.

- Observe warning lights on the Machine Display (after start-up).

NOTE: If any functions do not operate, shut the engine OFF and determine cause.

- Allow a warm-up period of at least five (5) minutes before operating the engine at a high RPM.

NOTE: The engine must reach operating temperature and oil pressure must stabilize in the normal operating range before it is run faster than idle speed (1,000 RPM or less).

- Disengage the parking brake.

Jump Starting

- Engage the parking brake.

- Rotate the Battery Disconnect Switch (located on the rear mainframe) to the ON position.



Battery Disconnect Switch
(Located on the rear mainframe)
-Typical View

- Remove caps from the Auxiliary Battery Charging Posts (located on the rear mainframe).



Auxiliary Battery Charging Posts
(Located on the rear mainframe)
-Typical View

- Connect cables from charging device (i.e. battery charger or another machine) to the Auxiliary Battery Charging Posts - positive cable to the positive terminal, and negative cable to the negative terminal.
- Allow batteries to charge approximately 5-10 minutes.

NOTICE

Do not over-crank the starter. Failure to comply may result in starter damage.

6. Engage the starter by starting the machine.
7. Remove the charging cables in reverse to the way you attached them (negative cable first, then positive cable).

NOTE: Ensure that the charging cables do not touch together or to any metal surface.

8. Reinstall the Auxiliary Battery Charging Post caps.
9. Allow engine to idle for approximately 5 minutes to recharge the batteries.

NOTE: Longer idle time may be required, depending on how depleted the batteries are.

ENGINE AFTERTREATMENT - TIER 4 FINAL

-If Equipped

WARNING

It is unlawful to tamper with or remove any component of the Aftertreatment System. It is also unlawful to use Diesel Exhaust Fluid (DEF) that does not meet the specifications provided or to operate the machine with no DEF.

WARNING

DEF contains urea. Do not get the substance in your eyes. In case of contact, immediately flush eyes with large amounts of water for a minimum of 15 minutes. Do not swallow internally. In the event the DEF is ingested, contact a physician immediately.

WARNING

Read the DEF manufacturer's label and comply with safety precautions to avoid injury or damage.

CAUTION

Never attempt to create DEF by mixing agricultural grade urea with water. Agricultural grade urea does not meet the necessary specifications required and the Aftertreatment System may be damaged.

CAUTION

Aftertreatment DOC and DRT components may be hot. Allow engine to cool before handling. Failure to comply may result in injury.

CAUTION

Never add water or any other fluid besides what is specified to the DEF tank. Failure to comply may result in Aftertreatment System damage.

CAUTION

Do NOT add any chemicals/additives to the DEF in an effort to prevent freezing. If chemicals/additives are added to the DEF, the Aftertreatment System may become damaged.

CAUTION

When performing a stationary exhaust system cleaning, ensure the exhaust pipe outlet is not directed at any surface or material that may become hazardous.

NOTICE

USE CORRECT FLUID TYPES

- Use only low-ash diesel engine oil.
- Use only ultra-low sulfur diesel (ULSD) fuel.
- Use only DEF meeting ISO 2224101 standards.

Failure to use the required fluid types will result in engine damage and will void the warranty.

NOTICE

Never operate the engine with low DEF level.

NOTICE

Do not direct water into exhaust opening. Failure to comply may result in system damage and will void the warranty.

NOTICE

DEF CAN BE CORROSIVE TO CERTAIN MATERIALS

- Use only approved containers to transport or store DEF (polyethylene and polypropylene containers recommended).
- If DEF is spilled, rinse and clean immediately with water.
- Avoid contact with skin. If contact occurs, wash off immediately with soap and water.

NOTICE

Wipe up spills immediately with clean water. If DEF is left to dry, a white residue will remain. Failure to clean spilled DEF appropriately may result in an incorrectly diagnosed leak of the DEF Dosing System.

NOTICE

Thoroughly wash any containers, funnels, etc. that will be used to dispense, handle, or store DEF. **Rinse with distilled water only.** Use of tap water to rinse components will contaminate the DEF.

NOTICE

If incorrect fluid is mistakenly added to the DEF tank (e.g. water, diesel fuel, hydraulic oil, engine coolant, windshield washer fluid, etc.), contact the engine manufacturer to determine the appropriate repair.

The Tier 4 Final diesel engine is featured with a flow-through exhaust Aftertreatment System that delivers ultra-low emissions for cleaner air quality.

NOTE: When the ignition key is turned to the OFF position, DEF returns to the DEF tank.

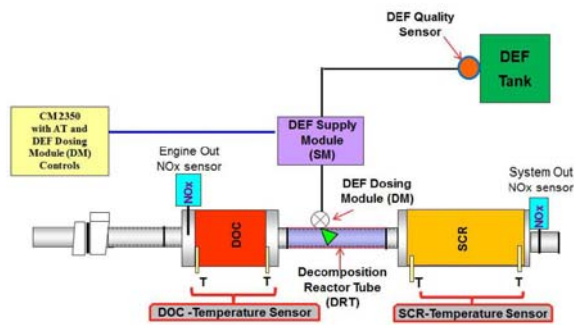

Engine Aftertreatment System

Aftertreatment System Components

- Tier 4 Final Diesel Engine
- Diesel Exhaust Fluid (DEF) Tank
- Diesel Exhaust Fluid (DEF) Gauge
- Diesel Oxidation Catalyst (DOC)
- Decomposition Reactor Tube (DRT)
- Selective Catalytic Reduction (SCR)
- DEF Dosing Module
- DEF Supply Module
- DEF Supply Module Filter
- DEF Quality Sensor
- DEF Suction Strainer

Tier 4 Final Diesel Engine



Tier 4 Final Diesel Engine
(Located near rear of machine
- open hood to access)
-Typical View

DEF Tank

- DEF Tank Capacity = 10 Gallons (37 L)

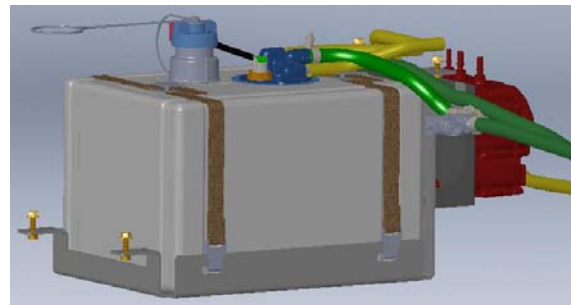

DEF Tank
(Located beneath center of machine)
-Typical View

DEF (Diesel Exhaust Fluid)

DEF is used in Selective Catalyst Reduction (SCR) Systems to help convert nitrogen oxide (NO_x) emissions in engine diesel exhaust into harmless nitrogen and water vapor.

NOTE: Check DEF level daily.

Fluid Type:

- Use only DEF which meet ISO 2224101 standards.

Fluid Storage:

- Store DEF between 23° F (-5° C) and 77° F (25° C).

- Refer to “Service - Fluids” provided in the *Maintenance and Storage Section* elsewhere in this manual for additional information.

Fluid Disposal:

- Check with local authority regulations on proper DEF disposal requirements.

DEF Gauge

The DEF Gauge (located on the cab A-post) allows the operator to view current DEF tank level at all times.



DEF Gauge
(Located on cab A-post)
-Typical View

DOC (Diesel Oxidation Catalyst)

The DOC reduces carbon monoxide and hydrocarbons produced by the engine.

DRT (Decomposition Reactor Tube)

The DRT is a mixer tube where DEF is injected and mixes with exhaust from the diesel engine, which is then converted into ammonia.

SCR (Selective Catalytic Reduction)

The SCR is where the DEF reduces gaseous nitrogen oxide (NOx) to near zero levels by converting into nitrogen gas and water vapor.

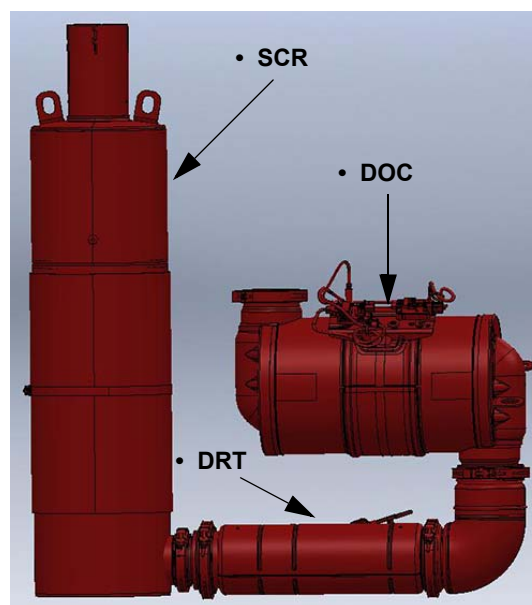

-Typical View

DEF Dosing Module

The DEF Dosing Module allows a fine mist of DEF to be sprayed into the hot exhaust.

DEF Supply Module

The DEF Supply Module pumps DEF from the tank to the Dosing Injector (located in the DRT).

DEF Supply Module Filter

The DEF Supply Module Filter (located near the bottom of the DEF Supply Module) filters DEF before going to the Dosing Injector. Change filter every 4,500 hours of operation or every 3 years, whichever occurs first.

NOTE: Refer to the engine manufacturer's operation manual for further information.

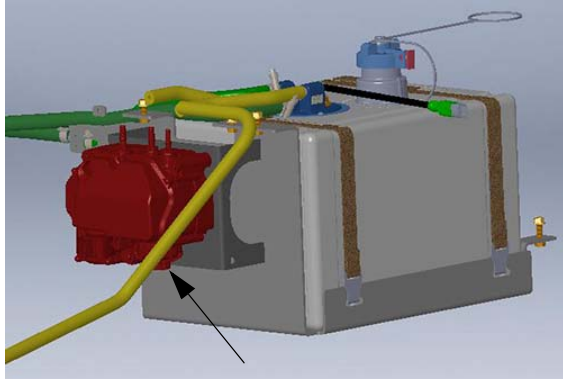

DEF Supply Module Filter
(Located near the bottom
of the DEF Supply Module)
-Typical View

DEF Quality Sensor

The DEF Quality Sensor (located inside the tank) detects DEF tank level, as well as quality and temperature of the DEF, which are required for the Aftertreatment System to function properly.

DEF Suction Strainer

The DEF Tank is equipped with a Suction Strainer (located near bottom of tank). If degraded system performance occurs, remove drain plug (located at bottom of tank) to drain sediment from tank. Remove and clean Suction Strainer, ensuring the strainer is reinstalled correctly when finished.

NOTE: Flush DEF Tank and components with distilled water only to remove any contamination. Refer to the engine manufacturer's operation manual for further information.

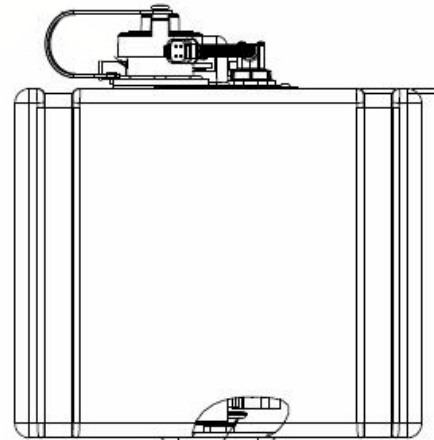

- DEF Suction Strainer
- DEF Tank Drain Plug

DEF Suction Strainer and Drain Plug
(Located near bottom of the DEF Tank)
-Typical View

Filling the DEF Tank

DEF Indicator Lamps

(Located on the Machine Display)



- **DEF Indicator Lamp** - Illuminates when the DEF level is low, and flashes when the DEF falls below a very low level. Operator should refill the DEF tank with DEF.



- **Flashing DEF Indicator Lamp with Check Engine Indicator Lamp** - Illuminates when the DEF level is critically low. If the tank is not refilled immediately, power will be reduced. Operator should refill the DEF tank with DEF. Normal engine power will be restored after the DEF tank is refilled.



- **Flashing DEF Indicator Lamp with Stop Engine Indicator Lamp** - Illuminates when the DEF gauge reads zero. Power will be reduced or limited to idle. Operator should stop the machine when it is safe to do so and refill the DEF tank. Normal engine power will be restored once the DEF tank is refilled.



1. Shut the engine OFF.
2. Lift the DEF Fill Access Panel (located near center platform behind solution tank).
3. Remove DEF Fill Cap and set aside.



DEF Fill Cap

(Located beneath center platform behind solution tank - lift panel to access)

-Typical View

4. Fill tank with DEF.
5. Reinstall DEF Fill Cap.

NOTE: Refill tank with DEF every other fuel fill.

6. Close DEF Fill Access Panel.

Stationary Exhaust System Cleaning

Your Tier 4 Final diesel engine requires little or no operator interaction. Under certain circumstances, an operator-initiated Exhaust System Cleaning may be required. Exhaust System Cleaning Indicator Lamps (located on the Machine Display) will illuminate to show system status.

Exhaust System Cleaning Indicator Lamps

(Located on the Machine Display)



ON

- **High Exhaust System Temperature (HEST) Indicator Lamp** - May illuminate due to higher than normal exhaust temperature during Exhaust System Cleaning. Operator should ensure that the exhaust pipe outlet is not directed at any flammable or combustible surfaces.



ON

- **Exhaust System Cleaning Indicator Lamp** - Illuminates when the exhaust system is unable to complete an automatic Exhaust System Cleaning event. Operator should ensure that the Exhaust System Cleaning Switch is not in the STOP position and continue working until there is an opportunity, such as at the end of the work day or shift to complete a stationary Exhaust System Cleaning.



ON

- **Exhaust System Cleaning Indicator Lamp with Check Engine Indicator Lamp** - If an Exhaust System Cleaning is not performed in a timely manner after the Exhaust System Cleaning Indicator Lamp is illuminated, the Check Engine Indicator Lamp will illuminate and engine power will be significantly reduced. Park the machine when safe to do so and press the Exhaust System Cleaning Start Switch. Once cleaning is complete, full engine power will be restored.



FLASHING

- **Exhaust System Cleaning Indicator Lamp** - Flashes when a stationary Exhaust System Cleaning event is initiated using the Exhaust System Cleaning Start Switch. This lamp will continue to flash until the stationary cleaning event is complete. Once the lamp turns off, the operator can resume normal operation.

Exhaust System Cleaning Indicator Lamps (Continued)



ON

- **Exhaust System Cleaning Stop Indicator Lamp** - Illuminates when the Exhaust System Cleaning Switch is in the STOP position, preventing a cleaning event. This switch should be used only when high exhaust temperatures present a hazard. Excessive use of the Exhaust System Cleaning Switch in the STOP position will result in the need for more frequent stationary exhaust cleaning events.



ON

- **Stop Engine Indicator Lamp (if equipped)** - Illuminates when continued operation could result in damage to the exhaust system. Shut down the engine as soon as it is safe to do so and call for service to avoid damage to the exhaust system.

To Perform an Exhaust System Cleaning

1. Park the machine in a safe location where the exhaust pipe outlet will not face any combustible surface.
2. Engage the parking brake.
3. With the engine running and at idle, press the Manual Regen Button (located on the Machine Display - Machine Diagnostics Page).

NOTE: When the cleaning event is activated, engine speed may increase and the HEST Indicator Lamp (located on the Machine Display) may illuminate and the Exhaust System Cleaning Indicator Lamp will flash.

4. Monitor the machine and surrounding area for safety.

NOTE: If the machine needs to be used or moved, stop the stationary cleaning event by increasing the Throttle Switch (located near the Hydrostatic Drive Control Handle).

5. When the Exhaust System Cleaning is complete, the engine will return to normal idle speed and the HEST and

Exhaust System Cleaning Indicator
Lamps will turn off.

Further Information

Refer to the *Maintenance and Storage Section* provided elsewhere in this manual for additional Aftertreatment service and maintenance information.

Refer to the engine manufacturer's operation manual for complete operating instructions and safety precautions.



Tier 3 Diesel Engine
-Typical View

HYDROSTATIC DRIVE

The Hydrostatic Drive System uses pressurized hydraulic fluid to drive the machine. The Hydrostatic Drive System consists of four components: Diesel Engine, Hydrostatic Pump, Wheel Motors, and Wheel Hubs.

Hydrostatic Drive Components

- Cummins® Diesel Engine
- Hydrostatic Pump
- Wheel Motors (4)
- Wheel Hubs (4)

Engine and Hydrostatic Pump

Your machine is featured with a Cummins diesel engine (located beneath the rear hood). The engine has a direct-mounted Hydrostatic Pump (located near center of machine).



Tier 4 Final Diesel Engine
-Typical View

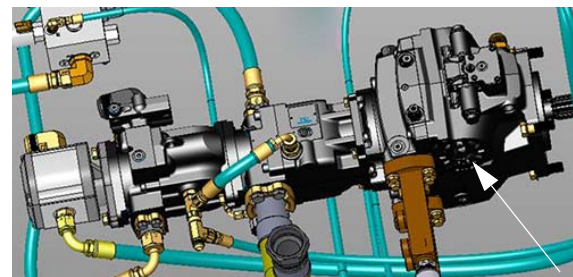

Hydrostatic Pump (Drive Pump)
-Typical View
(Viewed from top of machine)

Wheel Motors and Hubs

The drive system consists of hydraulic Wheel Motors and Gear Reduction Hubs (Wheel Hubs) located on each wheel.



Wheel Motor
-Typical View



Wheel Hub
-Typical View

Parking Brake

The Parking Brake will engage when applied hydraulic pressure falls below 150 PSI (10.3 bar) or if the engine is shut off.

CAUTION

Do not engage the parking brake while the machine is moving. Failure to comply may result in personal injury and machine damage.

NOTICE

The parking brake is not intended for normal or emergency stopping.

NOTE: Bring the machine to a complete stop before engaging the Parking Brake.

The Parking Brake also controls the Ladder. When the Parking Brake is engaged, the Ladder will extend (lower). When the Parking Brake is disengaged, the Ladder will retract (raise).

To Engage the Parking Brake

NOTE: Your machine is equipped with either Version 1 or Version 2 of the Hydrostatic Drive Control Handle. In addition to difference in the placement of controls, Version 1 allows the Parking Brake to engage/disengage through the Hydrostatic Drive Control Handle (moving the handle fully to the right). For machines equipped with Version 2, a separate parking brake switch is located adjacent to the Hydrostatic Drive Control Handle. Refer to specific operating instructions for your machine.

Hydrostatic Drive Control Handle - Version 1

- **To engage the Parking Brake and lower the Ladder**, move the Hydrostatic Drive Control Handle fully to the RIGHT.

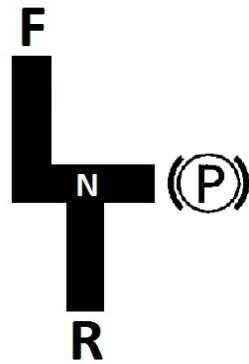

Hydrostatic Drive Control Handle
(Version 1)
-Typical View

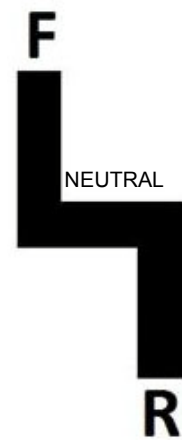

Hydrostatic Drive Control Handle
(Version 2)
-Typical View

**Hydrostatic Drive Control Handle -
Version 2**

⚠ CAUTION

Ensure the Hydrostatic Drive Control Handle is in the NEUTRAL position before engaging the parking brake. Failure to comply may result in personal injury and/or machine damage.

- **To engage the Parking Brake and lower the Ladder**, move the Hydrostatic Drive Control Handle to the NEUTRAL position.

- Slide the red safety lever (located on the Parking Brake Switch) DOWN (Back) and press top of switch DOWN.

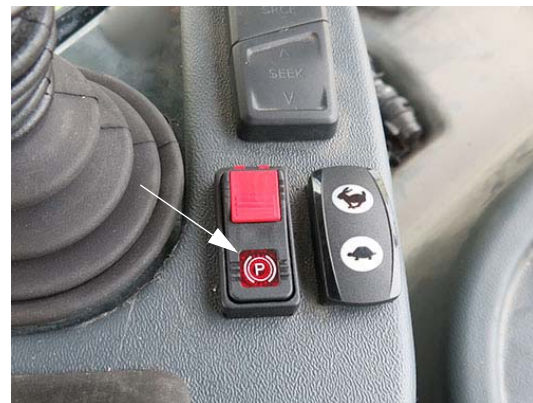

Parking Brake Switch
(Located near the Hydrostatic Drive Control Handle)
-Typical View

** If equipped with Hydrostatic Drive Control Handle - Version 2*

NOTE: When the Parking Brake is ENGAGED, a Parking Brake Indicator (located on the top left-hand side of each Machine Display page) will illuminate.

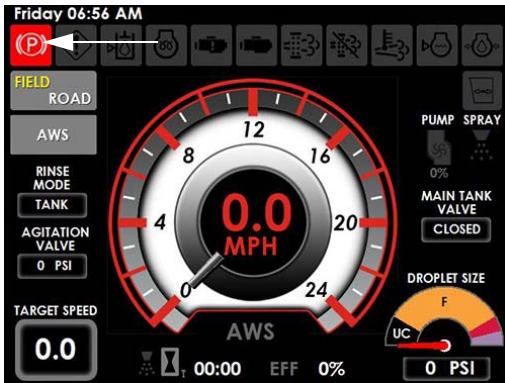

Parking Brake Indicator
(Located on the top left-hand side of each Machine Display page)

To Disengage the Parking Brake

NOTICE

The Decel Pedal must be held in the DOWN position while disengaging the parking brake.

NOTE: If the Hydrostatic Drive Control Handle is out of neutral while the parking brake is engaged, the following warning message will appear on the Machine Display. Press OK to acknowledge.



Parking Brake Warning Message

Hydrostatic Drive Control Handle - Version 1

- To disengage the Parking Brake and raise the Ladder, press and hold the Decel Pedal (located to the lower right-hand side of the steering column) and move the Hydrostatic Drive Control Handle to the LEFT (Neutral position).

Hydrostatic Drive Control Handle - Version 2

- To disengage the Parking Brake and raise the Ladder, press and hold the Decel Pedal (located to the lower right-hand side of the steering column) and press the Parking Brake Switch in the DOWN (Off) position.

Deceleration (Decel) Pedal

When nearing an end row and speed deceleration is desired, press the Decel Pedal (located on the lower right-hand side of the steering column) to decrease speed.

NOTE: The Decel Pedal is NOT a brake! It is designated for speed reduction only.



Decel Pedal
(Located on the lower right-hand side of the steering column)
-Typical View

Setting Decel Pedal Minimum Speed

Refer to “Machine Display” provided in the Cab Section elsewhere in this manual for further information.

Target Speed

The Target Speed (displayed on the Machine Display Home Page - Road and Field Mode) is the speed in which the

machine travels when the Hydrostatic Drive Control Handle is in the fully FORWARD position and the Decel Pedal is NOT pressed.

NOTE: The Target Speed displayed is the maximum speed for the selected speed range.

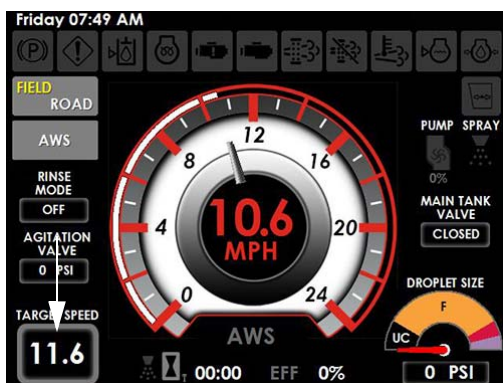

Target Speed
(Located on the Home Page - Road and Field Mode)

To Change Target Speed

Refer to “Machine Display” provided in the *Cab Section* elsewhere in this manual for further information.

Throttle Switch

The Throttle Switch (located near the Hydrostatic Drive Control Handle) is used to control engine speed (RPM).

NOTE: The operator may select throttle setting by operating the Throttle Switch. However, engine speed is also controlled by movement of the Hydrostatic Drive Control Handle.



Throttle Switch
(Located near the Hydrostatic Drive Control Handle)
-Typical View

NOTE: Engine speed can range between 850 and 2300 RPM in both Road and Field Mode.

The Throttle Switch works with a timer to tell the engine how fast to run. The longer the operator holds the switch in either direction (press UP/“rabbit icon” to increase the speed, press DOWN/“turtle icon” to decrease the speed), the more the engine will speed up or slow down.

To Change Throttle Setting Values

Refer to “Machine Display” provided in the *Cab Section* elsewhere in this manual for information.

Speed Ranges

Speed ranges are selected by pressing the Shift Up/Down Switches (located on the Hydrostatic Drive Control Handle). Refer to “Machine Display” provided in the *Cab Section* elsewhere in this manual for further information on adjusting speed range settings.

Example:

If speed ranges are set at 5, 10, 15, and 20 mph (8, 16, 24, and 32 km/h), the machine will start in the 5 mph (8 km/h) target range.

Press the Shift Up Switch once to reach 10 mph (16 km/h). Continue to press switch to reach 15 and 20 mph (24 and 32 km/h), as desired. Press the Shift Down Switch gradually to decrease speed range.

NOTE: The Shift Up/Down Switches can also be held to increase or decrease speed ranges.



Shift Up/Down Switches
(Located on the back side of the Hydrostatic Drive Control Handle - Version 1)
-Typical View



Shift Up/Down Switches
(Located on the side of the Hydrostatic Drive Control Handle - Version 2)
-Typical View

Drive System Control

NOTE: The NEUTRAL position must be met before changing the direction of the machine.

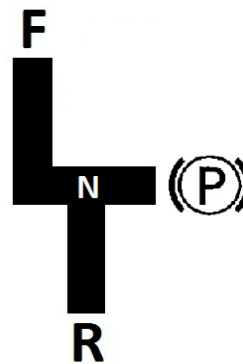

Hydrostatic Drive Control Handle
(Version 1)

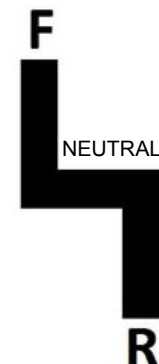

Hydrostatic Drive Control Handle
(Version 2)

- **To move the machine forward**, slowly push the Hydrostatic Drive Control Handle FORWARD.

NOTE: The further the handle is moved forward, the faster the machine will travel and the engine speed will increase.

- **To move the machine in reverse**, slowly pull the Hydrostatic Drive Control Handle backward.

NOTE: Machine speed is limited to 9 mph (14.5 km/h) when in reverse.

NOTE: The farther back the handle is pulled, the faster the machine's speed.

- **To stop the machine**, slowly place the Hydrostatic Drive Control Handle in the NEUTRAL position.

NOTE: Before turning the engine off, reduce the engine speed and allow to idle for a minimum of three (3) minutes.



Hagie Manufacturing Company recommends becoming familiar with and understanding how to operate your machine in conventional steering mode before operating AWS. Understand AWS system components, operating procedures, and system limitations before operating.

The term “coordinated steering” is used to describe the AWS feature. Coordinated steering is when the front wheels turn one direction and the rear wheels turn in the opposite direction to create a tighter turn angle, which allow the rear wheels to follow the front wheel tracks. Operating your machine in AWS mode makes turning more efficient by minimizing crop damage and ground disturbance.

Ensure you are comfortable driving the machine on the road and in the field, with the booms in the transport and spray positions, as well as performing a variety of different turning scenarios before attempting to operate AWS.

Progressive AWS

Hagie Manufacturing Company's Progressive AWS takes the original design and increases the active speed range while maintaining a safe turning radius. This is done by limiting how far the rear wheels will turn at higher speeds. The improvement allows operators to follow contours in the field and leave only one set of wheel tracks. This also allows them to make wide turns on end rows with only one set of wheel tracks.

NOTICE

The operator can choose a minimum level above 850 RPMs of engine speed that they want to operate the machine with by using the Throttle Switch.

ALL-WHEEL STEER (AWS) -If Equipped

^ Operator's with machines equipped with AWS pay special attention!

NOTICE

Become familiar with the machine in both coordinated and conventional steering modes before attempting to use the machine for its intended use. ^

NOTE: Read the following AWS information thoroughly and understand the operating instructions and safety precautions before operating.

Your rear wheels will track the front wheels, with limitations on speed and turning percentage. This is completely variable, so if you accelerate in a turn, your match on the rear will slowly come out. This feature keeps the machine safe when turning.

NOTE: If you want to match all the time, decrease your speed or make a less drastic turn.

Terminology

Conventional Steering

- Only the front wheels turn.

Coordinated Steering ^

- All the wheels turn and do so where the rear tires follow in the front tires' tracks.

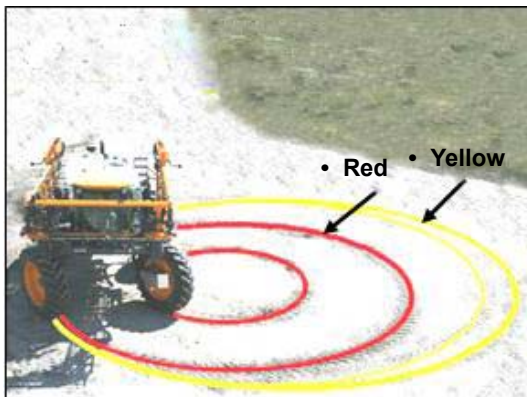

Coordinated Steering (AWS) = Red
Conventional Steering = Yellow

AWS Components

The Steering Cylinder (internal position) and External Proximity Sensors are used to track cylinder rod extension.

Steering Cylinders



Steering Cylinder
(Located on the rear legs)
-Typical View

External Proximity Sensors



External Proximity Sensor
-Typical View

Lock Valves

Each rear cylinder is equipped with two (2) Lock Valves, which lock the cylinders into position when in Road mode and when the machine is not moving in Field mode.

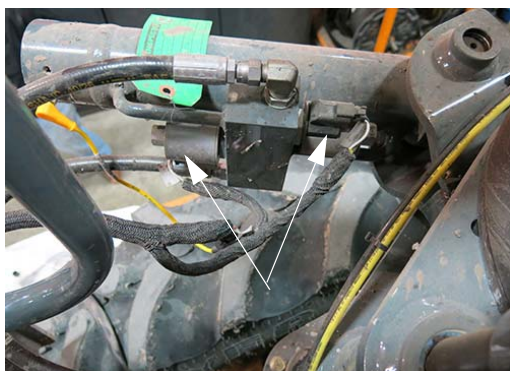

Lock Valves
-Typical View

Valve Manifold

Rear hydraulic steering is controlled by a Valve Manifold (located on the underside of the machine).



Valve Manifold
(Located on the underside of machine)
-Typical View

Operating AWS

All conditions must be met before AWS will activate. First, the machine must be in Field mode, and second, machine speed must be less than AWS Shutoff Speed. If these conditions are not met, the AWS Button will remain ON, but the AWS indicator will turn OFF, and the machine will be operating in conventional steering mode. When conditions are met again, AWS will automatically activate and the AWS indicator will illuminate.

NOTE: The machine will automatically determine if the proper conditions have been met and change the status of the drive functions.

1. Ensure the machine’s drive state is in Field mode.
2. Press the AWS Button (located on the Machine Display Home Page - Field Mode) to the ON (illuminated) position.

• AWS Button

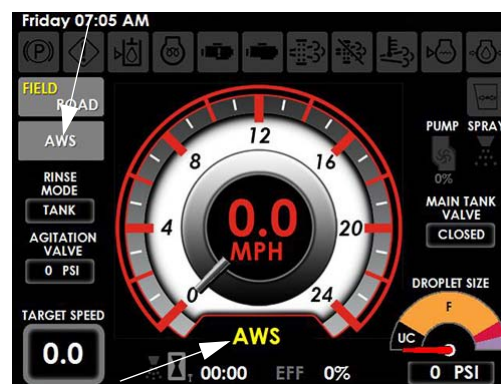

• AWS Indicator

An AWS indicator (located below the speedometer) will illuminate when AWS is activated (requiring all conditions to be met).

Shut off Speed for AWS

Refer to “Machine Display” provided in the *Cab Section* elsewhere in this manual for further information.

Limitations

- Machine speed is greater than AWS Shut-off Speed.

NOTE: There is no warning message associated with this. The machine will automatically switch to conventional steering mode.

- The machine’s drive state must be in Field mode. If the machine is in Road mode, AWS is disabled (and the rear cylinder Lock Valves are locked).
- System Fault - The system is not working properly (e.g. sensor malfunction, hydraulic malfunction, etc.)

NOTE: A warning message will appear on the Machine Display and the machine may be limited on speed and other functions.

- **Auto Steer Machines Only:**
When the Auto Steer System is engaged, it will automatically turn the AWS System OFF and move the rear wheels back to straight.

Recommendations for Best Operating Practices

- Apply the Decel Pedal (located to the lower right-hand side of the steering column) to decrease speed at end rows.

NOTE: The Decel Pedal is NOT a brake! It is designated for speed reduction only.

- Speed ranges are selected by pressing the Shift Up/Down Switches (located on the Hydrostatic Drive Control Handle) to control speed ranges within the vehicle speed settings.
- Use the Hydrostatic Drive Control Handle to slow down more if needed. If you move the Hydrostatic Drive Control Handle first and then shift down to get to AWS mode, you will notice that the machine may slow down more than you wanted it to.
- Understand how the machine feels when it is still in a turn and is shifted up or down. The machine will still operate at whatever turn angle that you want to shift out at, but you may feel that this situation is causing an operation that you may not want (possibly getting the machine off the line intended because the rear wheels move back to straight position and the total turning radius will change).

In the following illustration, the two circles represent a full turn with AWS on. The - - - lines represent the direction the operator wants the front tracks to go

(assuming the operator wants to pull the machine back into rows that are running straight up and down.) The - - - lines represent the direction that the front wheels are pointed when the operator shifts out of AWS speed range. If this occurs, the rear wheels will shift back to the straight position and the machine will no longer have the two tire tracks (two circles). The rear wheels will begin to follow the - - - path during this shift.

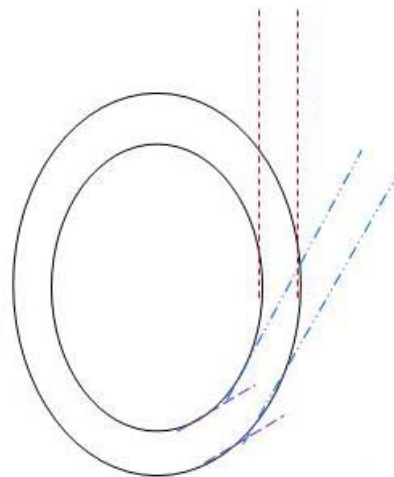

Hagie Manufacturing Company once again strongly recommends trying out and getting a feel for the AWS System before going straight to the field so you can get an understanding of what to expect. Some situations to try include:

- Driving the machine with both an empty and a full solution tank with AWS on.
- Drive the machine on hills, ensuring to take the proper precautions as stated in the *Safety and Precautions Section* elsewhere in this manual.
- Drive the machine at different turn angles and speeds to see how the limitations work.

NOTE: You will notice that if you go over any of the limitations, you can slow back down and the AWS system will automatically turn itself back on.

- **Auto Steer Machines Only:**
Notice how the machine feels when in

- AWS mode and switching from Auto Steer ON to OFF, especially when turning.
- Contact Hagie Customer Support with any questions you may have regarding the operation of the AWS System.

SECTION 5 – HYDRAULIC SYSTEMS

HYDRAULIC SYSTEM COMPONENTS



Hydraulic Pumps (Mounted to the engine)

- Gear Pump
- Pressure Compensated (PC) Pump
- Load Sense (LS) Pump
- Drive Pump

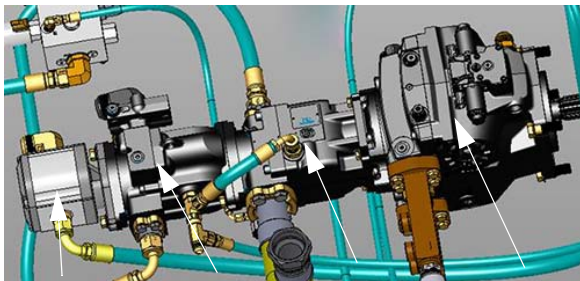

- Gear Pump
- PC Pump
- LS Pump
- Drive Pump

Hydraulic Pumps
(View shown from top of machine)

The four Hydraulic Pumps (mounted to the engine) circulate hydraulic oil throughout the necessary systems and back through the oil cooler before returning it to the reservoir.

NOTE: If the hydraulic oil level in the reservoir drops too low for safe operation, shut down the engine immediately to prevent damage to the hydraulic systems.

Gear Pump

The Gear Pump powers the Reversible Fan motor and control valve.

PC Pump

The PC Pump powers the high-pressure filter, power steering, attachments, tread adjustment valve, side-fill valve, AWS valve (if equipped), and the pressure washer valve (if equipped).

LS Pump

The LS Pump powers the solution pump control valve and detasseler combo option.

Drive Pump

The Drive Pump powers the wheel motors.

Hydraulic Filtering/Cooling Components

- Oil Cooler
- Reservoir
- Return Filter
- Pressure Filter
- Case Drain Filter
- Breather Cap
- Level/Temp Sensor

NOTE: Refer to the Maintenance and Storage Section elsewhere in this manual for information on filling the hydraulic oil reservoir and replacing hydraulic filters.



Oil Cooler
(Located near rear of machine -
open hood to access)
-Typical View



Pressure Filter
(Located beneath right-hand side of
machine - lower metal shield to access)
-Typical View



Hydraulic Oil Reservoir
(Located on left-hand side of
machine - open hood to access)
-Typical View



Case Drain Filter
(Located on left-hand side of machine)
-Typical View



Return Filter
(Located inside filter housing
on left-hand side of machine)
-Typical View



Breather Cap
(Located on left-hand side of
machine near return filter housing)
-Typical View

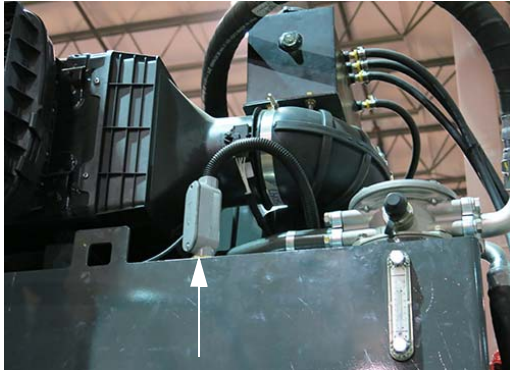

Level/Temp Sensor
(Located on top of hydraulic oil reservoir)
-Typical View

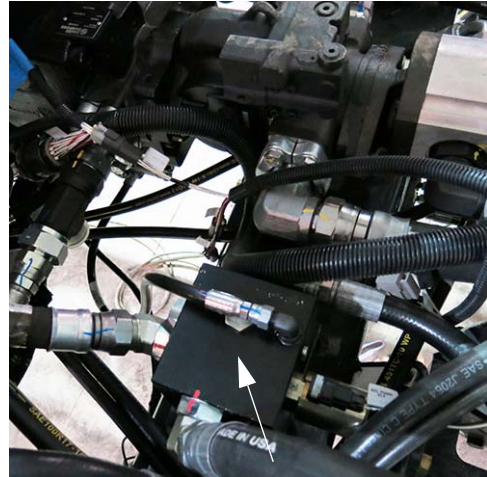

Solution Pump Control Manifold
(Located near center of machine)
-Typical View

* View shown from top of machine

Hydraulic Spray System Components

- Solution Pump
- Solution Pump Control Manifold
- Boom Control Manifold
- NORAC® Boom Leveling System (if equipped)

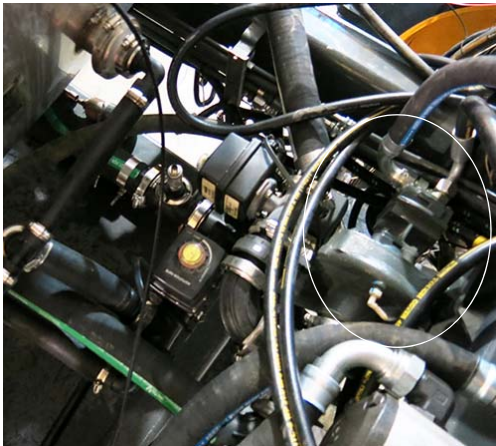

Solution Pump
(Located near center of machine)
-Typical View

* View shown from top of machine

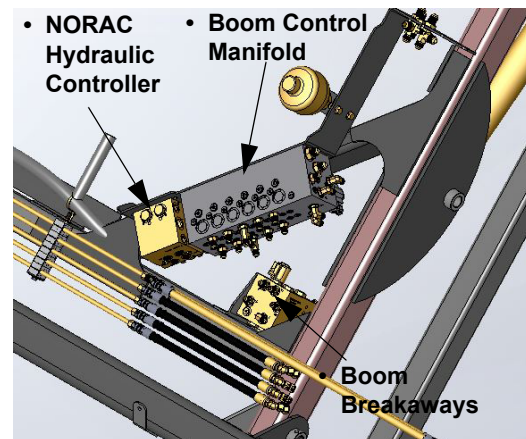

Boom Control Manifold and
NORAC Hydraulic Controller - *if equipped*
(Located on the boom lift arm assembly)
-Typical View

* 90-ft. Spray Boom Shown

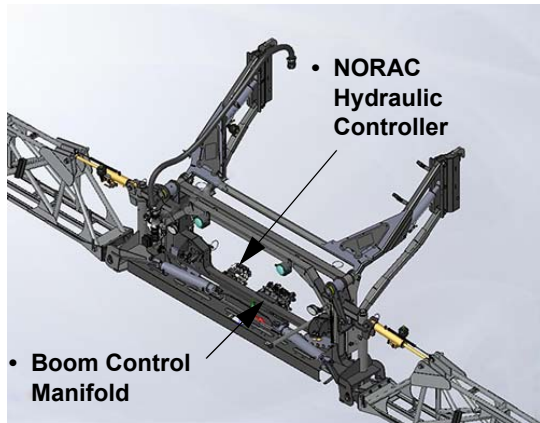

Boom Control Manifold and
NORAC Hydraulic Controller
(Located near center of inner transom)
-Typical View
* 120/132-ft. Spray Booms

Refer to the *Spray Systems Section* elsewhere in this manual for further information.

Hydraulic Detasseling System Components

- (A) - Quad Puller
- (B) - Cutter Head
- (C) - Lift Cylinders
- (D) - Electro-Hydraulic Lift Control Valve
- (E) - Outrigger Fold Valve
- (F) - Motor Control Valve

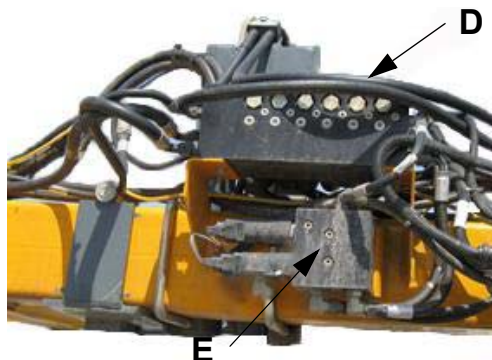
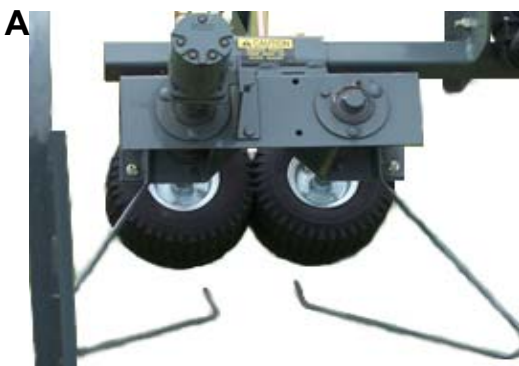

Refer to the *Detasseling Systems Section* elsewhere in this manual for further information.

REVERSIBLE FAN

WARNING

Improper operation, maintenance, or repair of this product can be dangerous and may result in serious injury or death.

- Always use Hagie-approved parts and components. Failure to comply will result in voiding the 1-year parts warranty.
- Do not operate or perform any service on this product until you have read and understand the operation and maintenance information. Contact Hagie Manufacturing Company for any additional information that you may require.
- The person(s) servicing the product may be unfamiliar with many of the systems or components of the product. Use caution when performing service. Knowledge of the product and components are important before the removal or disassembly of any component.

The Reversible Fan is a hydraulically-driven constant pitch fan. Fan speed is controlled based on cooling demand. A signal is sent to the Hydraulic Valve Block (mounted on the side of the fan assembly), which controls the speed and direction of the fan.



Reversible Fan
(Located near the rear of machine
- open hood to access)
-Typical View

To Activate the Reversible Fan

Refer to “Machine Display” provided in the *Cab Section* elsewhere in this manual for complete operating instructions.

Before Starting the Engine

1. Ensure all hoses and wires are adequately secured and routed away from the fan operating area.
2. Ensure all tools have been removed from the engine compartment, including the top side of the radiator and inside of the shroud before the fan guards are installed. Obstacles in the path of rotation can interfere with movement of the fan and can result in damage to the fan blades, fan hub, and radiator core.
3. Inspect the radiator shroud mounting bolts to ensure that the radiator and shroud are firmly secured and unable to move during operation of the machine. Loose shroud bolts can allow the fan shroud to move into the path of the rotating blades and loose radiator mounting bolts can allow the radiator to flex in position, allowing the shroud to come into contact with the rotating fan blades.
4. Ensure all fan guards have been installed and firmly secured into place. The

Reversible Fan creates an abundant amount of airflow in both cooling and cleaning mode operation. The result of this airflow is a strong vacuum effect that can suck in items that are located inside or around the engine compartment fan.

- To ensure maximum efficiency, start with a clean cooling system free of debris, paying particular attention to the stacked cooler core(s).

Service and Maintenance

WARNING

Ensure the Battery Disconnect Switch is OFF before performing any service on the fan. Failure to comply may result in engine turnover, serious injury, or death.

Under normal operating conditions, the Reversible Fan does not require scheduled maintenance (other than lubrication) and is built to provide thousands of hours of trouble-free service.

In moderate to extreme operating conditions, a visual inspection of moving parts is recommended from time to time to safeguard against fan blade damage, which could lead to equipment and/or other damage.

TREAD ADJUSTMENT

-If Equipped

Tread Width can be individually adjusted by pressing and holding the corresponding Tread Width Adjustment Button (located on the Machine Display Auxiliary Controls Page) to desired position.

NOTE: Rear Left and Right Tread Width Indicators are displayed to the left of the Tread Width Adjustment Buttons.

To Adjust Tread Widths

CAUTION

Never adjust the hydraulic tread width on a public roadway. Ensure the machine is on level ground where there are no ditches or valleys to interfere while you perform the adjustment.

- Survey your surroundings and allow yourself enough room to adjust the tread in either forward or reverse.
- While driving one or two miles per hour (1.6 to 3.2 km/h), press and hold the desired Tread Width Adjustment Button (located on the Machine Display Auxiliary Controls Page) to move tread in or out as desired.

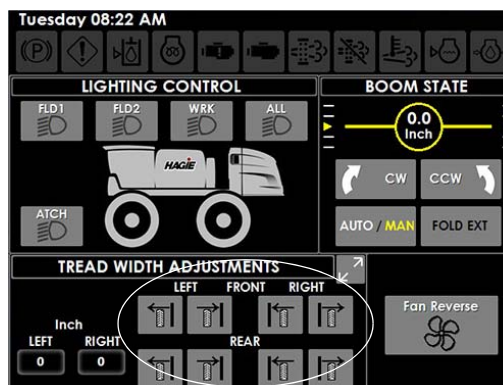

Tread Width Adjustment Buttons
(Located on the Machine Display Auxiliary Controls Page)

To Adjust Multiple Tread Widths

- Press the Tread Page Button (located on the Machine Display Auxiliary Controls Page).

NOTE: This button is marked with two arrows and will navigate to the Tread Adjustment Page.

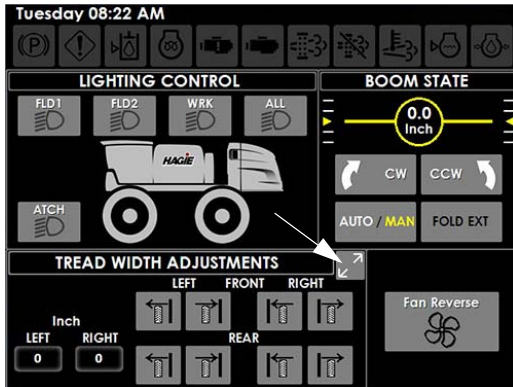

Tread Page Button
(Located on the Machine Display
Auxiliary Controls Page)

- On the Tread Adjustment Page, select the tread that you wish to simultaneously adjust by pressing the desired “wheel(s)” on the display screen.
- While driving one or two miles per hour (1.6 to 3.2 km/h), press and hold the IN or OUT Button until desired tread width is obtained.

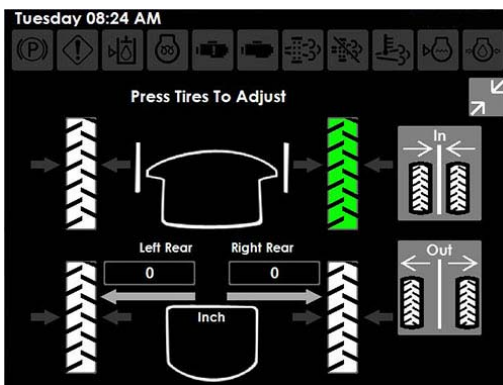

Tread Adjustment Page

NOTE: Press the Tread Page Button again to resume to the previous page.

3. Observe tread width on each leg. The front legs use indicator decals, while the rear legs use electronic sensors and display the readings on the Machine Display Auxiliary Controls Page (to the left of the Tread Width Adjustment Buttons).



Tread Adjust Indicator Decal
(Front Legs)
-Typical View



Tread Adjust Electronic Sensor
(Rear Legs)
-Typical View

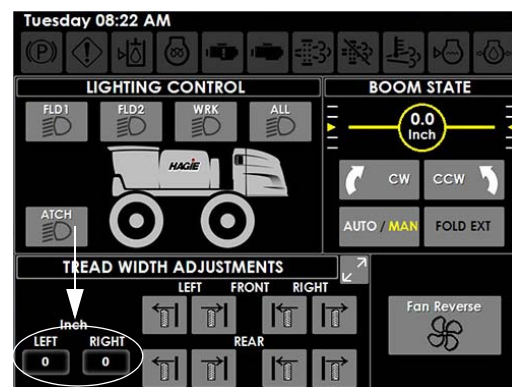

Left/Right Tread Width
Indicators - Rear Legs
(Located on the Machine Display
Auxiliary Controls Page)

4. Release the Tread Adjustment Button when desired tread width is achieved.

All four tread width indicators should have identical readings after tread adjustment is complete.

NOTE: When significant adjustment is being made, it is recommended that you adjust one leg at a time and perform the adjustments in smaller increments. Binding may occur if a larger adjustment is made all at once, especially if adjusting one leg at a time.

LADDER

CAUTION

Upright ladder is not a service platform or step.

- DO NOT step on the ladder while in the upright position.
- DO NOT lower the ladder while anyone is on the ground near the machine.
- DO NOT attempt to lower the ladder from ground level.

To Lower the Ladder

NOTE: Your machine is equipped with either Version 1 or Version 2 of the Hydrostatic Drive Control Handle. In addition to difference in the placement of controls, Version 1 allows the Parking Brake to engage/disengage and the Ladder to extend/retract through the Hydrostatic Drive Control Handle (moving the handle fully to the right). For machines equipped with Version 2, a separate parking brake switch is located adjacent to the Hydrostatic Drive Control Handle (which engages the Parking Brake and lowers the Ladder when activated). Refer to specific operating instructions for your machine.

Hydrostatic Drive Control Handle - Version 1

- **To lower the Ladder**, move the Hydrostatic Drive Control Handle fully to the RIGHT.

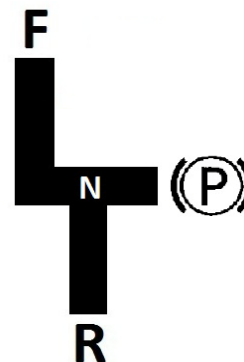

Hydrostatic Drive Control Handle
(Version 1)
-Typical View

Hydrostatic Drive Control Handle - Version 2

CAUTION

Ensure the Hydrostatic Drive Control Handle is in the NEUTRAL position before engaging the parking brake. Failure to comply may result in personal injury and/or machine damage.

- **To lower the Ladder**, move the Hydrostatic Drive Control Handle to the NEUTRAL position.

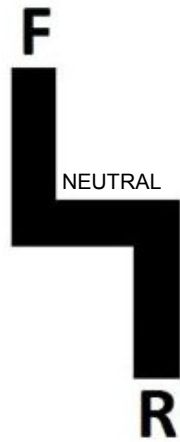

Hydrostatic Drive Control Handle
(Version 2)
-Typical View



Ladder
-Typical View
** Lowered position shown*

- Slide the red safety lever (located on the Parking Brake Switch) DOWN (Back) and press top of switch DOWN.



Parking Brake Switch
(Located near the Hydrostatic
Drive Control Handle)
-Typical View

** If equipped with Hydrostatic Drive
Control Handle - Version 2*

NOTE: When the Ladder is lowered and the Parking Brake is engaged, a Parking Brake Indicator (located on the top left-hand side of each Machine Display page) will illuminate.

To Raise the Ladder

Hydrostatic Drive Control Handle - Version 1

- **To raise the Ladder**, press and hold the Decel Pedal (located to the lower right-hand side of the steering column) and move the Hydrostatic Drive Control Handle to the LEFT (Neutral position).

Hydrostatic Drive Control Handle - Version 2

- **To raise the Ladder**, press and hold the Decel Pedal (located to the lower right-hand side of the steering column) and press the Parking Brake Switch in the DOWN (Off) position.

*NOTE: When the Ladder is raised, the
Parking Brake will be OFF
(disengaged).*

SECTION 6 – ELECTRICAL SYSTEMS

WARNING

**CALIFORNIA PROPOSITION
65 WARNING**

WARNING: Diesel engine exhaust and some of its constituents are known to the State of California to cause cancer and birth defects or other reproductive harm.

WARNING: Battery posts, terminals, and related accessories contain lead and lead compounds, and chemicals known to the State of California to cause cancer and birth defects or other reproductive harm.

Access

The batteries are located on the left-hand side of machine. Open hood to access.

NOTE: When servicing the electrical system, always remove the batteries (removing the ground cable first). When reinstalling the batteries, connect the ground cable last.



Battery Access

(Located on the left-hand side of machine - open hood to access)
-Typical View

BATTERIES

CAUTION

Batteries contain sulfuric acid. Avoid contact with skin, eyes, or clothing. Do not inhale fumes or ingest liquid. Batteries contain gases which can explode. Keep sparks and flame away while servicing.

CAUTION

Disconnect the battery when servicing any part of the electrical system. Failure to comply may result in injury and property damage.

NOTICE

Use a sturdy stationary ladder to safely access/service the batteries.

Charging

CAUTION

Electrical system is 12-volt negative ground. When using booster with jumper cables, precautions must be taken to prevent personal injury or damage to electrical parts.

1. Attach one end of jumper cable to positive booster terminal and other end to positive terminal of vehicle battery connected to starter motor.
2. Attach one end of second cable to negative booster terminal and other end to vehicle frame away from battery.
3. To remove cables, reverse above sequence exactly to avoid sparks. See operator's manual for additional information.

650296

For your convenience, a set of Auxiliary Battery Charging Posts are located on the rear mainframe for ease of charging the batteries.



Auxiliary Battery Charging Posts
(Located on the rear mainframe)
-Typical View

Connect your charging cables to the Auxiliary Battery Charging Posts just as you would to the battery - positive cable to the positive terminal, and negative cable to the negative terminal.

NOTE: Keep these terminals clean and their caps in place when not in use.

NOTICE

To ensure sufficient electrical contact, battery terminal connections should be as clean and tight as possible.

Cleaning

- Disconnect the battery cables from the batteries.
- Remove any corrosion with a wire brush or battery post brush.
- Wash the battery cable connections and posts with a mild baking soda and ammonia solution.
- Apply grease (or dielectric grease) to prevent corrosion.
- Reconnect the batteries, ensuring connections are tight.
- Clean every 100 hours of operation.

Replacement

Install replacement batteries with ratings equivalent to the following specifications:

- **Voltage** - 12V only
- **CCA** - 30 seconds at 0° F. (950)
- **Reserve Capacity** - 185 minutes at 25 amps

Storage

Refer to “Storage” provided in the *Maintenance and Storage Section* elsewhere in this manual for further information.

BATTERY DISCONNECT SWITCH



Your machine is equipped with a Battery Disconnect Switch (located on the rear mainframe).

- Rotate the Battery Disconnect Switch to the ON (clockwise) or OFF (counter-clockwise) positions to operate.



Battery Disconnect Switch
(Located on the rear mainframe)
-Typical View

NOTE: DO NOT use the Battery Disconnect Switch as a safety device when performing work to the electrical system. Disconnect the negative battery cable before servicing.

FUSES AND RELAYS

Interior Cab Functions



Circuit Breakers/Fuses (Interior)
(Located rear of side console -
remove tray to access)
-Typical View

The following label is affixed beneath the side console (remove tray to access) and provides information on component fuse/relay amperage ratings.

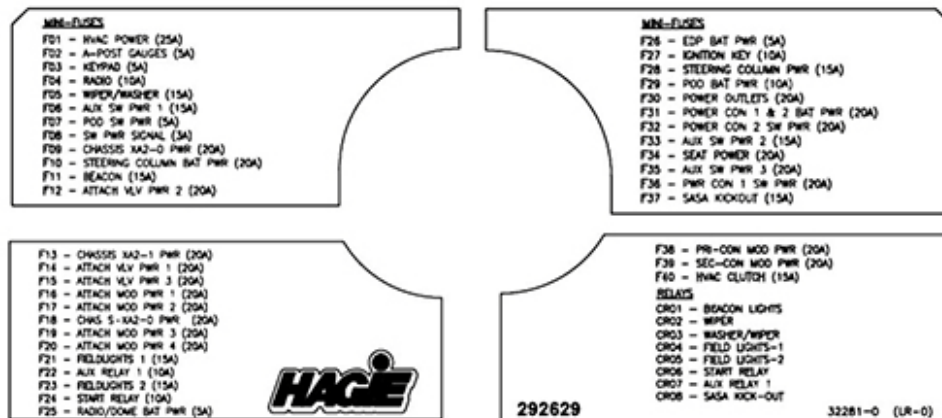

Exterior Lights/System Functions



Circuit Breakers/Fuses (Exterior)
(Located beneath cab -
remove panel to access)
-Typical View

The following label is affixed beneath the cab and provides information on component fuse/relay amperage ratings.

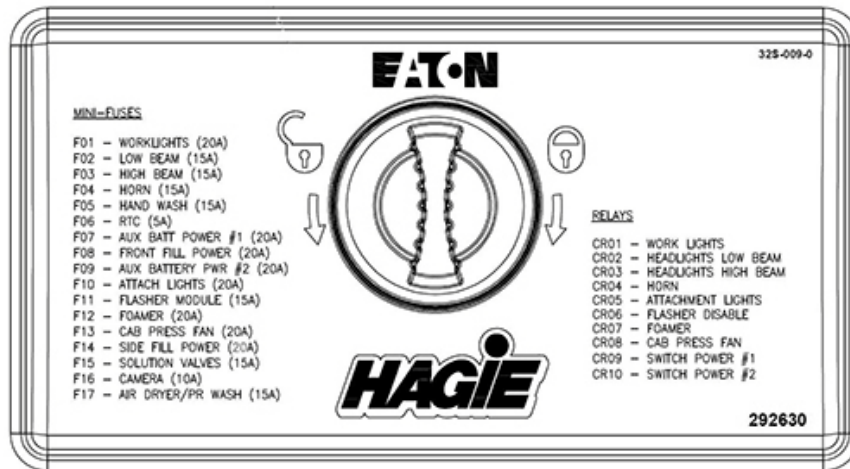

Tier 4 Final Engine

-If Equipped



Tier 4 Final Engine Fuse/Relay Block
(Located beneath batteries on
the rear left-hand side of machine)

-Typical View

* View shown from beneath machine

The following labels are affixed near the engine fuse/relay block and provide information on component fuse/relay amperage ratings.

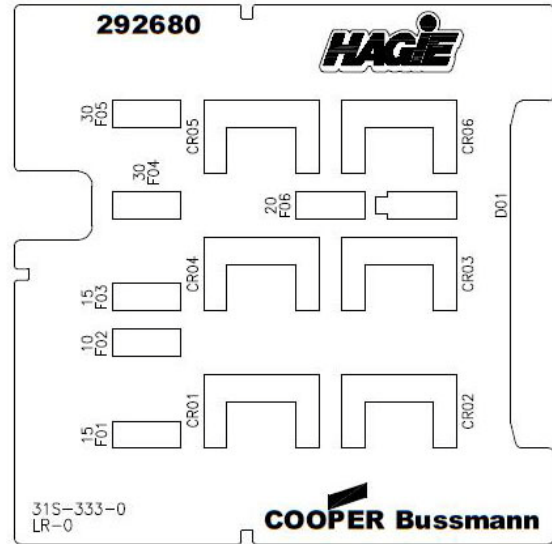
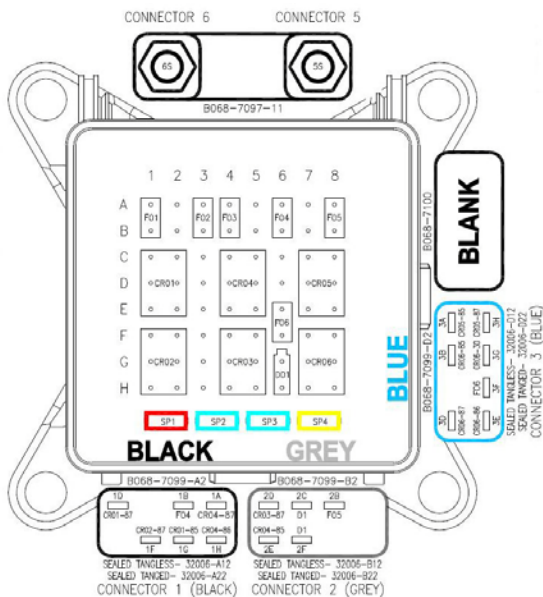

Device Placement

Pos.	Ref.	Device	Part No.
D1	F01	Mini Fuse	ATM-15UNP-PEC
D2	F02	Mini Fuse	ATM-10UNP-PEC
D3	F03	Mini Fuse	ATM-15UNP-PEC
D4	F04	Mini Fuse	ATM-30UNP-PEC
D5	F05	Mini Fuse	ATM-30UNP-PEC
D6	R1	12V, 35A 5-Pin Micro	B120-7025
D7	R4	12V, 35A 5-Pin Micro	B120-7025
D8	R5	12V, 35A 5-Pin Micro	B120-7025
D9	F06	Mini Fuse	ATM-20UNP-PEC
D10	R2	12V, 35A 5-Pin Micro	B120-7025
D11	R3	12V, 35A 5-Pin Micro	B120-7025
D12	R6	12V, 35A 5-Pin Micro	B120-7025
D13	D01	6A Diode	22903-6V

Spare Device Placement		
Position	Device	Part No.
SP1	Mini Fuse	ATM-10UNP-PEC
SP2	Mini Fuse	ATM-15UNP-PEC
SP3	Mini Fuse	ATM-20UNP-PEC
SP4	Mini Fuse	ATM-30UNP-PEC

Device Totals		
Device	Part No.	Amount
Mini Fuse	ATM-10UNP-PEC	2
Mini Fuse	ATM-15UNP-PEC	3
Mini Fuse	ATM-20UNP-PEC	2
Mini Fuse	ATM-30UNP-PEC	3
6A Diode	22903-6V	1
12V, 35A 5-Pin Micro	B120-7025	6

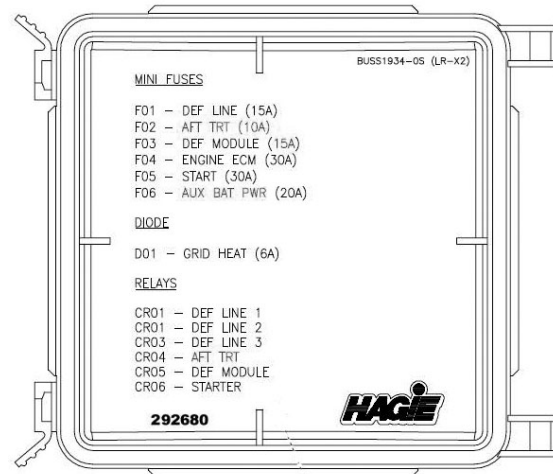

Hood Actuator Fuse



Hood Actuator Fuse
(Located near rear
left-hand side of machine)
-Typical View

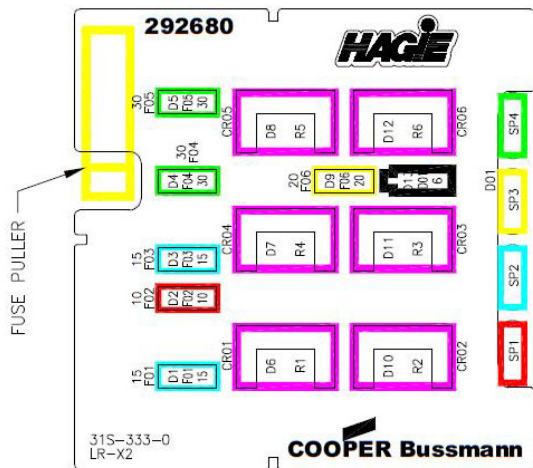

FUSE AND RELAY RATINGS

Fuses and Relays - Exterior (Located Beneath Cab) <i>* Remove panel to access</i>		
Fuse	Rating (Amps)	Function
F01	20	Work Lights
F02	15	Highway Lights (Low Beam)
F03	15	Highway Lights (High Beam)
F04	15	Horn
F05	15	Hand Wash
F06	5	RTC Battery Power
F07	20	Auxiliary Battery Power 1
F08	20	Front-Fill
F09	20	Auxiliary Battery Power 2
F10	20	Attachment Lights
F11	15	Flasher Module
F12	20	Foam Marker
F13	20	Cab Pressure Fan
F14	20	Side-Fill
F15	15	Solution Valves
F16	10	Camera
F17	15	Air Dryer
Relay	Ratings (Amps)	Function
CR01	35	Work Lights
CR02	35	Headlights (Low Beam)
CR03	35	Headlights (High Beam)
CR04	35	Horn
CR05	35	Attachment Lights
CR06	35	Flasher Disable
CR07	35	Foam Marker
CR08	35	Cab Pressure Fan
CR09	35	Switch Power 1

CR10	35	Switch Power 2
Fuses and Relays - Interior (Located Rear of Side Console) <i>* Remove tray to access</i>		
Fuse	Rating (Amps)	Function
F01	25	HVAC Power
F02	5	A-Post Gauges
F03	5	Boom Solution Valves (Spray Section Keypad)
F04	10	Radio Power
F05	15	Wiper/Washer Power
F06	15	Auxiliary Switched Power 1
F07	5	Pod Switched Power
F08	3	Power Mirrors/Power Signal for Auxiliary Switched Power (beneath cab)
F09	20	Chassis XA2-0 Power
F10	20	Steering Column/Battery Power
F11	15	Rotating Beacons
F12	20	Attachment Valve Power 2
F13	20	Chassis XA2-1 Power
F14	20	Attachment Valve Power 1
F15	20	Attachment Valve Power 3
F16	20	Attachment Module 1 Power
F17	20	Attachment Module 2 Power
F18	20	Chassis S-XA2-0 Power
F19	20	Attachment Module 3 Power
F20	20	Attachment Module 4 Power
F21	15	Field Lights 1
F22	10	Auxiliary Relay 1
F23	15	Field Lights 2
F24	10	Start Relay
F25	5	Radio/Dome Light
F26	5	EDP Battery Power
F27	10	Ignition Key
F28	15	Steering Column Power

F29	10	Pod Battery Power
F30	20	Power Outlets
F31	20	Power Connector 1 and 2 Battery Power
F32	20	Power Connector 2/Switched Power
F33	15	Auxiliary Switch Power 2
F34	20	Seat Power
F35	20	Auxiliary Switch Power 3
F36	20	Power Connector 1/Switched Power
F37	15	SASA Kick-out Signal
F38	20	Primary Controller Power (beneath cab)
F39	20	Secondary Controller Power (beneath cab)
F40	15	HVAC Clutch
Relay	Rating (Amps)	Function
CR01	35	Rotating Beacon Lights
CR02	35	Wiper
CR03	35	Wiper/Washer
CR04	35	Field Lights 1
CR05	20	Field Lights 2
CR06	20	Start Relay
CR07	35	Auxiliary Relay 1
CR08	20	SASA Kick-out Relay
Fuses and Relays - Tier 4 Final Engine (Located on Engine Skid Beneath Batteries)		
Fuse (Mini)	Rating (Amps)	Function
F01	15	DEF Line
F02	10	After Treatment
F03	15	DEF Module
F04	30	Engine ECM
F05	30	Start
F06	20	Auxiliary Battery Power
Diode	Rating (Amps)	Function

D01	6	Grid Heater
Relay	Rating (Amps)	Function
CR01		DEF Line 1
CR01		DEF Line 2
CR03		DEF Line 3
CR04		After Treatment
CR05		DEF Module
CR06		Starter

VIDEO CAMERA INPUT CONNECTIONS

Your machine is equipped with a Video Camera (operated through the Machine Display) for your convenience when operating the machine in reverse and is located on the rear of the sprayer.

Two additional Video Camera Input Connections (located beneath cab - remove front panel to access) are provided for the installation of add-on video camera(s).



Video Camera Input Connections
(Located beneath cab -
remove front panel to access)
-Typical View

Refer to “Machine Display” provided in the *Cab Section* elsewhere in this manual for further information.

SECTION 7 – SPRAY SYSTEMS

SPRAY BOOM HOSE CLAMP INSTALLATION

(120/132' Spray Booms)

Four (4) Boom Hose Clamps have been shipped loose with your machine and are located inside the cab. Refer to the following instructions to install clamps before operating the spray booms.

NOTICE

Boom hose clamps must be installed initially before unfolding the spray booms. Failure to comply will result in the solution hoses becoming obstructed with the boom, causing property damage.

To Install Boom Hose Clamps

1. Engage the parking brake.
2. Start the engine.
3. Press and hold the corresponding Left and Right-Hand Boom Switches (located on the Hydrostatic Drive Control Handle) in the UP position to remove boom wings from cradles.



Left and Right-Hand Boom Switches
(Located on the Hydrostatic Drive Control Handle - Version 1)
-Typical View

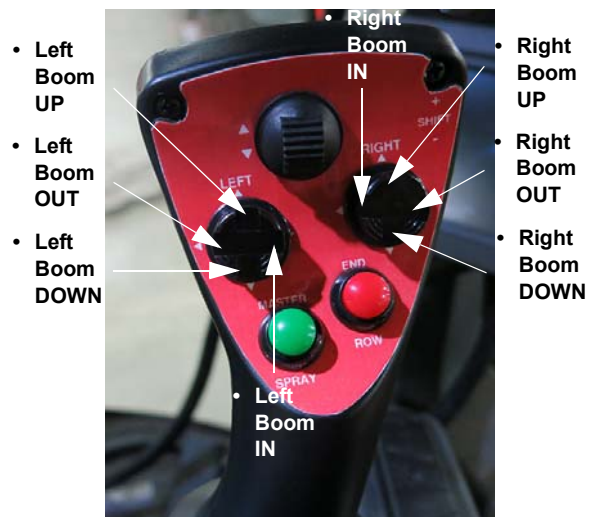

Left and Right-Hand Boom Switches
(Located on the Hydrostatic Drive Control Handle - Version 2)
-Typical View

NOTICE

Unfold booms far enough to clear the boom cradles only. Unfolding the booms to the fully extended position before installing the boom hose clamps will result in property damage.

4. Press and hold the corresponding Left and Right-Hand Boom Switches in the OUT position to unfold the boom wings until **partially** open.
5. Press and hold the Transom Switch (located on the Hydrostatic Drive Control Handle) in the DOWN position and lower boom to the ground.
6. Shut the engine off.
7. Obtain the four (4) Boom Hose Clamps (located inside cab).
8. Loosen nuts on each Boom Hose Clamp and remove bolts. Set aside for later use.
9. Rotate the Hose Routing Bracket (located near the end of the outer boom fold) so the wide end of bracket is facing outward (towards hose), as shown.

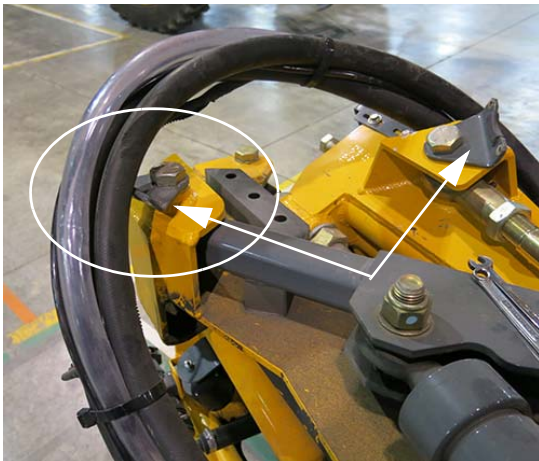

Hose Routing Brackets (2)
(Located near the end of outer boom fold)
-Typical View

10. Install Boom Hose Clamp over top of the hose routing.



Boom Hose Clamp
-Typical View

11. Aligning Boom Hose Clamp hole with the Hose Routing Bracket hole, install bolt (previously removed in Step 8) through the clamp and bracket. Install second bolt to clamp.
12. Hand-start nut on each bolt (as shown in the following photo). Tighten nut with a 7/16" wrench and bolt with a 3/8" wrench.

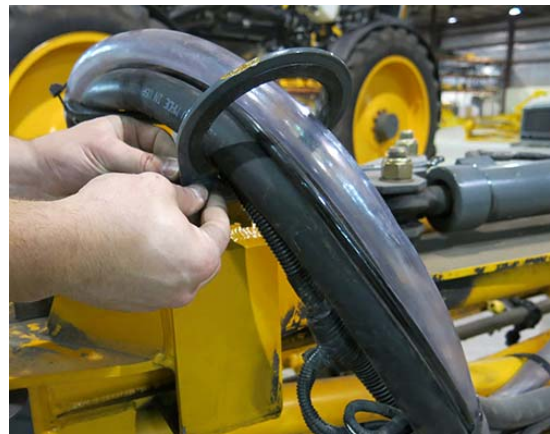

-Typical View

13. Following Steps 9-12, install second Boom Hose Clamp to additional Hose Routing Bracket (as shown in the following photo).



Boom Hose Clamp Installation
-Typical View

14. Repeat Steps 9-13 on opposite boom.

SPRAY BOOMS - 90/100'

-If Equipped

The spray booms are controlled by an electro-hydraulic system. This system consists of operator-manipulated switches (located on the side console and the hydrostatic drive control handle) and hydraulic cylinders (attached to the booms), which provide lift, level, horizontal extension, and vertical extension.

CAUTION

When operating or positioning the booms, observe the following safety precautions. Failure to comply may result in injury or equipment damage.

- Do not unfold/fold boom extensions when main boom is in cradle.
- Do not operate machine with one boom out of cradle and the other boom in cradle.
- Ensure booms are folded and in cradle before transporting the machine.

WARNING

When operating or positioning the booms, observe the following safety precautions:

- Monitor both sides of the boom during fold procedure.
- Cradle booms when leaving the machine unattended.
- Ensure booms are folded when cradled.
- Select a safe area before unfolding/folding the booms.
- Clear area of personnel.
- Check for overhead obstructions.
- Do not unfold/fold booms near power lines. Contact with power lines can result in serious injury or death.
- Spray equipment is designed for FIELD USE ONLY. Do not attempt to use machinery for anything other than its intended purpose.

WARNING

Hydraulic and electrical control systems are optimized for use of the spray boom attachment. Any modification to these systems may lead to unintended and uncontrolled motion. DO NOT install add-on control systems that are not approved by Hagie Manufacturing Company.

Power Lines

Hagie Manufacturing Company cannot stress enough that extreme caution must be taken when operating equipment near power lines. Ensure there is more than sufficient clearance when transporting, unfolding and folding the boom, or spraying near power lines.



As a safety precaution, a Power Line Warning Message will appear on the Machine Display before extending the outer boom extensions. Press ACKNOWLEDGE showing that you have acknowledged that there are no overhead power lines or obstructions before proceeding.

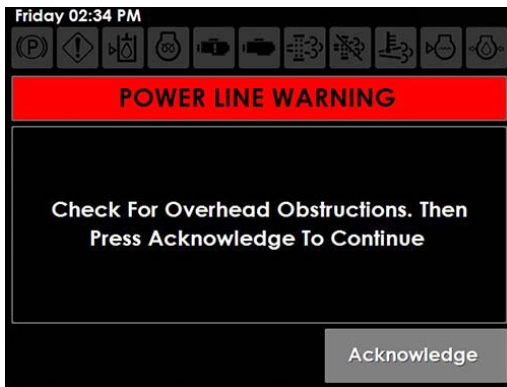

Power Line Warning Message
(Located on the Machine Display)

Hydraulically folding the extensions of a 60/80/90-ft. or 60/100-ft. spray boom, adjusting the spray valves, and shutting off the outer sections essentially turns it into a 60-ft. spray boom.

Manually folding the outer extensions of a 60/80/90-ft. spray boom, adjusting the spray valves, and shutting off the outer sections turns it into an 80-ft. spray boom (see the following illustrations).

Refer to the Spray System Console calibration information provided elsewhere in this section for further information.

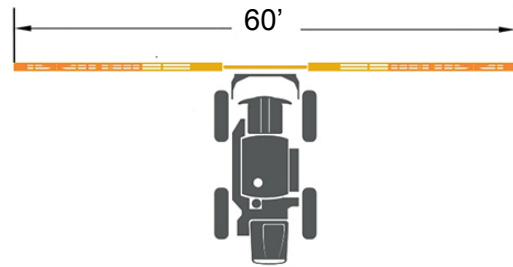

60/80/90' System with
Extensions Folded Over

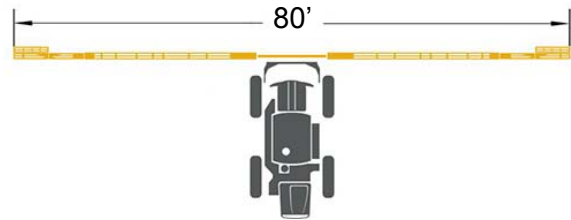

60/80/90' System with Outer
Extensions Manually Folded Forward

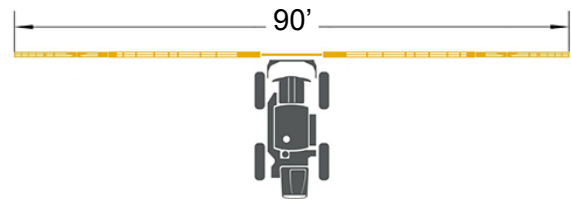

60/80/90' System with all
Extensions Folded Out

Spray Boom Components

- (A) - Lift Cylinder
- (B) - Transom
- (C) - Main Pivot Cylinder
- (D) - Level Cylinder
- (E) - Lift Arm
- (F) - Main Boom Section
- (G) - Boom Extension Cylinder
- (H) - Boom Extension (Outer Boom Section)
- (I) - Boom Breakaway Cylinder



Hydraulic Breakaway Circuit (90 and 100-ft. Spray Booms)

90 and 100-ft. spray booms are equipped with a Hydraulic Breakaway Circuit. When folded out as an 80, 90, or 100-ft. spray boom, a one-way hydraulic circuit (located on the outer boom section) provides outer boom breakaway functions.



Outer Boom Breakaway
-Typical View

When the outer boom section breaks away, it will return to the “spray” position (after it has cleared the hazard), but will not be in the locked position.

To Reset the Outer Boom Breakaway:

- Press and hold the Reset Breakaways Button (Located on the Machine Display Auxiliary Controls Page) until the outer boom sections are in the LOCKED position.

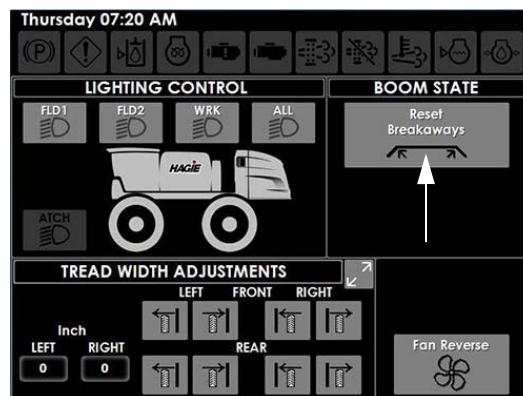

Reset Breakaways Button
(Located on the Machine Display
Auxiliary Controls Page)

NOTE: On 90-ft. spray booms, the main breakaways cannot be folded unless machine speed is less than 5 mph (8 km/h).

Spray Boom Extension (Unfold)

⚠ CAUTION

Booms will unfold vertically even if they are still in the boom cradle or are not horizontally extended.

NOTICE

Do not lower the main lift while the boom is in cradle. Failure to comply will result in property damage.

NOTE: Ensure the Hydrostatic Drive Control Handle is in the NEUTRAL or PARK position. If the machine is put in gear during fold operation, boom movement will stop.

1. Press and hold the corresponding Left and Right-Hand Boom Switches (located on the Hydrostatic Drive Control Handle) in the UP position to raise the level cylinders all the way up.



Left and Right-Hand Boom Switches
(Located on the Hydrostatic Drive Control Handle - Version 1)
-Typical View

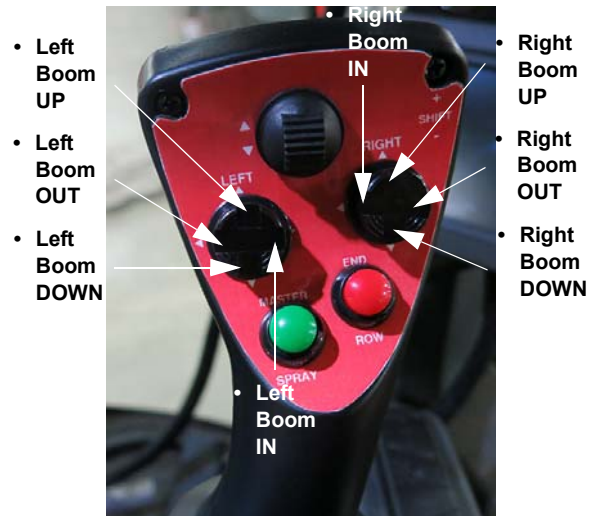

Left and Right-Hand Boom Switches
(Located on the Hydrostatic Drive Control Handle - Version 2)
-Typical View

2. Press and hold the corresponding Left and Right-Hand Boom Switches in the OUT position to unfold the main boom sections until they come to a complete stop.
3. Lower the level cylinders until the boom is parallel with the ground.

90-ft. Spray Booms

- Press and hold the Boom Extension Switch (located on the side console) in the UP position to unfold the left and right boom extensions all the way OUT.

NOTE: Both left and right boom extensions move simultaneously when the Boom Extension Switch is pressed.



Boom Extension Switch
* 90-ft. Spray Booms
(Located on the side console)
-Typical View



Boom Extension Switch
* 90-ft. Spray Booms
(Located on the side console)
-Typical View

Spray Boom Retraction (Fold)

NOTE: Ensure the Hydrostatic Drive Control Handle is in the NEUTRAL or PARK position. If the machine is put in gear during fold operation, boom movement will stop.

1. Lower the level cylinders until the boom is parallel with the ground.

90-ft. Spray Booms

- Press and hold the Boom Extension Switch (located on the side console) in the DOWN position to fold the left and right boom extensions all the way IN.

NOTE: Both left and right boom extensions move simultaneously when the Boom Extension Switch is pressed.

2. Press and hold the corresponding Left and Right-Hand Boom Switches (located on the Hydrostatic Drive Control Handle) in the UP position to raise the level cylinders all the way up.



Left and Right-Hand Boom Switches
(Located on the Hydrostatic Drive Control Handle - Version 1)
-Typical View



Left and Right-Hand Boom Switches
(Located on the Hydrostatic Drive
Control Handle - Version 2)
-Typical View

3. Press and hold the corresponding Left and Right-Hand Boom Switches in the IN position until the main boom sections are aligned with boom cradles.
4. Lower the level cylinders until the boom sections are seated in the boom cradles.

Manual Fold

(90-ft. Spray Boom to an 80-ft. Spray Boom)

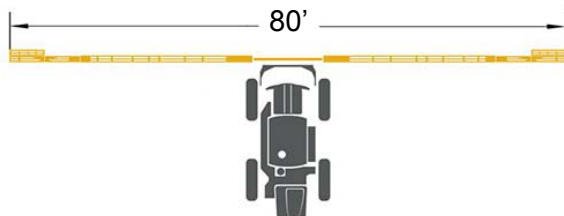

60/80/90' System with Outer
Extensions Manually Folded Forward

1. Press Boom Solution Valve Switches - Sections 1 and 9 (located on the side console) to the OFF position.



Boom Solution Valve
Switches - Sections 1 and 9
(Located on the side console)
-Typical View

2. Remove the Securement Bolt (located on the back side of boom) and hinge outer section forward.



Securement Bolt
(Located on the back side of boom)
-Typical View



3. Secure into place with the rear Securement Bolt.
4. Repeat Steps 2-3 on opposite side of machine.

Enabling/Disabling NORAC® in the Pulse Display

-If Equipped

NOTE: Hagie Manufacturing Company recommends turning the NORAC Monitor OFF when traveling from one field to the next. A power switch is located on the back side of the monitor.



NORAC Monitor
-Typical View

- **To Enable**, press the corresponding Auto or Manual Button (located on the main “Run Screen”) to the ON (green illuminated position).

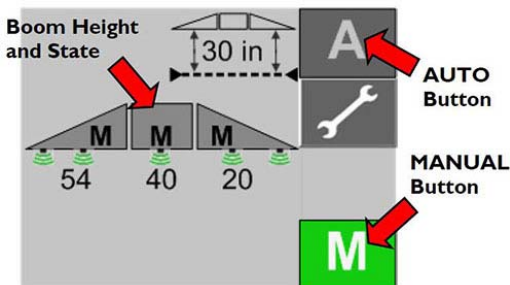

Auto/Manual Buttons - NORAC
(Located on the main “Run Screen”)
-Typical View

** Your monitor may vary in appearance, depending on model*

- **To Disable**, press the corresponding Auto or Manual Button to the OFF (gray) position or press any one of the following boom control switches (located on the Hydrostatic Drive Control Handle):

- Transom Switch (Up/Down)
- Left or Right-Hand Boom Switch (Up/Down)

NOTE: If the NORAC System becomes inoperable, the Auto and Manual Fold functions will still operate.

Enabling/Disabling NORAC in the Ag Leader® Display

-If Equipped

- **To Enable**, press the Auto/Manual Button (located on the main “Run Screen”) to the ON (green illuminated position).

NOTE: When the system is engaged, the boom image will change from black to blue.



Auto/Manual Button - Ag Leader
(Located on the main “Run Screen”)
-Typical View

** Your monitor may vary in appearance, depending on model*

- **To Disable**, press the Auto/Manual Button to the OFF (white) position or press any one of the following boom control switches (located on the Hydrostatic Drive Control Handle):
- Transom Switch (Up/Down)
- Left or Right-Hand Boom Switch (Up/Down)

NOTE: When the system is disabled, the boom image will change from blue to black.

NOTE: If the NORAC System becomes inoperable, the Auto and Manual Fold functions will still operate.

NORAC/Ag Leader System Settings

-If Equipped (Soil/Crop Mode, Target Height, and Sensitivity)

NOTE: Settings may be adjusted through the main Run Screen by pressing the Boom Image or the Settings Button (wrench icon), depending on model. Refer to the NORAC or Ag Leader manufacturer’s operation manual for further information.

Soil/Crop Mode

Soil Mode allows the sensors to read the height from the spray nozzles to the ground. Crop Mode allows the sensors to read the height from the spray nozzles to the top of the crop canopy.

On the NORAC Pulse Monitor:

- Press the Settings Button (wrench icon) (located on the main “Run Screen”) to navigate to the Settings Screen.
- Press the Next Button (located next to “Mode”) and select Soil, Crop, or Hybrid Mode.

NOTE: Hybrid Mode is an improved Crop Mode, which uses a combination of the crop and soil readings to improve control. This setting is recommended in place of Crop Mode.

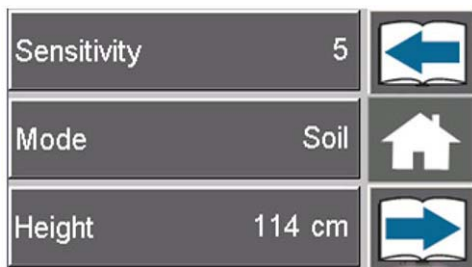

Settings Screen
(NORAC)
-Typical View

** Your monitor may vary in appearance, depending on model*

On the Ag Leader Monitor:

- Press the Boom Image (located on the main “Run Screen”).
- Press the top drop-down arrow (located on the Boom Height Control Options Screen) and select Soil or Crop Mode.

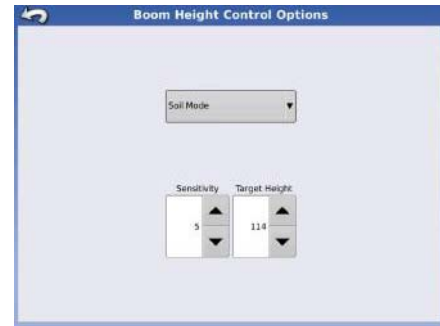

Boom Height Control Options Screen
(Ag Leader)
-Typical View

** Your monitor may vary in appearance, depending on model*

Sensitivity

Sensitivity is how responsive the system is. The lower the number, the lower the sensitivity. The higher the number, the higher the response time and hydraulic demand.

NOTE: Default sensitivity setting is 5.

On the NORAC Pulse Monitor:

- Press the Settings Button (wrench icon) (located on the main “Run Screen”) to navigate to the Settings Screen.
- Press the Next Button (located next to “Sensitivity”) and increase or decrease system sensitivity values from 1-10.

On the Ag Leader Monitor:

- Press the Boom Image (located on the main “Run Screen”).
- Press the Sensitivity Buttons (located on the Boom Height Control Options Screen) and increase or decrease system sensitivity values from 1-10.

Target Height

Target Height is the height you desire the boom to be set at when spraying.

NOTE: When operating in Soil Mode, the Target Height is measured from the spray nozzles to the soil. In Crop Mode, the target height is measured from the crop canopy to the spray nozzles.

On the NORAC Pulse Monitor:

- Press the Settings Button (wrench icon) (located on the main “Run Screen”) to navigate to the Settings Screen.
- Press the Next Button (located next to “Height”) and increase or decrease values to desired boom height.

On the Ag Leader Monitor:

- Press the Boom Image (located on the main “Run Screen”).
- Press the Target Height Buttons (located on the Boom Height Control Options Screen) and increase or decrease values to desired boom height.

Further Information

Refer to the NORAC or Ag Leader manufacturer’s operation manual for complete operating/calibration instructions, troubleshooting information, and safety precautions.

Refer to “Specifications” provided in the *Introduction Section* elsewhere in this manual for information on GPS dimensions on your machine.

Enabling NORAC through the End Row Management Switch

**-If Equipped
(Typical View - appearance may vary, depending on model)**

1. Program the End Row Management Switch (located on the Hydrostatic Drive Control Handle) through the Machine Display.
Refer to “Machine Display” provided in Section 3 - Cab elsewhere in this manual for initial setup instructions.



End Row Management Switch
(Located on the Hydrostatic Drive Control Handle - Version 1)
-Typical View



End Row Management Switch
(Located on the Hydrostatic Drive Control Handle - Version 2)
-Typical View

2. On the NORAC or Ag Leader main “Run Screen”, press the “wrench” icon.



Main Run Screen
-Typical View

3. On the Settings Screen (1/3), press the “right/forward” blue arrow icon to navigate to the next screen.

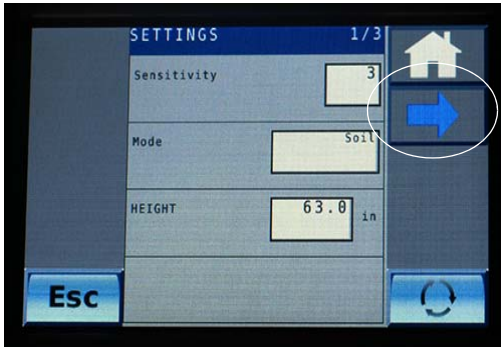

Settings Screen (1/3)
-Typical View

4. On the Settings Screen (2/3), press the “right/forward” blue arrow icon to navigate to the next screen.
5. On the Settings Screen (3/3), press the “check page” icon.



Settings Screen (3/3)
-Typical View

6. On the Options Screen (1/5), ensure the “Remove Switches” option is selected and press the “right/forward” blue arrow icon to navigate to the next screen.

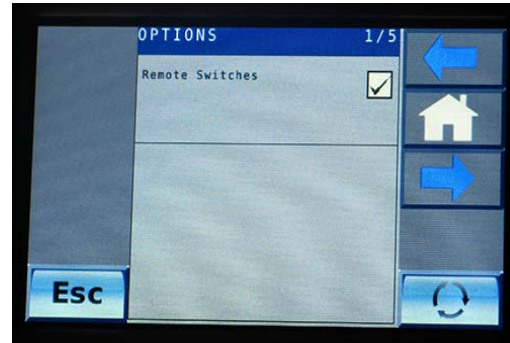

Options Screen (1/5)
-Typical View

7. On the Options Screen (2/5), select “Headland Assist”.



Options Screen (2/5)
-Typical View

8. On the Options Screen (2/5), press the selection area (next to “Headland Trigger”) and select REMOTE to enable NORAC through the End Row Management Switch.

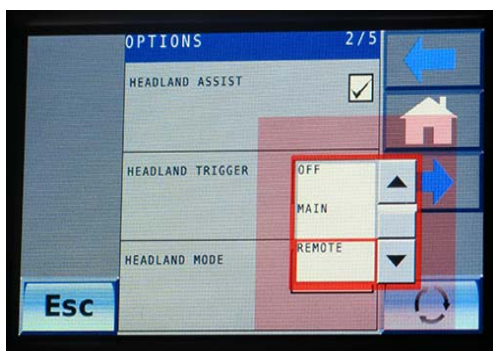

Options Screen (2/5)
 -Typical View

- On the Options Screen (2/5), press the selection area (next to “Headland Mode”) and select MAIN or WINGS.

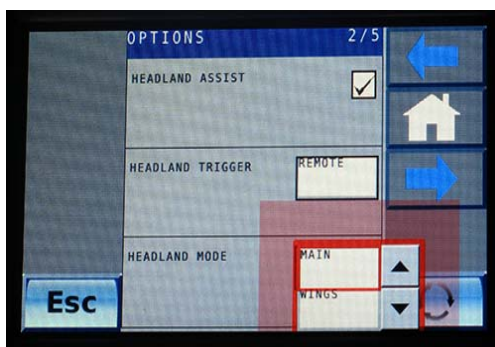

Options Screen (2/5)
 -Typical View

SPRAY BOOMS - 120/132' -If Equipped

The spray booms are controlled by an electro-hydraulic system. This system consists of operator-manipulated switches (located on the side console and the hydrostatic drive control handle) and hydraulic cylinders (attached to the booms), which provide lift, level, and horizontal extension.

⚠ CAUTION

When operating or positioning the booms, observe the following safety precautions. Failure to comply may result in injury or equipment damage.

- Do not unfold/fold boom extensions when main boom is in cradle.
- Do not operate machine with one boom out of cradle and the other boom in cradle.
- Ensure booms are folded and in cradle before transporting the machine.

⚠ WARNING

When operating or positioning the booms, observe the following safety precautions:

- Monitor both sides of the boom during fold procedure.
- Cradle booms when leaving the machine unattended.
- Ensure booms are folded when cradled.
- Select a safe area before unfolding/folding the booms.
- Clear area of personnel.
- Check for overhead obstructions.
- Do not unfold/fold booms near power lines. Contact with power lines can result in serious injury or death.
- Spray equipment is designed for FIELD USE ONLY. Do not attempt to use machinery for anything other than it's intended purpose.

⚠ WARNING

Hydraulic and electrical control systems are optimized for use of the spray boom attachment. Any modification to these systems may lead to unintended and uncontrolled motion. DO NOT install add-on control systems that are not approved by Hagie Manufacturing Company.

Power Lines

Hagie Manufacturing Company cannot stress enough that extreme caution must be taken when operating equipment near power lines. Ensure there is more than sufficient clearance when transporting, unfolding and folding the boom, or spraying near power lines.



As a safety precaution, a Power Line Warning Message will appear on the Machine Display before extending the outer boom extensions or when operating in Auto Fold. Press ACKNOWLEDGE showing that you have acknowledged that there are no overhead power lines or obstructions before proceeding.

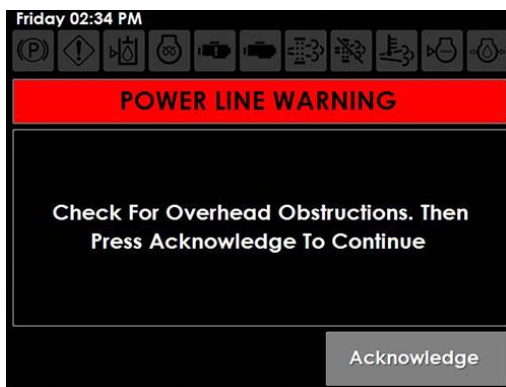

Power Line Warning Message
(Located on the Machine Display)

Hydraulically folding the extensions of a 120-ft. spray boom and shutting off the outer section valves (Boom Solution Valve Switches 1 and 9) essentially turns it into a 70-ft. boom (see the following illustrations).

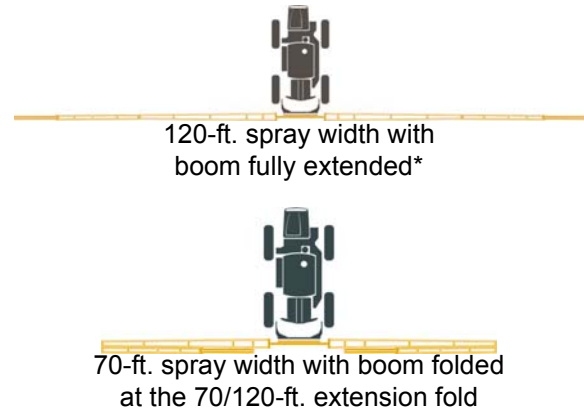

* Recommended spray width

Spray Boom Components

- Pivot Transom
- Fixed Transom
- Level Cylinders
- Roll Cylinder
- Proximity Sensors
- NORAC® Sensors
- Position Sensors
- Accumulators
- Main Pivot/Breakaway Cylinders
- Outer Breakaway (Tip)

Pivot Transom

The Pivot Transom houses work lights, solution valves, main fold cylinders, and solution plumbing.



Pivot Transom
-Typical View

Fixed Transom

The Fixed Transom and Lift Arm house the lift cylinders, pressure gauge, roll lock cylinders, boom stands, fold control

manifold, Hagie-installed modules, NORAC center sensor, and the NORAC lift/level hydraulic manifold.



Fixed Transom
-Typical View

Level Cylinders

The Level Cylinders (located on the left and right-hand side of the transom) are responsible for the up and down movement of the boom wings when the level controls are activated.

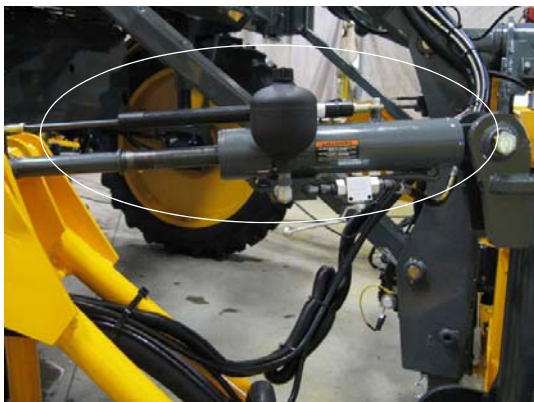

Level Cylinders
-Typical View

Roll Cylinder

The Roll Cylinders extend and retract, which provide the “roll” functions to aid in re-centering the boom for transport.

The Roll Cylinders are automatically placed into a “passive roll state” when the main booms are in the UNFOLDED position. This means the booms will be free to move on

the pendulum assembly at this point. The hydraulic valves and cylinders will not stop this from occurring.



Roll Cylinder
-Typical View

Proximity Sensors

External Proximity Sensors are located at the 70-ft. fold. The motions of the boom (folding and unfolding) are guided by the measured position of the different cylinders.

NOTE: The Proximity Sensors are factory-positioned and should not require calibration. Contact Hagie Customer Support if boom positioning assistance is needed.



Proximity Sensors
-Typical View

NORAC Sensors

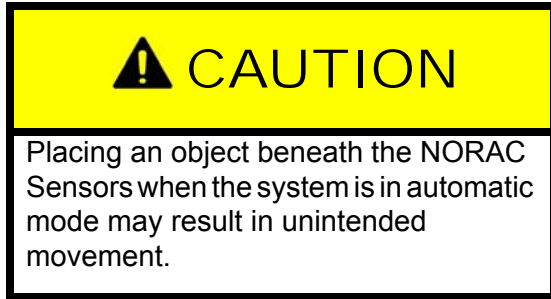

The boom is equipped with five (5) NORAC Sensors (two located at each folding section, two located on each outer boom extension, and one located on the transom) that measure boom height above ground. The sensors send a signal to the NORAC control system allowing for position corrections to keep the boom parallel to the ground and the crop, giving you a more consistent spray pattern.

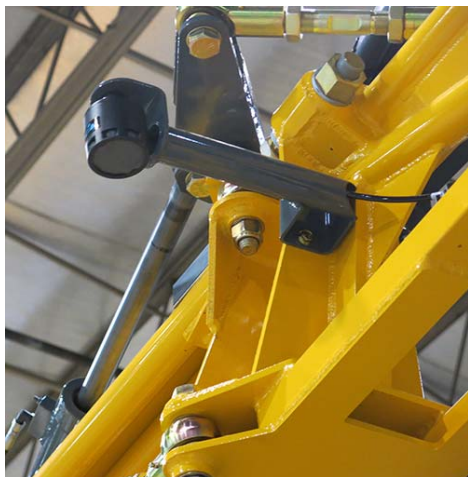

NORAC Sensor
-Typical View

Position Sensors

The level cylinders and main fold cylinders are equipped with Position Sensors. These sensors measure the linear stroke of the cylinder, allowing the boom to be positioned correctly when in Auto Fold mode.

The required specific motions exist to provide smooth, efficient operation. The programmed positions help prevent

mechanical damage to the boom due to severe imbalance, unintended contact with the ground, or improper fold sequence.

NOTE: The Position Sensors are factory-positioned and should not require calibration. Contact Hagie Customer Support if boom positioning assistance is needed.



Position Sensor
-Typical View

Accumulators



The level and lift cylinders (located on the transom) are equipped with multiple Accumulators. These Accumulators act as a “shock absorber” for the booms.



Accumulator
 -Typical View

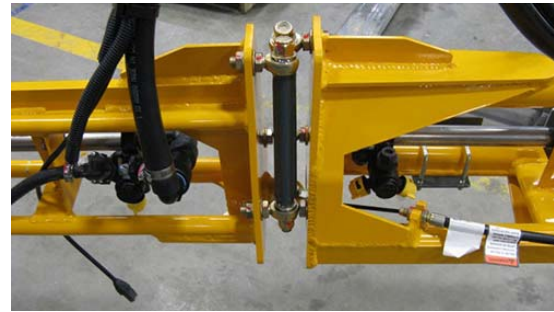

Outer Breakaway
 -Typical View

NOTE: The Outer Breakaway is self-resetting and will return to the normal operating position after it has cleared the hazard.

Main Pivot/Breakaway Cylinders

The Main Pivot/Breakaway Cylinders are responsible for the horizontal extension of the booms to the spray position. They also provide breakaway protection for the boom. These breakaway cylinders will move backward to a maximum of 45-degrees in the event that the section encounters an obstacle.



Main Pivot/Breakaway Cylinders
 -Typical View

Adjusting Breakaway Tension

Recommended tension for the spring breakaway is 18"/45.7 cm (distance from the first coil to last coil, as shown).



Spring Breakaway
 -Typical View



Outer Breakaway (Tip)

A spring breakaway (located at the tip of the boom) moves forward, backward, and up to provide protection of the boom by allowing the boom to fold forward or backward in the event that it were to come into contact with another object.

To increase/decrease spring tension:

- Using a 15/16" wrench or socket, loosen the Jam Nut.
- Using a 15/16" wrench or socket, tighten the Adjust Nut to extend the spring, or loosen the Adjust Nut to retract the spring.
- Re-tighten Jam Nut.

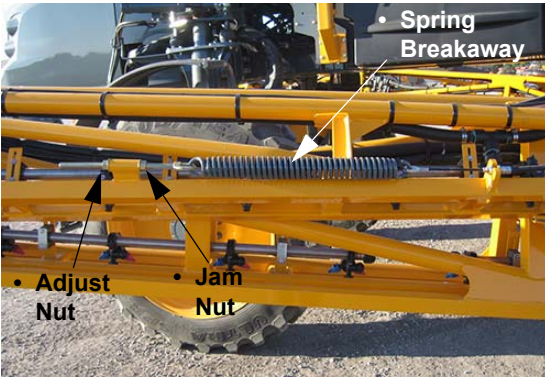

Spring Breakaway Adjust/Jam Nuts
(Located near the outer
end of the spring breakaway)
-Typical View

Recharging Breakaway Circuits Main Pivot/Breakaway Cylinders (Auto/Manual Mode)

To recharge Breakaway Circuits in Auto/Manual Mode, press the corresponding Left or Right-Hand Boom Switch (located on the Hydrostatic Drive Control Handle) in the OUT position.

NOTE: Right Extend OUT will recharge the breakaway circuits on the right-hand side of boom. Left Extend OUT will recharge the breakaway circuits on the left-hand side of boom.

Auto Fold

The Auto Fold feature is the preferred method for unfolding/folding the spray boom and makes operation of the machine easier for the operator.

NOTE: Ensure the Hydrostatic Drive Control Handle is in the NEUTRAL or PARK position. If the machine is put in gear during fold operation, boom movement will stop.

1. Press the Boom State Button (located on the Machine Display Auxiliary Controls Page) to the AUTO position.

NOTE: The selected boom state will illuminate.

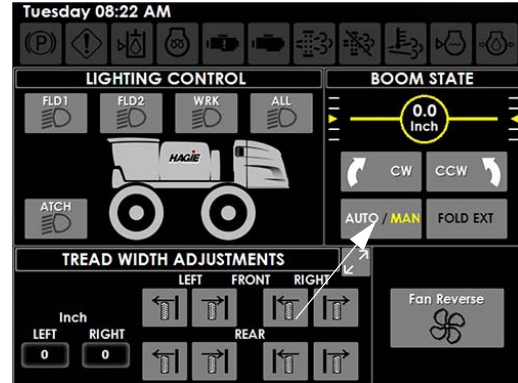

Boom State Button - Auto/Manual
(Located on the Machine Display
Auxiliary Controls Page)

2. Press the Fold Extension Button (located on the Machine Display Auxiliary Controls Page) to the ON (illuminated) position to enable Auto Fold operation of the outer boom extensions.

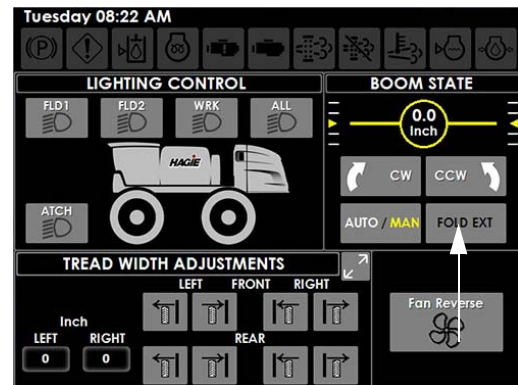

Fold Extension (Ext) Button
(Located on the Machine Display
Auxiliary Controls Page)

When the boom state displays AUTO and the Fold Extension Button is enabled, the boom will operate with the Boom Extension Switches (located on the side console).

NOTE: When the Fold Extension Button is disabled, the main boom will unfold/fold, but the outer boom extensions will not.

3. Press and hold **both** Left and Right Boom Extension Switches (located on the side console) UP to unfold the boom

to the fully extended position on all sections.

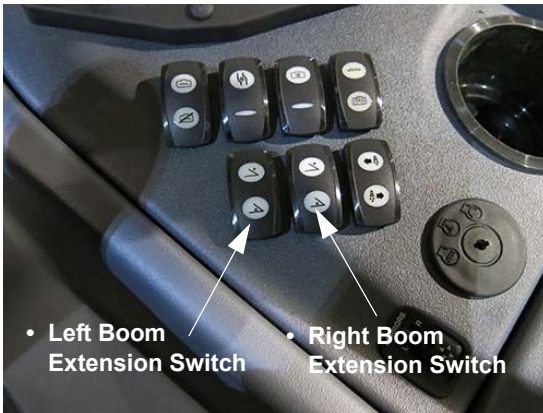

Left and Right Boom Extension Switches
(Located on the side console)
-Typical View

4. Press and hold **both** Left and Right Boom Extension Switches (located on the side console) **DOWN** to fold the boom in to the fully retracted position.

Manual Unfold (OUT)

NOTICE

Do not lower the main lift while the boom is in cradle. Failure to comply will result in property damage.

NOTE: Ensure the Hydrostatic Drive Control Handle is in the NEUTRAL or PARK position. If the machine is put in gear during fold operation, boom movement will stop.

1. Press the Boom State Button (located on the Machine Display Auxiliary Controls Page) to the MANUAL position.

NOTE: The selected boom state will illuminate.

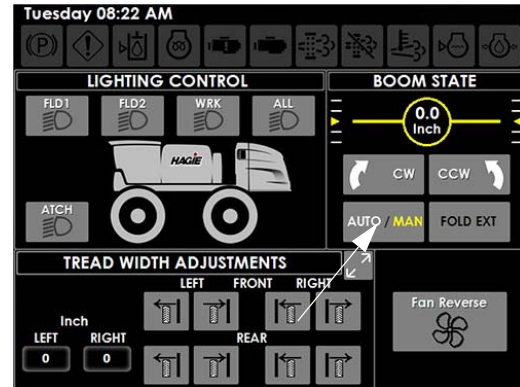

Boom State Button - Auto/Manual
(Located on the Machine Display Auxiliary Controls Page)

2. Press and hold the corresponding Left and Right-Hand Boom Switches (located on the Hydrostatic Drive Control Handle) in the UP position to raise the level cylinders all the way up.



Left and Right-Hand Boom Switches
(Located on the Hydrostatic Drive Control Handle - Version 1)
-Typical View



Left and Right-Hand Boom Switches
(Located on the Hydrostatic Drive
Control Handle - Version 2)
-Typical View

3. Press and hold the Left and Right-Hand Boom Switches in the OUT position to unfold the main boom sections until they come to a complete stop.

NOTE: Unfold booms simultaneously to prevent weight imbalance.

4. Lower the level cylinders until the boom is parallel with the ground.
5. Press and hold the Left and Right Boom Extension Switches (located on the side console) in the UP position to unfold the boom extensions all the way OUT.

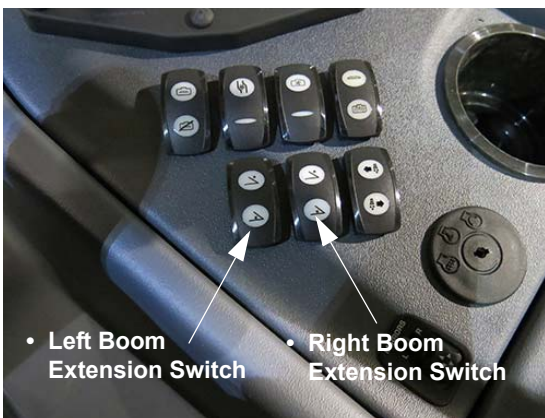

Left and Right Boom Extension Switches
(Located on the side console)
-Typical View

Manual Fold (IN)

NOTE: Ensure the Hydrostatic Drive Control Handle is in the NEUTRAL or PARK position. If the machine is put in gear during fold operation, boom movement will stop.

1. Press the Boom State Button (located on the Machine Display Auxiliary Controls Page) to the MANUAL position.

NOTE: The selected boom state will illuminate.

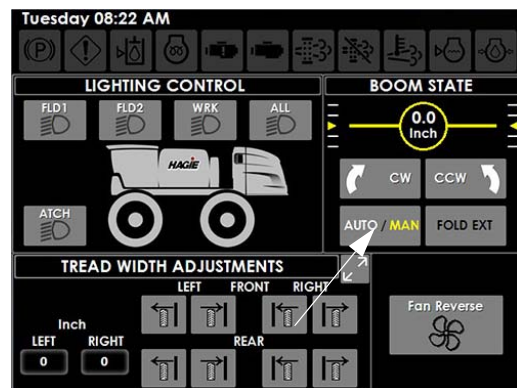

Boom State Button - Auto/Manual
(Located on the Machine Display
Auxiliary Controls Page)

2. Lower the level cylinders until the boom is parallel with the ground.
3. Press and hold the Left and Right Boom Extension Switches (located on the side console) in the DOWN position to fold the boom extensions all the way IN.

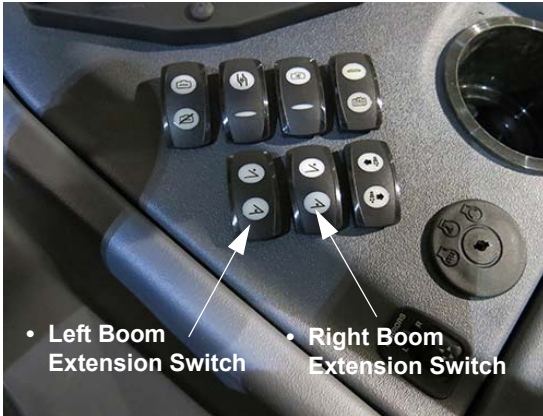

Left and Right Boom Extension Switches
(Located on the side console)
-Typical View

4. Raise the level cylinders all the way up.
5. Press and hold the Left and Right-Hand Boom Switches (located on the Hydrostatic Drive Control Handle) in the IN position until the main boom wings are aligned with cradles.

NOTE: Fold booms simultaneously to prevent weight imbalance.



Left and Right-Hand Boom Switches
(Located on the Hydrostatic Drive Control Handle - Version 1)
-Typical View



Left and Right-Hand Boom Switches
(Located on the Hydrostatic Drive Control Handle - Version 2)
-Typical View

6. Lower the level cylinders until the boom sections are seated in the boom cradles.

Boom Alignment

When operating boom functions, the Boom Alignment value may be viewed on the Machine Display Auxiliary Controls Page.

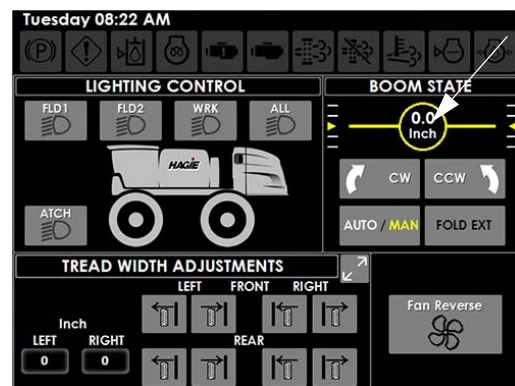

Boom Alignment Value
(Located on the Machine Display Auxiliary Controls Page)

Rolling Boom

The Rolling Boom feature will enable the boom to roll either “clockwise” or “counter-clockwise” (as viewed from the cab) using the Roll Command Buttons (located on the Machine Display Auxiliary Controls Page).

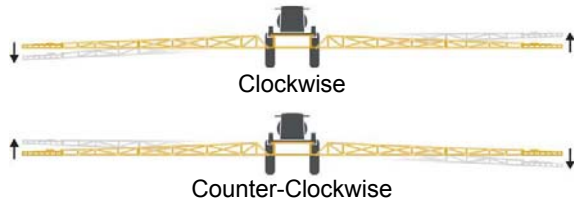

- Press and hold the “CW” Roll Command Button to roll the boom “clockwise”.
- Press and hold the “CCW” Roll Command Button to roll the boom “counter-clockwise”.

NOTE: The Roll Command Buttons will illuminate when held in the ON position and the current boom alignment value will be displayed.

- When either of the CW or CCW Roll Command Buttons are released, the boom will return to the neutral (center) position.

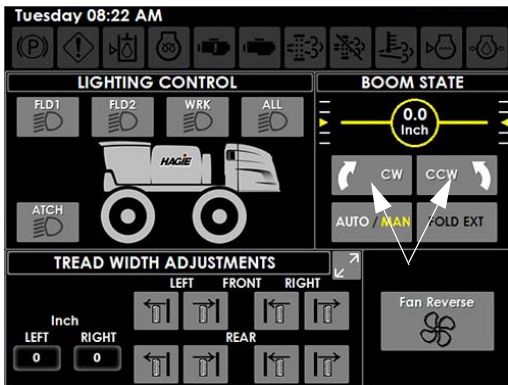

Roll Command Buttons (CW/CCW)
(Located on the Machine Display
Auxiliary Controls Page)

NOTE: Center position value is 0 inches/cm.

Enabling/Disabling NORAC® in the Pulse Display

-If Equipped

NOTE: Hagie Manufacturing Company recommends turning the NORAC Monitor OFF when traveling from one field to the next. A power switch is located on the back side of the monitor.



NORAC Monitor
-Typical View

- **To Enable**, press the corresponding Auto or Manual Button (located on the main “Run Screen”) to the ON (green illuminated position).

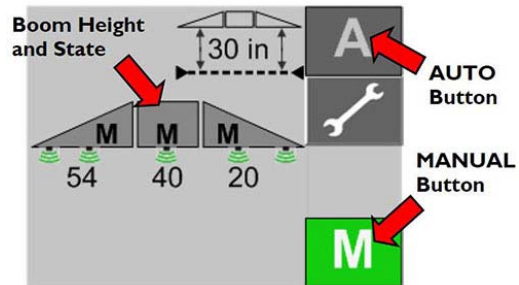

Auto/Manual Buttons - NORAC
(Located on the main “Run Screen”)
-Typical View

** Your monitor may vary in appearance, depending on model*

- **To Disable**, press the corresponding Auto or Manual Button to the OFF (gray) position or press any one of the following boom control switches (located on the Hydrostatic Drive Control Handle):

- Transom Switch (Up/Down)
- Left or Right-Hand Boom Switch (Up/Down)

NOTE: If the NORAC System becomes inoperable, the Auto and Manual Fold functions will still operate.

Enabling/Disabling NORAC in the Ag Leader® Display

-If Equipped

- **To Enable**, press the Auto/Manual Button (located on the main “Run Screen”) to the ON (green illuminated position).

NOTE: When the system is engaged, the boom image will change from black to blue.



Auto/Manual Button - Ag Leader
(Located on the main “Run Screen”)
-Typical View

** Your monitor may vary in appearance, depending on model*

- **To Disable**, press the Auto/Manual Button to the OFF (white) position or press any one of the following boom control switches (located on the Hydrostatic Drive Control Handle):
 - Transom Switch (Up/Down)
 - Left or Right-Hand Boom Switch (Up/Down)

NOTE: When the system is disabled, the boom image will change from blue to black.

NOTE: If the NORAC System becomes inoperable, the Auto and Manual Fold functions will still operate.

NORAC/Ag Leader System Settings

-If Equipped (Soil/Crop Mode, Target Height, and Sensitivity)

NOTE: Settings may be adjusted through the main Run Screen by pressing the Boom Image or the Settings Button (wrench icon), depending on model. Refer to the NORAC or Ag Leader manufacturer’s operation manual for further information.

Soil/Crop Mode

Soil Mode allows the sensors to read the height from the spray nozzles to the ground. Crop Mode allows the sensors to read the height from the spray nozzles to the top of the crop canopy.

On the NORAC Pulse Monitor:

- Press the Settings Button (wrench icon) (located on the main “Run Screen”) to navigate to the Settings Screen.
- Press the Next Button (located next to “Mode”) and select Soil, Crop, or Hybrid Mode.

NOTE: Hybrid Mode is an improved Crop Mode, which uses a combination of the crop and soil readings to improve control. This setting is recommended in place of Crop Mode.

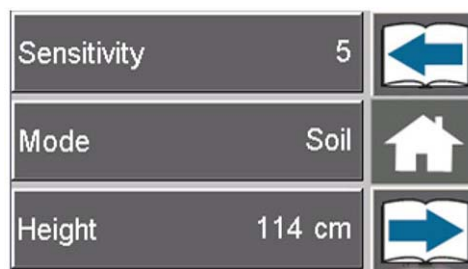

Settings Screen
(NORAC)
-Typical View

** Your monitor may vary in appearance, depending on model*

On the Ag Leader Monitor:

- Press the Boom Image (located on the main “Run Screen”).
- Press the top drop-down arrow (located on the Boom Height Control Options Screen) and select Soil or Crop Mode.

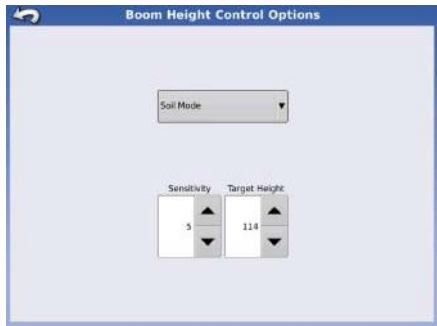

Boom Height Control Options Screen
 (Ag Leader)
 -Typical View

** Your monitor may vary in appearance, depending on model*

Sensitivity

Sensitivity is how responsive the system is. The lower the number, the lower the sensitivity. The higher the number, the higher the response time and hydraulic demand.

NOTE: Default sensitivity setting is 5.

On the NORAC Pulse Monitor:

- Press the Settings Button (wrench icon) (located on the main “Run Screen”) to navigate to the Settings Screen.
- Press the Next Button (located next to “Sensitivity”) and increase or decrease system sensitivity values from 1-10.

On the Ag Leader Monitor:

- Press the Boom Image (located on the main “Run Screen”).
- Press the Sensitivity Buttons (located on the Boom Height Control Options Screen) and increase or decrease system sensitivity values from 1-10.

Target Height

Target Height is the height you desire the boom to be set at when spraying.

NOTE: When operating in Soil Mode, the Target Height is measured from the spray nozzles to the soil. In Crop Mode, the target height is measured from the crop canopy to the spray nozzles.

On the NORAC Pulse Monitor:

- Press the Settings Button (wrench icon) (located on the main “Run Screen”) to navigate to the Settings Screen.
- Press the Next Button (located next to “Height”) and increase or decrease values to desired boom height.

On the Ag Leader Monitor:

- Press the Boom Image (located on the main “Run Screen”).
- Press the Target Height Buttons (located on the Boom Height Control Options Screen) and increase or decrease values to desired boom height.

Further Information

Refer to the NORAC or Ag Leader manufacturer’s operation manual for complete operating/calibration instructions, troubleshooting information, and safety precautions.

Refer to “Specifications” provided in the *Introduction Section* elsewhere in this manual for information on GPS dimensions on your machine.

Enabling NORAC through the End Row Management Switch

-If Equipped
(Typical View - appearance may vary, depending on model)

1. Program the End Row Management Switch (located on the Hydrostatic Drive Control Handle) through the Machine Display.
Refer to “Machine Display” provided in Section 3 - Cab elsewhere in this manual for initial setup instructions.



End Row Management Switch
(Located on the Hydrostatic Drive
Control Handle - Version 1)
-Typical View



End Row Management Switch
(Located on the Hydrostatic Drive
Control Handle - Version 2)
-Typical View

2. On the NORAC or Ag Leader main “Run Screen”, press the “wrench” icon.



Main Run Screen
-Typical View

3. On the Settings Screen (1/3), press the “right/forward” blue arrow icon to navigate to the next screen.



Settings Screen (1/3)
-Typical View

4. On the Settings Screen (2/3), press the “right/forward” blue arrow icon to navigate to the next screen.
5. On the Settings Screen (3/3), press the “check page” icon.



Settings Screen (3/3)
-Typical View

- On the Options Screen (1/5), ensure the “Remove Switches” option is selected and press the “right/forward” blue arrow icon to navigate to the next screen.

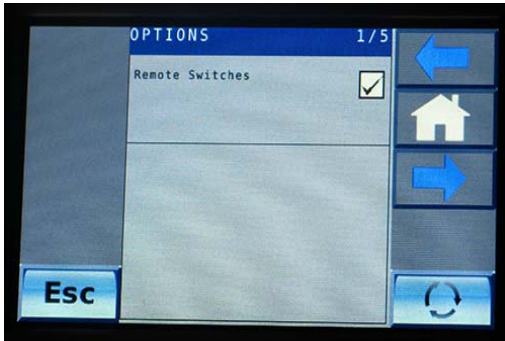

Options Screen (1/5)
-Typical View

- On the Options Screen (2/5), select “Headland Assist”.



Options Screen (2/5)
-Typical View

- On the Options Screen (2/5), press the selection area (next to “Headland Trigger”) and select REMOTE to enable NORAC through the End Row Management Switch.

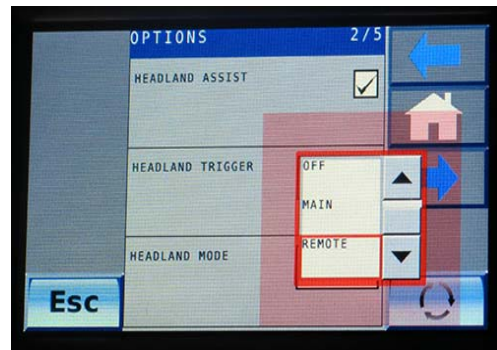

Options Screen (2/5)
-Typical View

- On the Options Screen (2/5), press the selection area (next to “Headland Mode”) and select MAIN or WINGS.

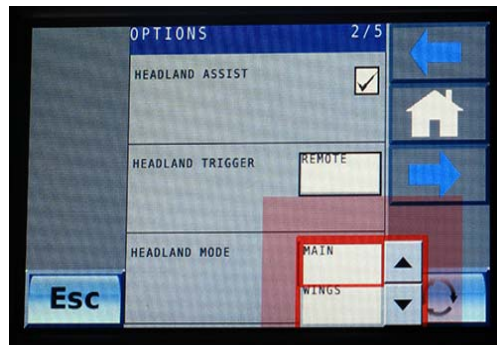

Options Screen (2/5)
-Typical View

SPRAY BOOM - REAR

-If Equipped

NOTE: The Rear Spray Boom is controlled through the center spray section of the front boom.

Installing the Rear Boom

- Route solution line from the front boom to the rear boom (A).

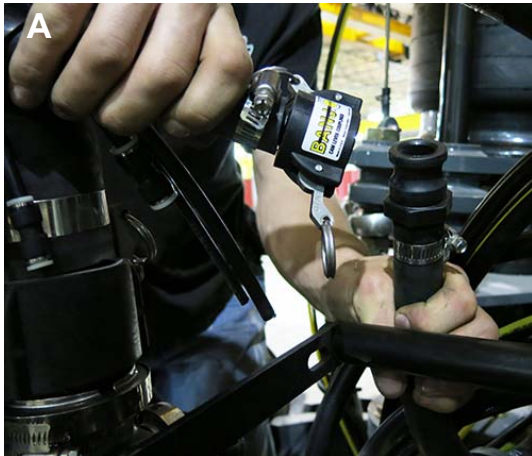

-Typical View

2. Rotate the 3-Way Boom Valve (B) (located on the center spray section of the front boom) to supply solution to the rear boom.
 - Rotate valve towards front of machine to supply solution to the front boom.
 - Rotate valve in the upright (vertical) position to shut solution supply OFF.
 - Rotate valve towards rear of machine to supply solution to the rear boom.

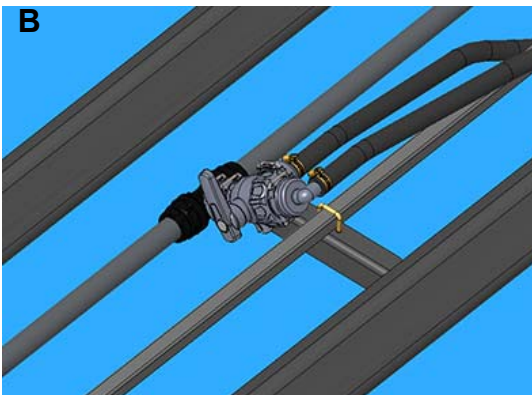

-Typical View

3. Slide the Rear Spray Boom (C) into the Boom Mounting Brackets (D), located on each side of the rear bumper.



-Typical View

4. Slide the boom mounting hardware (E) inside the boom tubing, ensuring holes are aligned.

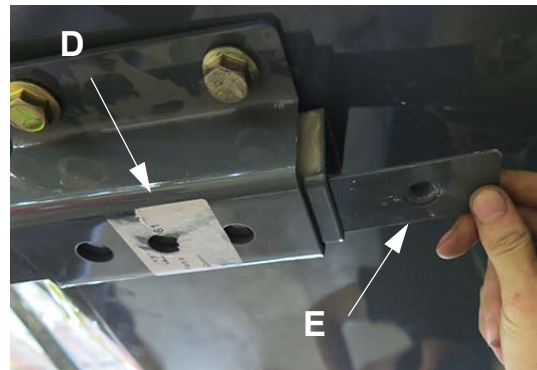

-Typical View

5. Using a 3/4" wrench, bolt the Rear Spray Boom to the Boom Mounting Brackets, bolting through the wall of the boom (F).

NOTE: Install two (2) bolts on each side of boom mounting assembly.



-Typical View

6. Connect the solution line with the quick-connect fittings (located beneath right-hand side of machine).

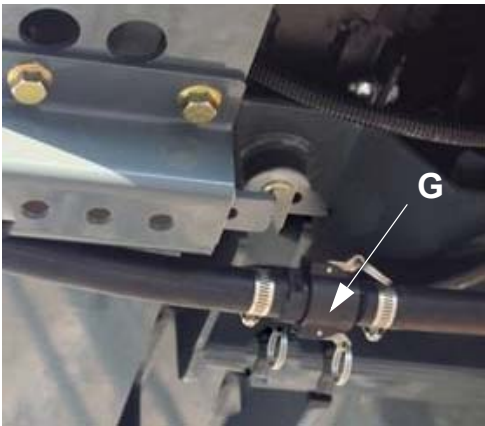

-Typical View

7. The Rear Spray Boom is now ready for use.

Removing the Rear Boom

1. Disconnect the solution line from the quick-connect fittings (G).
2. Unbolt the Rear Spray Boom (C) from the Boom Mounting Brackets (D).
3. Remove the Rear Spray Boom and set aside.
4. Route and reconnect solution line to the front boom.
5. Rotate the 3-Way Boom Valve to the HORIZONTAL position to route solution flow to the front boom.

SOLUTION SYSTEM COMPONENTS

The Solution System is a constantly monitored, continuously adjusted computer-controlled system. The cab-mounted digital spray system console receives information from various inputs to help determine gallons per acre (GPA)/liters per hectare (l/ha) and gallons per minute (GPM)/liters per minute (l/min).

Please read and understand the information provided in this manual, as well as the spray system console manufacturer's

operation manual before operating the Solution System. The following information refers to components of the Solution System and is not intended to replace the manufacturer's operating instructions.

- Solution Tank
- Solution Pump
- Solution Pump Switch
- Flow Meter
- Pressure Gauge
- Solution Tank Drain Valve
- Solution Tank Valve
- Main Tank Valve Switch
- Agitation Valve
- Agitation Valve Switch
- Jet Agitators
- Boom Solution Valve Switches
- Section Indicator Display
- Boom Solution Valve Indicators (Transom), if equipped
- Rate Control Switches
- Pump Speed/Rate Switches
- Master Spray Switch
- Spray System Console

Solution Tank



Solution Tank
-Typical View

Solution Pump

The Solution Pump (located near center of machine) is a centrifugal-type hydraulic pump that is controlled by the Solution Pump Control Valve and the Spray System Console.

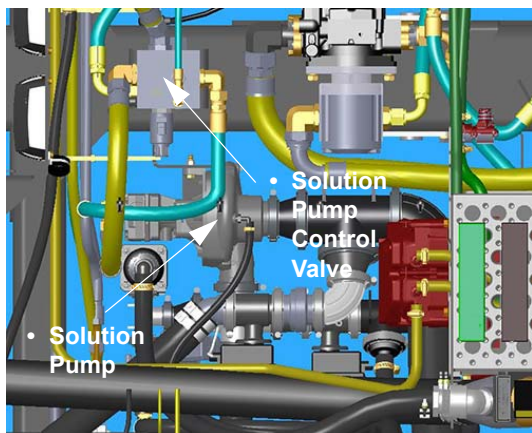

Solution Pump and
Solution Pump Control Valve
(Located near center of machine)
-Typical View

* View shown from top of machine

The Solution Pump draws solution out of the tank at the rate determined during calibration. It dispenses solution through the many valves and hoses that make up the Spray System. The Solution Pump also dispenses fluids through the Agitation and Rinse Systems.

Refer to the Spray System Console manufacturer's operation manual for further information on solution pump control.

Solution Pump Switch

The Solution Pump Switch (located on the side console) is used to turn on/off the Solution Pump.

NOTE: Leaving the Solution Pump Switch in the ON position can cause the pump to run continuously, which may result in system damage.

- Press the Solution Pump Switch in the UP position to turn ON (enable).
- Press the Solution Pump Switch in the DOWN position to turn OFF (disable).



Solution Pump Switch
(Located on the side console)
-Typical View

NOTE: When the Solution Pump is ON, a Solution Pump Indicator (located on the Machine Display Home Page - Field Mode) will illuminate.



Solution Pump Indicator
(Located on the Machine Display
Home Page - Field Mode)

Flow Meter

The Flow Meter (located beneath the right-hand side of machine) monitors the solution flow and sends information back to the Spray System Console.

NOTE: Flow Meter Calibration = 378 pulses/per gallon (standard volume system).

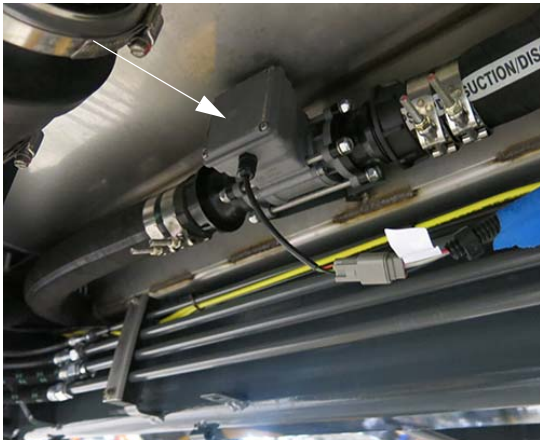

Flow Meter
(Located beneath the
right-hand side of machine)
-Typical View

Pressure Gauge

The Pressure Gauge (mounted on the boom) gives a constant visual display of solution pressure being applied (measured in PSI).

NOTE: Pressure will vary according to speed, application, rate, tip size, etc.



Pressure Gauge
(Mounted on boom)
-Typical View

Solution Tank Drain Valve

The Solution Tank Drain Valve (located beneath the solution tank on underside of machine) is used to drain small volumes of residual from the solution tank.

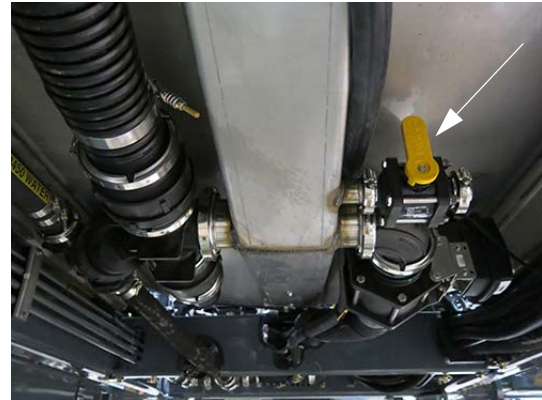

Solution Tank Drain Valve
(Located beneath the solution
tank on underside of machine)
-Typical View

Refer to “Draining Your Solution Tank” elsewhere in this section for further information.

Solution Tank Valve (Main Tank)

The Solution Tank Valve (located beneath the solution tank on underside of machine) is an electric tank shut-off valve. This valve is controlled by the Main Tank Valve Switch (located on the side console).



Solution Tank Valve
(Located beneath the solution
tank on underside of machine)
-Typical View

Main Tank Valve Switch

The Main Tank Valve Switch (located on the side console) controls the Solution Tank Valve.

- Press the Main Tank Valve Switch UP to open. Press switch DOWN to close.



Main Tank Valve Switch
(Located on the side console)
-Typical View

NOTE: Main Tank Valve status (OPEN or CLOSED) is displayed on the Machine Display Home Page - Field Mode.

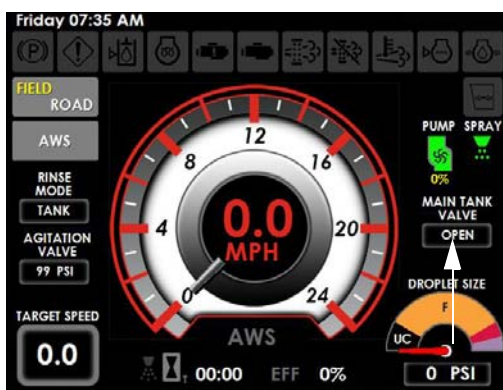

Main Tank Valve Status Indicator
(Located on the Machine Display
Home Page - Field Mode)

Agitation Valve

The flow rate of the Agitation System is controlled by an Agitation Valve (located near center of machine) to thoroughly mix solution in the tank and regulate pressure and flow to the Jet Agitators. Increase or decrease agitation flow by operating the Agitation Valve Switch (located on the side console).



Agitation Valve
(Located near center of machine)
-Typical View
** View shown from top of machine*

Agitation Valve Switch

The Agitation Valve Switch (located on the side console) controls agitation flow rate.



Agitation Valve Switch
(Located on the side console)
-Typical View

- **To increase flow**, press and hold the Agitation Valve Switch in the UP position.
- **To decrease flow**, press and hold the Agitation Valve Switch in the DOWN position.
- Release the Agitation Valve Switch when desired rate of flow is achieved.
- To turn the Agitation System OFF, decrease the flow rate all the way down.

NOTE: Agitation Valve pressure is displayed on the Machine Display Home Page - Road and Field Mode.



Agitation Valve Pressure Indicator
(Located on the Machine Display Home Page - Road and Field Mode)

Jet Agitators (2)

The Jet Agitators (located on each end of the solution tank) are an integral part of the Agitation System. 1/4” nozzles are located on the end of each Jet Agitator (inside of the solution tank) and provide ample agitation and solution suspension.

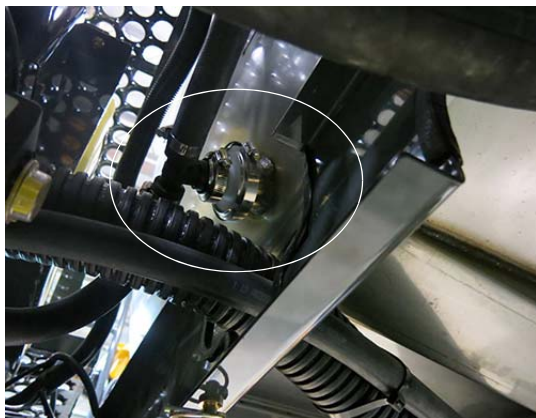

Jet Agitator
(Located on each end of the solution tank)
-Typical View

Boom Solution Valve Switches

The spray booms are divided into sections that are independently supplied with solution and can be turned on or off individually. The electrically-operated Boom Solution Valves are controlled by the Boom Solution Valve Switches (located on the side console).

- Press the Boom Solution Valve Switches to turn ON. Press again to turn OFF.

NOTE: Each Boom Solution Valve Switch is equipped with an indicator light and will illuminate when the corresponding Boom Solution Valve is OFF.



Boom Solution Valve Switches
(Located on the side console)
-Typical View

Section Indicator Display

The Section Indicator Display (located on the cab headliner) allows you to view system status for the following:

- (1) - Master Spray Indicator (illuminates when ON).
- (2) - Fence Row Indicators (illuminate when ON).
- (9) - Spray Section Indicators (illuminate when OFF).
- (1) - Rear Wheel Nozzle Indicator (illuminates when ON).

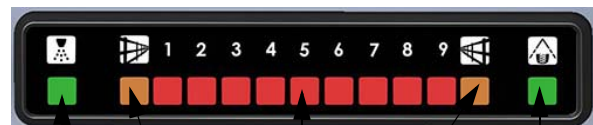

- Master Spray
- Left Fence Row
- Spray Section
- Right Fence Row
- Rear Wheel Nozzle

Section Indicator Display
(Located on the cab headliner)
-Typical View

Boom Solution Valve Indicators (Transom)

-If Equipped

Your machine may be equipped with transom-mounted Boom Solution Valve Indicators (located on the center of the transom), which allow you to view system status for the following:

- (2) - Fence Row Indicators (illuminate when ON).
- (1) - Master Spray Indicator (illuminates when ON).
- (9) - Spray Section Indicators (illuminate when OFF).



Boom Solution Valve Indicators
(Located on transom)
-Typical View

Rate Control Switches

The Rate Control Switches (located on the side console) control the rate in which solution is applied through the spray booms.

- Press ENABLE to allow the rate controller to control the application rate.
- Press MAN (Manual) to control application rate from the section keypad.
- Press ENABLE and MAN to enable manual rate control through the rate controller.



Rate Control Switches
(Located on the side console)
-Typical View

NOTE: When “MAN” is selected, press the Pump Speed/Rate Switches (located on the side console) to increase (+) or decrease (-) application rate. Current solution pump speed is displayed below the Solution Pump Indicator (located on the Machine Display Home Page - Field Mode).

Pump Speed/Rate Switches

The Pump Speed/Rate Switches (located on the side console) control the flow rate through the spray system.

NOTE: These switches are enabled when the “MAN” Rate Control Switch (located on the side console) is previously selected.

- Press “+” to INCREASE Solution Pump speed.
- Press “-” to DECREASE Solution Pump speed.



Pump Speed/Rate Switches
(Located on the side console)
-Typical View

NOTE: Increasing or decreasing pump speed will change the application rate through the rate controller.

Master Spray Switch

Boom Solution Valve Switches are controlled by the Master Spray Switch (located on the Hydrostatic Drive Control Handle) and must be ON to open the electronically-operated Boom Solution Valves.

This allows you to turn all of the Boom Solution Valves on or off at the same time, such as turning them off when you reach the end rows, and turning them back on when you re-enter the field.



Master Spray Switch
(Located on the back side of the Hydrostatic Drive Control Handle - Version 1)
-Typical View



Master Spray Switch
(Located on the Hydrostatic Drive Control Handle - Version 2)
-Typical View

NOTE: When the Master Spray Switch is ON, a Master Spray Indicator (located on the Machine Display Home Page - Field Mode) will illuminate.



Master Spray Indicator
(Located on the Machine Display
Home Page - Field Mode)

Spray System Console

Refer to the Spray System Console manufacturer's operation manual for complete calibration and operating instructions.



Spray System Console
-Typical View

(The Spray System Console on your machine may vary according to model and available equipment)

SOLUTION SYSTEM - OPERATION

NOTICE

The Solution System has been tested using RV-type antifreeze. Fill solution tank with fresh water and drain before initial use.

NOTICE

Never attempt to operate the spray system without solution in the tank. Failure to comply will cause severe equipment damage and will void the warranty.

NOTE: Ensure the Master Spray Switch (located on the Hydrostatic Drive Control Handle) is in the OFF position before activating the Solution Pump Switch or the Boom Solution Valve Switches, unless you are ready to begin spray application.

Getting Started

1. Calibrate the Spray System Console (refer to the manufacturer's operation manual for calibration instructions).
2. Ensure there is adequate amount of solution in the tank.
3. Engage the parking brake.
4. Start the engine.
5. Press the Field/Road Button (located on the Machine Display Home Page) and change the machine's drive state to FIELD.

NOTE: The drive state of the machine cannot be changed unless the Hydrostatic Drive Control Handle is in the NEUTRAL position (and machine speed is less than 0.5 mph/ 0.8 km/h).



Field/Road Button
(Located on the
Machine Display Home Page)

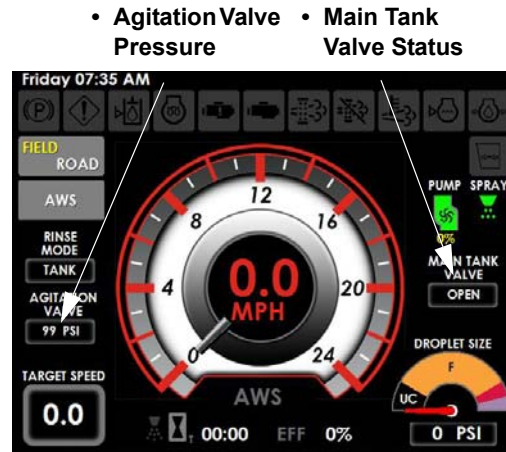

Main Tank Valve Status and
Agitation Valve Pressure Indicators
(Located on the Machine Display
Home Page - Field Mode)

NOTE: The selected drive state will illuminate.

6. Press the Main Tank Valve Switch (located on the side console) in the UP (Open) position.
If desired, activate the Agitation Valve Switch (located on the side console). Press and hold switch UP to increase flow, or DOWN to decrease flow.

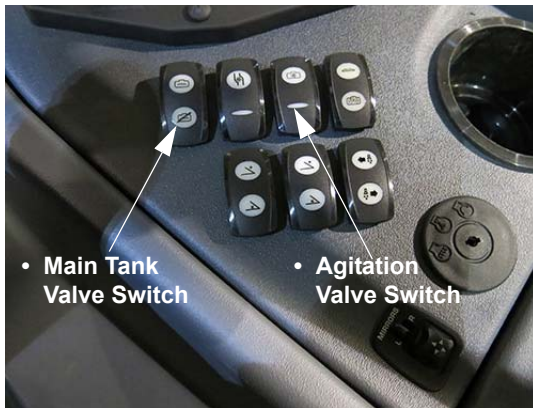

Main Tank and Agitation Valve Switches
(Located on the side console)
-Typical View

7. Press desired Rate Control Switch (located on the side console).
 - Press ENABLE to allow the rate controller to control application rate.
 - Press MAN (Manual) to control application rate from the section keypad.
 - Press ENABLE and MAN to enable manual rate control through the rate controller.

NOTE: When “MAN” is selected, press the Pump Speed/Rate Switches (located on the side console) to increase (+) or decrease (-) application rate. Current solution pump speed is displayed below the Solution Pump Indicator (located on the Machine Display Home Page - Field Mode).

NOTE: Increasing or decreasing pump speed will change the application rate through the rate controller.

NOTE: Main Tank Valve status (OPEN or CLOSED) and Agitation Valve pressure are displayed on the Machine Display Home Page (Field Mode).

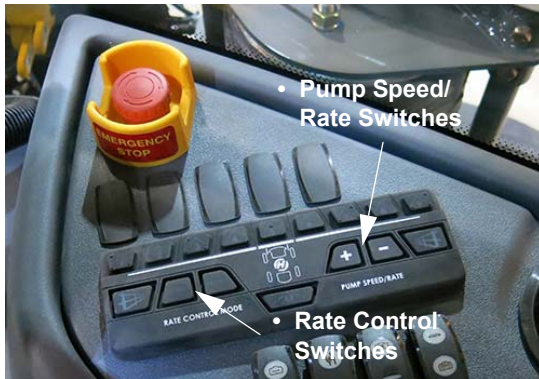

Rate Control and
Pump Speed/Rate Switches
(Located on the side console)
-Typical View

8. Press the Solution Pump Switch (located on the side console) in the UP (On) position.



Master Spray Switch
(Located on the back side of the Hydrostatic
Drive Control Handle - Version 1)
-Typical View

NOTICE

Do not allow the Solution Pump to run continuously while the Boom Solution Valve Switches are off. Failure to comply will generate overheating, causing severe pump damage and will void the warranty.



Solution Pump Switch
(Located on the side console)
-Typical View

9. Turn the Master Spray Switch (located on the Hydrostatic Drive Control Handle) ON.



Master Spray Switch
(Located on the Hydrostatic Drive
Control Handle - Version 2)
-Typical View

NOTE: When the Master Spray Switch is ON, a Master Spray Indicator (located on the Machine Display Home Page - Field Mode) will illuminate.

and Agitation Valve Switches until solution is refilled.

DROPLET MONITORING SYSTEM

NOTE: Apply chemicals as recommended by the manufacturer. Refer to the chemical manufacturer's label for further information.

Your machine is equipped with a Droplet Monitoring System, which monitors droplet size (based on spray tip size and pressure). Selecting the appropriate spray tip size and pressure allows for optimal field coverage, or the prevention of spray leaving a target area.

Spray tips that produce fine droplets are typically recommended for post-emergence applications, which require excellent coverage on the desired area. Spray tips that produce coarse or medium size droplets are typically used for contact and systemic herbicides, pre-emergence surface-applied herbicides, insecticides, and fungicides.

A Droplet Size Indicator (located on the Machine Display Home Page - Field Mode) displays current droplet size and solution operating pressure.



Master Spray Indicator
(Located on the Machine Display Home Page - Field Mode)

10. Press the individual Boom Solution Valve Switches (located on the side console) to the ON (non-illuminated) position.

NOTE: Each Boom Solution Valve Switch is equipped with an indicator light and will illuminate when the corresponding Boom Solution Valve is OFF.



Boom Solution Valve Switches
(Located on the side console)
-Typical View

11. Slowly move the Hydrostatic Drive Control Handle forward to obtain desired ground speed.
12. Frequently observe the pressure gauge. If the pressure drops to zero or spray pattern deteriorates, turn OFF the Master Spray, Solution Pump, Main Tank Valve,

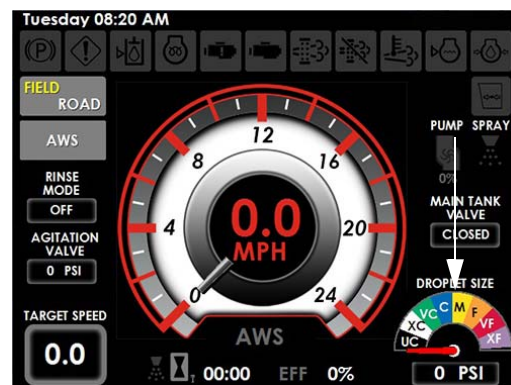

Droplet Size Indicator
(Located on the Machine Display Home Page - Field Mode)

NOTE: One spray tip can produce different droplet sizes at different pressures (e.g. A spray tip may produce

medium droplets at low pressures, while producing fine droplets at higher pressures).

Droplet Size Classification

- **XF** - Extra Fine
- **VF** - Very Fine
- **F** - Fine
- **M** - Medium
- **C** - Coarse
- **VC** - Very Coarse
- **XC** - Extra Coarse
- **UC** - Ultra Coarse

Spray Tip Selection

To Change Spray Tip Size

- Press the Spray Tip Button (located on the Machine Display Settings Page).

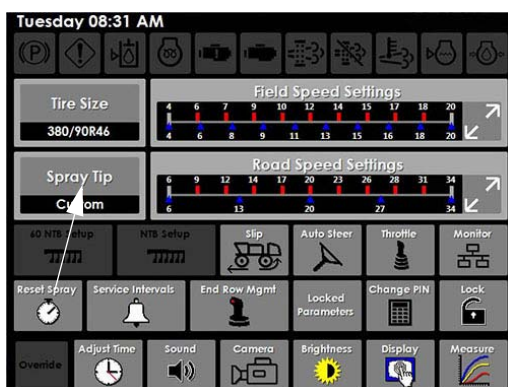

Spray Tip Button
(Located on the Machine Display Settings Page)

- On the “Spray Tip” screen, select the first part of desired spray tip.

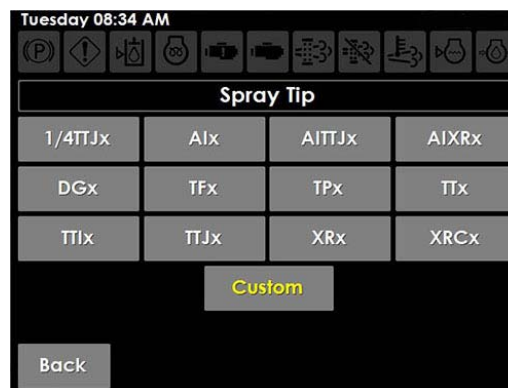

Spray Tip Screen

- Select the corresponding spray tip size.
- Press OK.

Custom Spray Tip Selection

- Press the Spray Tip Button (located on the Settings Page).
- On the “Spray Tip” screen, press the Custom Button.
- On the “Press to Select Droplet Size(s)” screen, select desired droplet size ranges.

NOTE: Droplet size ranges may be selected by pressing each droplet size individually, or by pressing and dragging desired selections.

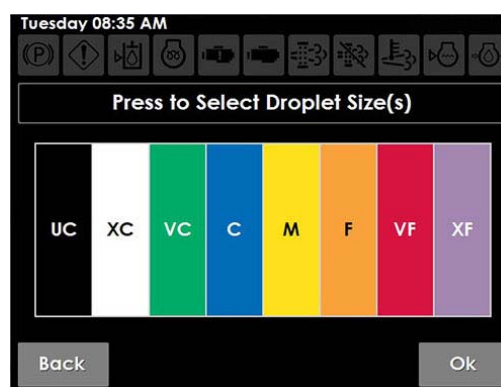

Press to Select Droplet Size(s) Screen

- Press OK.
- On the “Enter Pressures for Selected Droplet” screen, navigate to desired droplet size indicator (previously selected) using the Left/Right Arrow Buttons.

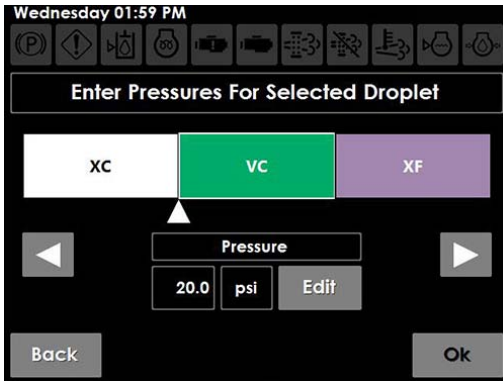

Enter Pressure for Selected Droplet Screen

- When the corresponding droplet size indicator is selected, press EDIT.
- Enter desired pressure value (break-point), then press OK.

NOTE: Enter desired pressure value for each droplet size indicator selected.

- Press OK.

Refer to your spray product catalog for recommended spray tip psi/bar.

FENCE ROW APPLICATOR

To Operate the Fence Row Nozzles

- Press the desired Fence Row Switch - Left or Right (located on the side console) to turn ON. Press switch again to turn OFF.

NOTE: The corresponding Fence Row Switch will illuminate when active.

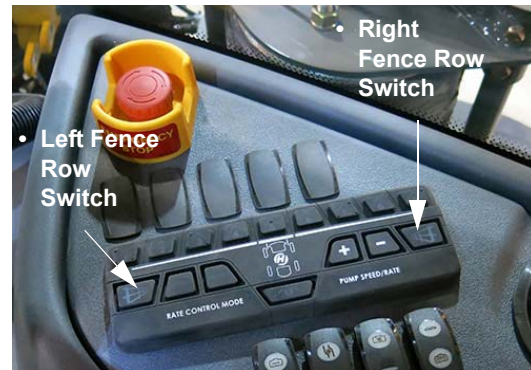

Fence Row Switches - Left and Right (Located on the side console) -Typical View

NOTE: When either Fence Row Switch is activated, you may notice a drop in solution pressure.

To Operate the Rear Nozzles

The Rear Nozzle Switch (located on the side console) controls the two (2) rear nozzles (located behind the tires).

- Press the Rear Nozzle Switch to turn ON. Press switch again to turn OFF.

NOTE: The Rear Nozzle Switch will illuminate when active.



Rear Nozzle Switch (Located on the side console) -Typical View

FILLING YOUR SOLUTION TANK

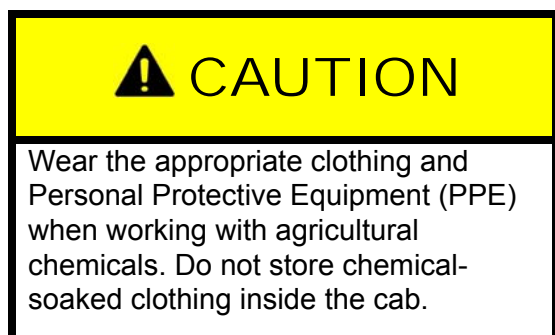

Front Fill

-If Equipped

Filling the Solution Tank

1. Pull the Front Fill Release Lever (located beneath front end of machine) OUT (toward operator) to unlock the Front Fill Assembly.

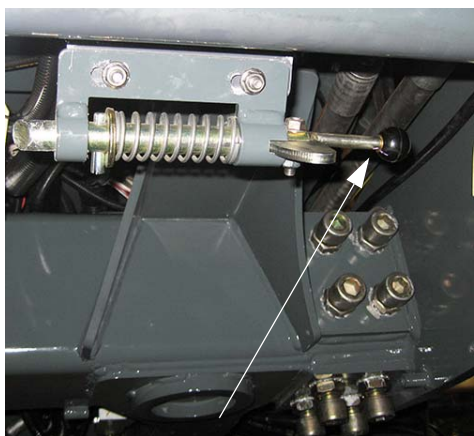

Front Fill Release Lever
(Located beneath front end of machine)
-Typical View

2. Lower the Front Fill Assembly.

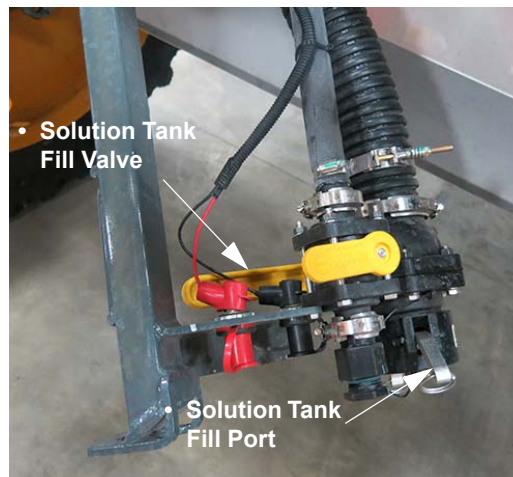

Front Fill Assembly
(Lowered position shown)
-Typical View

3. Remove fill port cap and connect solution supply to the Solution Tank Fill Port.
4. Rotate Solution Tank Fill Valve to the OPEN position and fill tank to desired level.

NOTE: Two power ports (located near the front fill assembly) are provided for chemical pump connection.

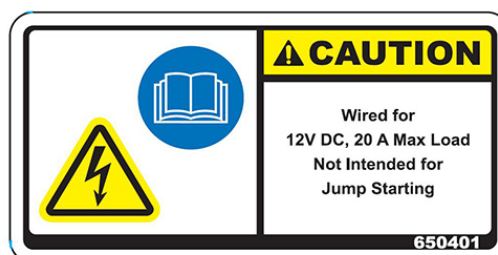



Power Ports
(Located near front fill assembly)
-Typical View

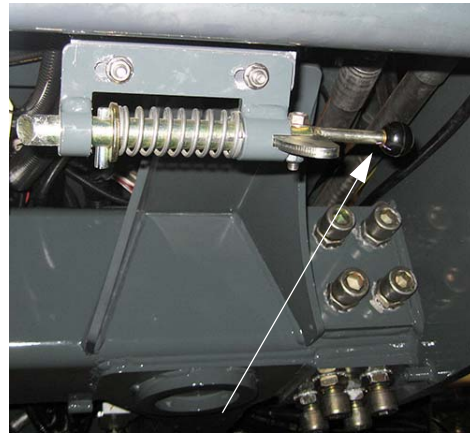

Front Fill Release Lever
(Located beneath front end of machine)
-Typical View

5. **When finished filling the tank**, close the Solution Tank Fill Valve.
6. Remove solution supply from the Solution Tank Fill Port.
7. Reinstall fill port cap.
8. Raise the Front Fill Assembly to stored position, ensuring it “clicks” into locked position.

2. Lower the Front Fill Assembly.

Filling the Rinse Tank

You may fill the Rinse Tank from ground level with an operator-supplied connection.



Front Fill Assembly
(Lowered position shown)
-Typical View



Rinse Tank
-Typical View

1. Pull the Front Fill Release Lever (located beneath front end of machine) OUT (toward operator) to unlock the Front Fill Assembly.

3. Remove fill port cap from the Rinse Tank Fill Port.
4. Connect operator-supplied connection to the Rinse Tank Fill Port.
5. Rotate Rinse Tank Fill Valve to the OPEN position and fill tank to desired level.
6. **When finished filling the tank**, close the Rinse Tank Fill Valve.

7. Remove operator-supplied connection from the Rinse Tank Fill Port.
8. Reinstall the fill port cap.
9. Raise the Front Fill Assembly to the stored position, ensuring it “clicks” into locked position.

Side Fill

-If Equipped

NOTE: Engage parking brake before operating the side fill.

Filling the Solution Tank (Inductor Operation)

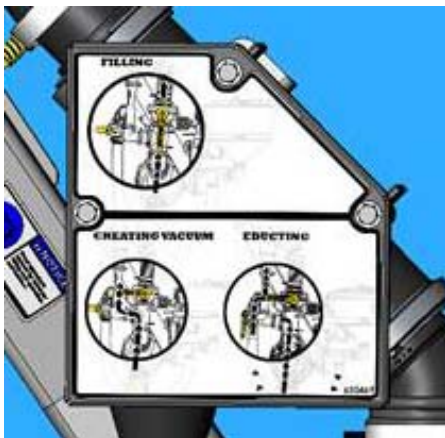

Sidefill Operation Label
(Located on sidefill)
-Typical View

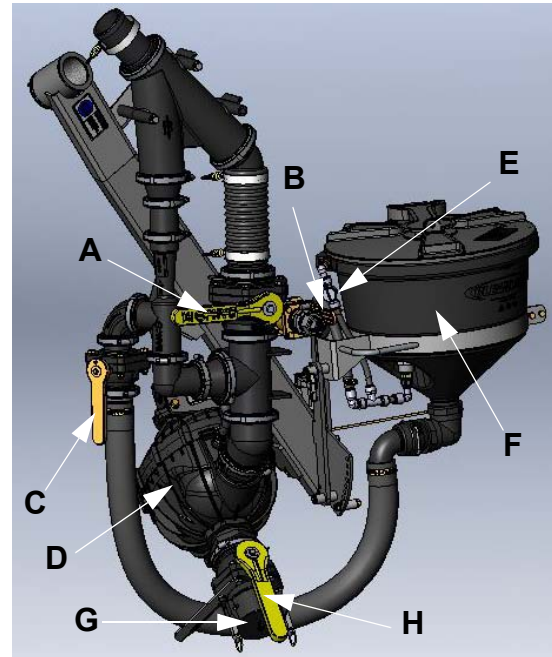

Inductor Assembly
-Typical View

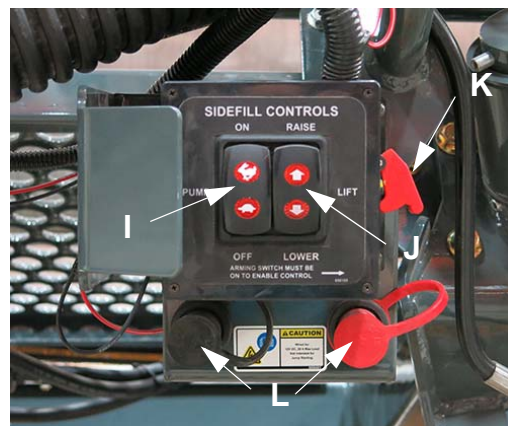

Side Fill Control Panel
-Typical View

Inductor Assembly Components

- (A) - Side Fill Valve
- (B) - Rinse Supply Valve
- (C) - Chemical Inductor Valve
- (D) - Transfer Pump
- (E) - Swirl Valve
- (F) - Chemical Inductor Tank
- (G) - Fill Port
- (H) - Fill Valve
- (I) - Pump Speed Switch
- (J) - Raise/Lower Switch
- (K) - Pump Activation Lever
- (L) - Power Ports

NOTE: Two power ports (located beneath the Side Fill Control Panel) are provided for chemical pump connection.

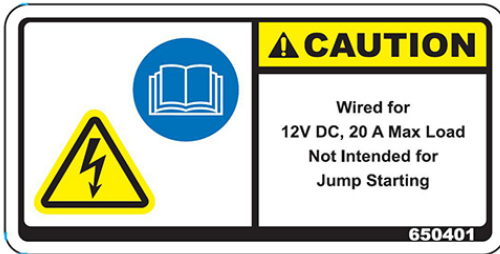

1. Engage the parking brake.
2. Start the engine.
3. Lift the Pump Activation Lever (K) UP.
4. Lower the Inductor Assembly by pressing the Raise/Lower Switch (J) in the DOWN (Lower) position.
5. Press the Pump Speed Switch (I) in the UP (On) position ONCE to activate the Transfer Pump.
6. Press and hold the Pump Speed Switch UP to increase speed or DOWN to decrease speed.

NOTE: Engine speed automatically increases to 1500 RPM at maximum pump speed.

NOTE: Always match pump speed to available supply to avoid pump damage.

NOTE: Whether filling with the Transfer Pump or an offsite pump, ensure the Transfer Pump is running.

7. Press and hold the Pump Speed Switch in the DOWN (Off) position when filling is complete.
8. Push the Pump Activation Lever DOWN.

NOTE: The following procedures are the same for either a sprayer-mounted transfer pump or a nurse tank pump.

Fill Water Only

- Fill Port (G) - *CONNECTED*
- Fill Valve (H) - *OPEN*
- Chemical Inductor Valve (C) - *CLOSED*
- Side Fill Valve (A) - *OPEN*
- Swirl Valve (E) - *CLOSED*

Fill Water/Induct Chemical

- Fill Port (G) - *CONNECTED*

- Fill Valve (H) - *OPEN*
- Side Fill Valve (A) - *CLOSED*
- Chemical Inductor Valve (C) - *OPEN* (after flow is established)

Fill Water/Induct Dry Chemical

- Fill Port (G) - *CONNECTED*
- Fill Valve (H) - *OPEN*
- Side Fill Valve (A) - *CLOSED*
- Swirl Valve (E) - *OPEN*

NOTE: Allow water to fill chemical tank approximately 3 inches (7.6 cm) before adding dry chemical. Add dry chemical with the Swirl Valve (E) OPEN. Open the Chemical Inductor (E) after dry chemical has been added.

Fill Rinse Tank

- Rinse Supply Valve (B) - *OPEN*

Rinse Inductor Tank

- Swirl Valve (E) - *OPEN*

NOTE: Before raising the Inductor Assembly, the Chemical Inductor Tank must be in the LOCKED position.

Rinsing the Side Fill

1. Remove Fill Port cap and set aside.
2. Attach fresh water supply connection to Fill Port.
3. Turn fresh water supply ON.
4. Rotate the Fill Valve (H) in the OPEN position.
5. Rotate the Side Fill Valve (A) in the OPEN position.
6. **When rinsing is complete**, turn fresh water supply OFF.
7. Close the Fill Valve and Side Fill Valve.
8. Remove fresh water supply connection from Fill Port and reinstall cap.

Rear Fill

-If Equipped

Filling the Solution Tank

1. Remove fill port cap and connect solution supply to the Solution Tank Fill Port (located behind rear left-hand wheel).



Rear Fill Assembly
(Located behind rear left-hand wheel)
-Typical View

2. Rotate Solution Tank Fill Valve to the OPEN (counter-clockwise) position and fill tank to desired level.
3. **When finished filling the tank**, close the Solution Tank Fill Valve.
4. Remove solution supply from the Solution Tank Fill Port.
5. Reinstall fill port cap.

Filling the Rinse Tank

1. Remove fill port cap from the Rinse Tank Fill Port.



Rear Fill Assembly
(Located behind rear left-hand wheel)
-Typical View

2. Connect operator-supplied connection to the Rinse Tank Fill Port.

3. Rotate Rinse Tank Fill Valve to the OPEN (counter-clockwise) position and fill tank to desired level.
4. **When finished filling the tank**, close the Rinse Tank Fill Valve.
5. Remove operator-supplied connection from the Rinse Tank Fill Port.
6. Reinstall the fill port cap.

DRAINING YOUR SOLUTION TANK

! DANGER



NEVER ENTER SOLUTION TANK WITH WHOLE BODY.
FAILURE TO COMPLY WILL RESULT IN SERIOUS INJURY OR DEATH.

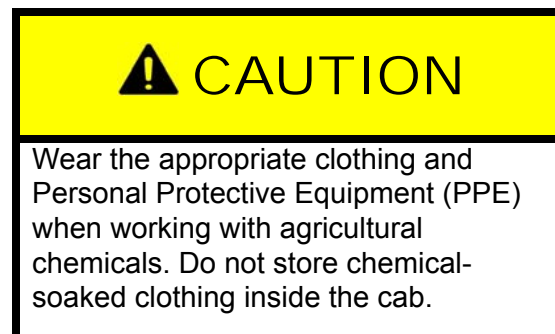

NOTICE

When draining large volumes from the solution tank, it is recommended to pump off with the solution pump through the front quick coupler.

To Drain the Solution Tank

1. Loosen the metal valve clamp and remove Drain Valve Plug (located on the end of the Solution Tank Drain Valve Assembly).

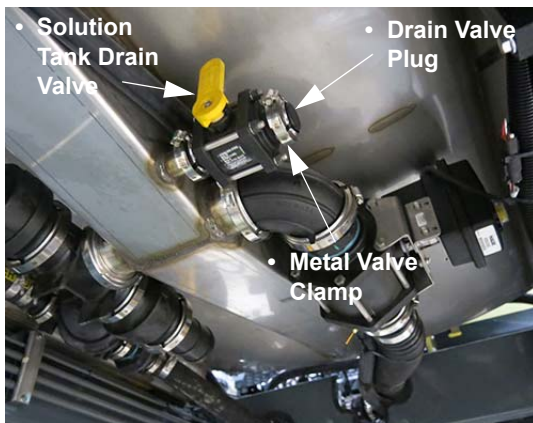

Solution Tank Drain Valve Assembly
(Located beneath the solution tank on underside of machine)
-Typical View

2. Attach an operator-supplied hose to the end of the Solution Tank Drain Valve Assembly (where Drain Valve Plug was previously removed).
3. Turn the Solution Tank Drain Valve in the OPEN (counter-clockwise) position and allow solution to drain into an appropriate container for storage.

NOTE: Always ensure that storage containers and clearly marked with what type of chemical is being stored.

4. **When finished draining the solution tank**, turn the Solution Tank Drain Valve in the CLOSE (clockwise) position.

5. Remove hose from the Solution Tank Drain Valve Assembly.
6. Tighten metal valve clamp.

RINSE SYSTEM

Operate the Rinse System on your machine to flush the spray system (solution tank, booms, nozzles, and solution pump) with fresh water.

NOTE: Ensure the solution tank is completely empty before activating the Rinse System.

NOTICE

Select a safe area to rinse the spray system and clean the sprayer where chemicals will not drift off to contaminate people, animals, vegetation, or water supply.

NOTICE

Never attempt to operate the Rinse System without fresh water in the rinse tank. Failure to comply will result in equipment damage and will void the warranty.

NOTICE

Fill rinse tank with fresh water only.

Refer to the chemical manufacturer's information for types of cleaning solution combinations (water, cleaning agents, etc.)

Step 1 - Rinsing the Solution Tank

1. Press the Main Tank Valve Switch (located on the side console) in the DOWN (Close) position.



Main Tank Valve Switch
 (Located on the side console)
 -Typical View

2. Press the Rinse Switch (located on the side console) in the DOWN position to rinse the solution tank.



Rinse Switch
 (Located on the side console)
 -Typical View

NOTE: A Rinse Mode Indicator is located on the Machine Display Home Page - Field Mode and will display current rinse mode status (TANK or BOOM).



Rinse Mode Indicator
 (Located on the Machine Display
 Home Page - Field Mode)

3. Press the Agitation Valve Switch (located on the side console) in the UP (Open) position.



Agitation Valve Switch
 (Located on the side console)
 -Typical View

4. Press the Solution Pump Switch (located on the side console) in the UP (On) position.



Solution Pump Switch
(Located on the side console)
-Typical View

5. Press the Manual (MAN) Rate Control Switch (located on the side console).



Manual "MAN" Rate Control Switch
(Located on the side console)
-Typical View

6. Press the "+" Pump Speed/Rate Switch (located on the side console) to increase solution pressure to desired PSI (bar).



"+" Pump Speed/Rate Switch
(Located on the side console)
-Typical View

7. When finished rinsing the solution tank, press the Rinse Switch to the OFF (mid) position.

Step 2 - Spray Diluted Water from Tank

1. Press the Agitation Valve Switch (located on the side console) in the DOWN (Close) position.
2. Press the Main Tank Valve Switch (located on the side console) in the UP (Open) position.
3. Press the Boom Solution Valve Switches (located on the side console) in the ON position.

NOTE: Each Boom Solution Valve Switch is equipped with an indicator light and will illuminate when the corresponding Boom Solution Valve is OFF.



Boom Solution Valve Switches
(Located on the side console)
-Typical View



Main Tank Valve Switch
(Located on the side console)
-Typical View

4. Press the Master Spray Switch (located on the Hydrostatic Drive Control Handle) in the ON position.
5. Continue spraying until all diluted water is removed from tank.

2. Press the Rinse Switch (located on the side console) in the UP position to rinse the boom and nozzles.

NOTICE

Do not allow the solution pump to run dry for a prolonged period of time. Failure to comply may result in pump damage.

Step 3 - Rinsing the Boom and Nozzles

1. Press the Main Tank Valve Switch (located on the side console) in the DOWN (Close) position.



Rinse Switch
(Located on the side console)
-Typical View

NOTE: A Rinse Mode Indicator is located on the Machine Display Home Page - Field Mode and will display current rinse mode status (TANK or BOOM).

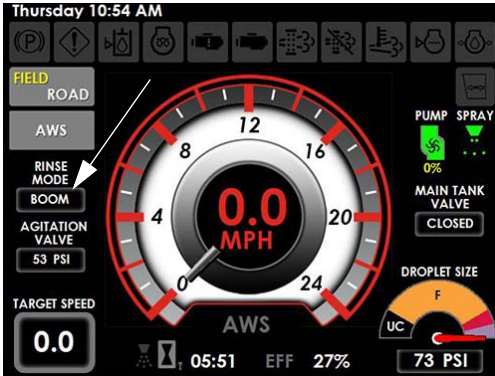

Rinse Mode Indicator
(Located on the Machine Display
Home Page - Field Mode)

3. Press the Manual (MAN) Rate Control Switch (located on the side console).



Manual “MAN” Rate Control Switch
(Located on the side console)
-Typical View

4. Press the “+” Pump Speed/Rate Switch (located on the side console) to increase the solution pressure to desired PSI (bar).



“+” Pump Speed/Rate Switch
(Located on the side console)
-Typical View

5. Press the Master Spray Switch (located on the Hydrostatic Drive Control Handle) in the OFF position.
6. Press the Solution Pump Switch (located on the side console) in the DOWN (Off) position.
7. When rinsing is complete, press the Rinse Switch to the OFF (mid) position.

FOAM MARKER SYSTEM

- If Equipped

! CAUTION

Maximum foam regulator pressure is 20 PSI (1.4 bar). Use of higher pressure may cause personal injury and system damage and will void the warranty.

Foam Marker Operation

1. Open the Foam Marker Valve (located near rear of rinse tank).
 - Turn valve “clockwise” to open.
 - Turn valve “counter-clockwise” to close.

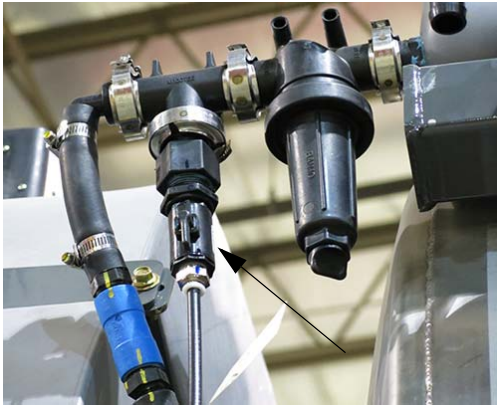

Foam Marker Valve
(Located near rear of rinse tank)
-Typical View

2. Locate the Foam Marker Switch (located on the side console).
- Press Foam Marker Switch in the UP position if foam application is desired from the Left Foam Drop.
 - Press Foam Marker Switch in the DOWN position if foam application is desired from the Right Foam Drop.
 - Return Foam Marker Switch to the MID (Off) position if no foam is desired.



Foam Marker Switch
(Located on the side console)
-Typical View

3. Observe system pressure indicated on the Foam Pressure Gauge (located on the side of the Foam Marker Tank, mounted on the right-hand side of machine).



Foam Pressure Gauge
(Located on the side of the
Foam Marker Tank, mounted on
the right-hand side of machine)
-Typical View

Pressure Adjustment

- Turn Foam Pressure Dial (located on the side of the Foam Marker Tank) to adjust air pressure in the tank. Turn dial “clockwise” to INCREASE pressure. Turn dial “counter-clockwise” to DECREASE pressure.



Foam Pressure Dial
(Located on the side of
the Foam Marker Tank)
-Typical View

Setting the Foam Marker

(Foam Frequency and Concentration)

- Turn Foam Frequency Dial (located on the side of the Foam Marker Tank) to adjust the foam frequency. Turn dial “clockwise” to INCREASE frequency. Turn dial “counter-clockwise” to DECREASE frequency.
- Turn Foam Concentration Dial (located on the side of the Foam Marker Tank) to adjust the foam concentration level. Turn dial “clockwise” to INCREASE concentration. Turn dial “counter-clockwise” to DECREASE concentration.

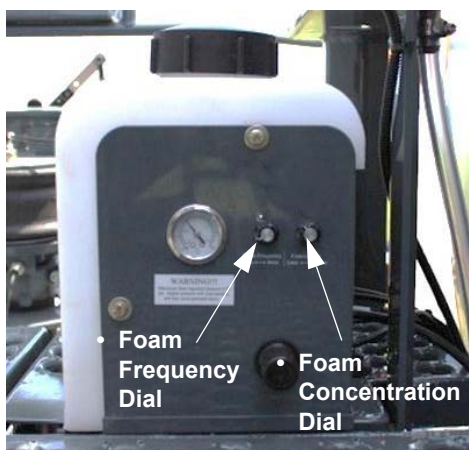

Foam Frequency and
Concentration Dials
(Located on the side of
the Foam Marker Tank)
-Typical View

Foam Drop Configurations

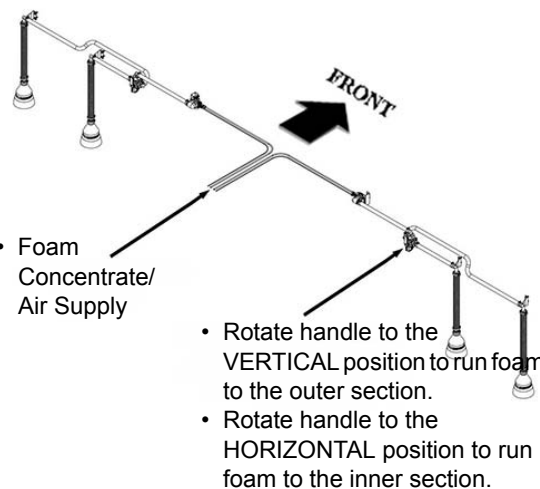

- Foam Concentrate/ Air Supply
- Rotate handle to the VERTICAL position to run foam to the outer section.
- Rotate handle to the HORIZONTAL position to run foam to the inner section.

-Typical View

APPLICATION

It is important to apply chemicals as recommended by the manufacturer. In order to do so, the spray system console must be properly calibrated.

NOTE: Refer to the spray system console manufacturer’s operation manual for calibration instructions.

Determine the speed in which the sprayer will travel when applying chemicals. To select the best speed, consider the lay of the land, condition of the soil, type of crop, height of crop, etc.

Remember that the performance of the nozzles (spray tips) and spray system are dependent on the performance of the operator. If the spray system is operated within set parameters of the nozzle type and spray system console, you will see greater success with your application. Operating the machine one or two miles per hour (1.6 to 3.2 km/h) faster or slower than intended can greatly change the pressure and droplet size.

Select nozzle spacing (distance between each nozzle on the spray boom) that is best suited for the intended spray application. For

recommendation in determining nozzle spacing and height of the boom, visit www.teejet.com for further information.

There are various types and sizes of nozzles. Select and install the appropriate nozzle best suited for the intended spray application. The type of nozzle will depend on the product being applied and the type of crop that it is being used on. The size of nozzles selected will be based on the speed in which the machine will travel, nozzle spacing, desired droplet size, and the number of gallons per acre (GPA)/liters per hectare (l/ha) that will be applied.

Nozzle Selection

There are several things to consider when selecting the correct nozzle type for the intended spray application. Whatever your personal preference is, ensure that the nozzle complies with the chemical manufacturer's standards for spray control and also any environmental standards for your region.

NOTE: Certain regions may have restrictions on drift control.

Once you have selected the type of nozzle, you must choose the size of the nozzle. There are three main things to consider when choosing a nozzle size:

1. Recommendation of GPA (l/ha).
2. The speed in which you intend to travel when applying chemical and nozzle spacing (distance between nozzles).

3. Spray Tip size (refer to the following example on how to select a proper tip size).

The following Application Rate Chart provides tabulations based on spraying water. When spraying liquids other than water, you will need to use a conversion factor to configure the appropriate application rates.

Example of how to choose the proper nozzle:

Joe is spraying 28% nitrogen. The chemical manufacturer recommends that the chemical be applied at 20 gallons per acre (GPA)/187 liters per hectare (l/ha). Joe knows that he can run his sprayer at 10 mph (16 km/h) across the field. He has 20-inch (50 cm) nozzle spacing on his booms. Joe has narrowed his tip search to flat spray tips.

Use the following conversion formula:

- **20 GPA (187 l/ha) (liquid other than water) x 1.13 (conversion factor) = 22.6 GPA (211.3 l/ha) (water).**

Joe determined that he needs an application rate of 22.6 GPA (211.3 l/ha) to select the correct nozzle to apply 28% nitrogen at 20 GPA (187 l/ha).

To determine which nozzle is better for his intended use, Joe needs to figure out the gallons per minute (GPM)/liters per minute (l/min) each nozzle needs to spray.

$$\text{GPM} = \frac{\text{GPA} \times \text{MPH} \times \text{Nozzle Spacing}}{5940 \text{ (Constant)}}$$

$$\text{l/min} = \frac{\text{l/ha} \times \text{km/h} \times \text{Nozzle Spacing}}{60,000}$$

Examples:

$$\text{GPM} = \frac{22.6 \times 10 \times 20}{5940} = \frac{4520}{5940} = \mathbf{0.76 \text{ GPM}} \text{ (per nozzle)}$$

$$\text{l/min} = \frac{211.3 \times 16 \times 50}{60,000} = \frac{169040}{60,000} = \mathbf{2.82 \text{ l/min}}$$

English to Metric Conversion
<ul style="list-style-type: none"> • Gallons per Acre (GPA) x 9.354 = Liters per Hectare (l/ha) • Gallons per Minute (GPM) x 3.785 = Liters per Minute (l/min)
Metric to English Conversion
<ul style="list-style-type: none"> • Liters per Hectare (l/ha) x .1069 = Gallons per Acre (GPA) • Liters per Minute (l/min) x .26 = Gallons per Minute (GPM)

NOTE: Always double check your application rates. The following tabulations are based on spraying water at 70° F./21° C.



Standard Application Rate Chart												
				Gallons per Acre (GPA) - 15" Nozzle Spacing								
Tip Cap.	Liquid Pressure (PSI)	Cap. 1 Nozzle (GPM)	Cap. 1 Nozzle (Oz./Min.)	4 mph	6 mph	8 mph	10 mph	12 mph	14 mph	16 mph	18 mph	20 mph
01	15	0.061	7.8	6.0	4.0	3.0	2.4	2.0	1.7	1.5	1.3	1.2
	20	0.071	9.1	7.0	4.7	3.5	2.8	2.3	2.0	1.8	1.6	1.4
	30	0.087	11	8.6	5.7	4.3	3.4	2.9	2.5	2.2	1.9	1.7
	40	0.10	13	9.9	6.6	5.0	4.0	3.3	2.8	2.5	2.2	2.0
	50	0.11	14	10.9	7.3	5.4	4.4	3.6	3.1	2.7	2.4	2.2
	60	0.12	15	11.9	7.9	5.9	4.8	4.0	3.4	3.0	2.6	2.4
	75	0.14	18	13.9	9.2	6.9	5.5	4.6	4.0	3.5	3.1	2.8
	90	0.15	19	14.9	9.9	7.4	5.9	5.0	4.2	3.7	3.3	3.0
015	15	0.092	12	9.1	6.1	4.6	3.6	3.0	2.6	2.3	2.0	1.8
	20	0.11	14	10.9	7.3	5.4	4.4	3.6	3.1	2.7	2.4	2.2
	30	0.13	17	12.9	8.6	6.4	5.1	4.3	3.7	3.2	2.9	2.6
	40	0.15	19	14.9	9.9	7.4	5.9	5.0	4.2	3.7	3.3	3.0
	50	0.17	22	16.8	11.2	8.4	6.7	5.6	4.8	4.2	3.7	3.4
	60	0.18	23	17.8	11.9	8.9	7.1	5.9	5.1	4.5	4.0	3.6
	75	0.21	27	21	13.9	10.4	8.3	6.9	5.9	5.2	4.6	4.2
	90	0.23	29	23	15.2	11.4	9.1	7.6	6.5	5.7	5.1	4.6
02	15	0.12	15	11.9	7.9	5.9	4.8	4.0	3.4	3.0	2.6	2.4
	20	0.14	18	13.9	9.2	6.9	5.5	4.6	4.0	3.5	3.1	2.8
	30	0.17	22	16.8	11.2	8.4	6.7	5.6	4.8	4.2	3.7	3.4
	40	0.20	26	19.8	13.2	9.9	7.9	6.6	5.7	5.0	4.4	4.0
	50	0.22	28	22	14.5	10.9	8.7	7.3	6.2	5.4	4.8	4.4
	60	0.24	31	24	15.8	11.9	9.5	7.9	6.8	5.9	5.3	4.8
	75	0.27	35	27	17.8	13.4	10.7	8.9	7.6	6.7	5.9	5.3
	90	0.30	38	30	19.8	14.9	11.9	9.9	8.5	7.4	6.6	5.9
025	15	0.15	19	14.9	9.9	7.4	5.9	5.0	4.2	3.7	3.3	3.0
	20	0.18	23	17.8	11.9	8.9	7.1	5.9	5.1	4.5	4.0	3.6
	30	0.22	28	22	14.5	10.9	8.7	7.3	6.2	5.4	4.8	4.4
	40	0.25	32	25	16.5	12.4	9.9	8.3	7.1	6.2	5.5	5.0
	50	0.28	36	28	18.5	13.9	11.1	9.2	7.9	6.9	6.2	5.5
	60	0.31	40	31	20	15.3	12.3	10.2	8.8	7.7	6.8	6.1
	75	0.34	44	34	22	16.8	13.5	11.2	9.6	8.4	7.5	6.7
	90	0.38	49	38	25	18.8	15.0	12.5	10.7	9.4	8.4	7.5



SECTION 7 -
SPRAY SYSTEMS

03	15	0.18	23	17.8	11.9	8.9	7.1	5.9	5.1	4.5	4.0	3.6
	20	0.21	27	21	13.9	10.4	8.3	6.9	5.9	5.2	4.6	4.2
	30	0.26	33	26	17.2	12.9	10.3	8.6	7.4	6.4	5.7	5.1
	40	0.30	38	30	19.8	14.9	11.9	9.9	8.5	7.4	6.6	5.9
	50	0.34	44	34	22	16.8	13.5	11.2	9.6	8.4	7.5	6.7
	60	0.37	47	37	24	18.3	14.7	12.2	10.5	9.2	8.1	7.3
	75	0.41	52	41	27	20	16.2	13.5	11.6	10.1	9.0	8.1
	90	0.45	58	45	30	22	17.8	14.9	12.7	11.1	9.9	8.9
04	15	0.24	31	24	15.8	11.9	9.5	7.9	6.8	5.9	5.3	4.8
	20	0.28	36	28	18.5	13.9	11.1	9.2	7.9	6.9	6.2	5.5
	30	0.35	45	35	23	17.3	13.9	11.6	9.9	8.7	7.7	6.9
	40	0.40	51	40	26	19.8	15.8	13.2	11.3	9.9	8.8	7.9
	50	0.45	58	45	30	22	17.8	14.9	12.7	11.1	9.9	8.9
	60	0.49	63	49	32	24	19.4	16.2	13.9	12.1	10.8	9.7
	75	0.55	70	54	36	27	22	18.2	15.6	13.6	12.1	10.9
	90	0.60	77	59	40	30	24	19.8	17.0	14.9	13.2	11.9
05	15	0.31	40	31	20	15.3	12.3	10.2	8.8	7.7	6.8	6.1
	20	0.35	45	35	23	17.3	13.9	11.6	9.9	8.7	7.7	6.9
	30	0.43	55	43	28	21	17.0	14.2	12.2	10.6	9.5	8.5
	40	0.50	64	50	33	25	19.8	16.5	14.1	12.4	11.0	9.9
	50	0.56	72	55	37	28	22	18.5	15.8	13.9	12.3	11.1
	60	0.61	78	60	40	30	24	20	17.3	15.1	13.4	12.1
	75	0.68	87	67	45	34	27	22	19.2	16.8	15.0	13.5
	90	0.75	96	74	50	37	30	25	21	18.6	16.5	14.9
06	15	0.37	47	37	24	18.3	14.7	12.2	10.5	9.2	8.1	7.3
	20	0.42	54	42	28	21	16.6	13.9	11.9	10.4	9.2	8.3
	30	0.52	67	51	34	26	21	17.2	14.7	12.9	11.4	10.3
	40	0.60	77	59	40	30	24	19.8	17.0	14.9	13.2	11.9
	50	0.67	86	66	44	33	27	22	19.0	16.6	14.7	13.3
	60	0.73	93	72	48	36	29	24	21	18.1	16.1	14.5
	75	0.82	105	81	54	41	32	27	23	20	18.0	16.2
	90	0.90	115	89	59	45	36	30	25	22	19.8	17.8
08	15	0.49	63	49	32	24	19.4	16.2	13.9	12.1	10.8	9.7
	20	0.57	73	56	38	28	23	18.8	16.1	14.1	12.5	11.3
	30	0.69	88	68	46	34	27	23	19.5	17.1	15.2	13.7
	40	0.80	102	79	53	40	32	26	23	19.8	17.6	15.8
	50	0.89	114	88	59	44	35	29	25	22	19.6	17.6
	60	0.98	125	97	65	49	39	32	28	24	22	19.4
	75	1.10	141	109	73	54	44	36	31	27	24	22
	90	1.20	154	119	79	59	48	40	34	30	26	24
10	15	0.61	78	60	40	30	24	20	17.3	15.1	13.4	12.1
	20	0.71	91	70	47	35	28	23	20	17.6	15.6	14.1
	30	0.87	111	86	57	43	34	29	25	22	19.1	17.2
	40	1.00	128	99	66	50	40	33	28	25	22	19.8
	50	1.12	143	111	74	55	44	37	32	28	25	22
	60	1.22	156	121	81	60	48	40	35	30	27	24
	75	1.37	175	136	90	68	54	45	39	34	30	27
	90	1.50	192	149	99	74	59	50	42	37	33	30
15	15	0.92	118	91	61	46	36	30	26	23	20	18.2
	20	1.06	136	105	70	52	42	35	30	26	23	21
	30	1.30	166	129	86	64	51	43	37	32	29	26
	40	1.50	192	149	99	74	59	50	42	37	33	30
	50	1.68	215	166	111	83	67	55	48	42	37	33
	60	1.84	236	182	121	91	73	61	52	46	40	36
	75	2.05	262	203	135	101	81	68	58	51	45	41
	90	2.25	288	223	149	111	89	74	64	56	50	45

SECTION 7 -
 SPRAY SYSTEMS



20	15	1.22	156	121	81	60	48	40	35	30	27	24
	20	1.41	180	140	93	70	56	47	40	35	31	28
	30	1.73	221	171	114	86	69	57	49	43	38	34
	40	2.00	256	198	132	99	79	66	57	50	44	40
	50	2.24	287	222	148	111	89	74	63	55	49	44
	60	2.45	314	243	162	121	97	81	69	61	54	49
	75	2.74	351	271	181	136	109	90	78	68	60	54
	90	3.00	384	297	198	149	119	99	85	74	66	59

Metric Application Rate Chart													
			Liters per Hectare (l/ha) - 40 cm Nozzle Spacing										
Tip Cap.	Liquid Press. (Bar)	Cap. 1 Nozzle (l/min)	4 km/h	6 km/h	8 km/h	10 km/h	12 km/h	14 km/h	16 km/h	18 km/h	20 km/h	25 km/h	30 km/h
01	1.0	0.23	86.3	57.5	43.1	34.5	28.8	24.6	21.6	19.2	17.3	13.8	11.5
	1.5	0.28	105	70.0	52.5	42.0	35.0	30.0	26.3	23.3	21.0	16.8	14.0
	2.0	0.32	120	80.0	60.0	48.0	40.0	34.3	30.0	26.7	24.0	19.2	16.0
	3.0	0.39	146	97.5	73.1	58.5	48.8	41.8	36.6	32.5	29.3	23.4	19.5
	4.0	0.45	169	113	84.4	67.5	56.3	48.2	42.2	37.5	33.8	27.0	22.5
	5.0	0.50	188	125	93.8	75.0	62.5	53.6	46.9	41.7	37.5	30.0	25.0
	6.0	0.55	206	138	103	82.5	68.8	58.9	51.6	45.8	41.3	33.0	27.5
	7.0	0.60	225	150	113	90.0	75.0	64.3	56.3	50.0	45.0	36.0	30.0
015	1.0	0.34	128	85	63.8	51.0	42.5	36.4	31.9	28.3	25.5	20.4	17.0
	1.5	0.42	158	105	78.8	63.0	52.5	45.0	39.4	35.0	31.5	25.2	21.0
	2.0	0.48	180	120	90.0	72.0	60.0	51.4	45.0	40.0	36.0	28.8	24.0
	3.0	0.59	221	148	111	88.5	73.8	63.2	55.3	49.2	44.3	35.4	29.5
	4.0	0.68	255	170	128	102	85.0	72.9	63.8	56.7	51.0	40.8	34.0
	5.0	0.76	285	190	143	114	95.0	81.4	71.3	63.3	57.0	45.6	38.0
	6.0	0.83	311	208	156	125	104	88.9	77.8	69.2	62.3	49.8	41.5
	7.0	0.90	338	225	169	135	113	96.4	84.4	75.0	67.5	54.0	45.0
02	1.0	0.46	173	115	86.3	69.0	57.5	49.3	43.1	38.3	34.5	27.6	23.0
	1.5	0.56	210	140	105	84.0	70.0	60.0	52.5	46.7	42.0	33.6	38.0
	2.0	0.65	244	163	122	97.5	81.3	69.6	60.9	54.2	48.8	39.0	32.5
	3.0	0.79	296	198	148	119	98.8	84.6	74.1	65.8	59.3	47.4	39.5
	4.0	0.91	341	228	171	137	114	97.5	85.3	75.8	68.3	54.6	45.5
	5.0	1.02	383	255	191	153	128	109	95.6	85.0	76.5	61.2	51.0
	6.0	1.12	420	280	210	168	140	120	105	93.3	84.0	67.2	56.0
	7.0	1.21	454	303	227	182	151	130	113	101	90.8	72.6	60.5
025	1.0	0.57	214	143	107	85.5	71.3	61.1	53.4	47.5	42.8	34.2	28.5
	1.5	0.70	263	175	131	105	87.5	75.0	65.6	58.3	52.5	42.0	35.0
	2.0	0.81	304	203	152	122	101	86.8	75.9	67.5	60.8	48.6	40.5
	3.0	0.99	371	248	186	149	124	106	92.8	82.5	74.3	59.4	49.5
	4.0	1.14	428	285	214	171	143	122	107	95.0	85.5	68.4	57.0
	5.0	1.28	480	320	240	192	160	137	120	107	96.0	76.8	64.0
	6.0	1.40	525	350	263	210	175	150	131	117	105	84.0	70.0
	7.0	1.51	566	378	283	227	189	162	142	126	113	90.6	75.5

SECTION 7 -
 SPRAY SYSTEMS



03	1.0	0.68	255	170	128	102	85	72.9	63.8	56.7	51.0	40.8	34.0
	1.5	0.83	311	208	156	125	104	88.9	77.8	69.2	62.3	49.8	41.5
	2.0	0.96	360	240	180	144	120	103	90.0	80.0	72.0	57.6	48.0
	3.0	1.18	443	295	221	177	148	126	111	98.3	88.5	70.8	59.0
	4.0	1.36	510	340	255	204	170	146	128	113	102	81.6	68.0
	5.0	1.52	570	380	285	228	190	163	143	127	114	91.2	76.0
	6.0	1.67	626	418	313	251	209	179	157	139	125	100	83.5
	7.0	1.80	675	450	338	270	225	193	169	150	135	108	90.0
04	1.0	0.91	341	228	171	137	114	97.5	85.3	75.8	68.3	54.6	45.5
	1.5	1.12	420	280	210	168	140	120	105	93.3	84.0	67.2	56.0
	2.0	1.29	484	323	242	194	161	138	121	108	96.8	77.4	64.5
	3.0	1.58	593	395	296	237	198	169	148	132	119	94.8	79.0
	4.0	1.82	683	455	341	273	228	195	171	152	137	109	91.0
	5.0	2.04	765	510	383	306	255	219	191	170	153	122	102
	6.0	2.23	836	558	418	335	279	239	209	186	167	134	112
	7.0	2.41	904	603	452	362	301	258	226	201	181	145	121
05	1.0	1.14	428	285	214	171	143	122	107	95	85.5	68.4	57.0
	1.5	1.39	521	348	261	209	174	149	130	116	104	83.4	69.5
	2.0	1.61	604	403	302	242	201	173	151	134	121	96.6	80.5
	3.0	1.97	739	493	369	296	246	211	185	164	148	118	98.5
	4.0	2.27	851	568	426	341	284	243	213	189	170	136	114
	5.0	2.54	953	635	476	381	318	272	238	212	191	152	127
	6.0	2.79	1046	698	523	419	349	299	262	233	209	167	140
	7.0	3.01	1129	753	564	452	376	323	282	251	226	181	151
06	1.0	1.37	514	343	257	206	171	147	128	114	103	82.2	68.5
	1.5	1.68	630	420	315	252	210	180	158	140	126	101	84.0
	2.0	1.94	728	485	364	291	243	208	182	162	146	116	97.0
	3.0	2.37	889	593	444	356	296	254	222	198	178	142	119
	4.0	2.74	1028	685	514	411	343	294	257	228	206	164	137
	5.0	3.06	1148	765	574	459	383	328	287	255	230	184	153
	6.0	3.35	1256	838	628	503	419	359	314	279	251	201	168
	7.0	3.62	1358	905	679	543	453	388	339	302	272	217	181
08	1.0	1.82	683	455	341	273	228	195	171	152	137	109	91
	1.5	2.23	836	558	418	335	279	239	209	186	167	134	112
	2.0	2.58	968	645	484	387	323	276	242	215	194	155	129
	3.0	3.16	1185	790	593	474	395	339	296	263	237	190	158
	4.0	3.65	1369	913	684	548	456	391	342	304	274	219	183
	5.0	4.08	1530	1020	765	612	510	437	383	340	306	245	204
	6.0	4.47	1676	1118	838	671	559	479	419	373	335	268	224
	7.0	4.83	1811	1208	906	725	604	518	453	403	362	290	242
10	1.0	2.28	855	570	428	342	285	244	214	190	171	137	114
	1.5	2.79	1046	698	523	419	349	299	262	233	209	167	140
	2.0	3.23	1211	808	606	485	404	346	303	269	242	194	162
	3.0	3.95	1481	988	741	593	494	423	370	329	296	237	198
	4.0	4.56	1710	1140	855	684	570	489	428	380	342	274	228
	5.0	5.10	1913	1275	956	765	638	546	478	425	383	306	255
	6.0	5.59	2096	1398	1048	839	699	599	524	466	419	335	280
	7.0	6.03	2261	1508	1131	905	754	646	565	503	452	362	302
15	1.0	3.42	1283	855	641	513	428	366	321	285	257	205	171
	1.5	4.19	1571	1048	786	629	524	449	393	349	314	251	210
	2.0	4.83	1811	1208	906	725	604	518	453	403	362	290	242
	3.0	5.92	2220	1480	1110	888	740	634	555	493	444	355	296
	4.0	6.84	2565	1710	1283	1026	855	733	641	570	513	410	342
	5.0	7.64	2865	1910	1433	1146	955	819	716	637	573	458	382
	6.0	8.37	3139	2093	1569	1256	1046	897	785	698	628	502	419
	7.0	9.04	3390	2260	1695	1356	1130	969	848	753	678	542	452

20	1.0	4.56	1710	1140	855	684	570	489	428	380	342	274	228
	1.5	5.58	2093	1395	1046	837	698	598	523	465	419	335	279
	2.0	6.44	2415	1610	1208	966	805	690	604	537	483	386	322
	3.0	7.89	2959	1973	1479	1184	986	845	740	658	592	473	395
	4.0	9.11	3416	2278	1708	1367	1139	976	854	759	683	547	456
	5.0	10.19	3821	2548	1911	1529	1274	1092	955	849	764	611	510
	6.0	11.16	4185	2790	2093	1674	1395	1196	1046	930	837	670	558
	7.0	12.05	4519	3013	2259	1808	1506	1291	1130	1004	904	723	603

NOTE: The previous tabulations are based on 15-inch/40 cm nozzle spacing. Visit www.teejet.com for tabulations if choosing spacing other than 15"/40 cm.

Verifying Calibration



To test your system, fill the solution tank with clean water. **Do not add chemicals until calibration is complete.**

1. Apply the parking brake.
2. Start the engine.
3. Throttle the engine to operating speed.
4. Turn the spray system console ON.
5. Change the drive state of the machine to Field Mode on the Machine Display - Home Page.
6. Press the Main Tank Valve Switch (located on the side console) in the UP (Open) position.
7. Press the Master Spray Switch (located on the Hydrostatic Drive Control Handle) in the ON position.
8. Press all Boom Solution Valve Switches (located on the side console) in the ON position.
9. Press the Manual (“MAN”) Rate Control Switch (located on the side console).
10. Press the Pump Speed/Rate Switches (located on the side console) in the “+” position to increase flow.
11. Ensure there are no leaks and that all nozzles are spraying a desirable pattern.

12. Continue spraying in the stationary position for at least 10 minutes for proper warm-up of the sprayer and system.

Once the sprayer has had an adequate warm-up period, you will need to perform a “self test” to simulate speed (although the machine will remain stationary).

NOTE: The following “self-test” steps require measuring flow at given pressure.

- Collect one nozzle’s spray for one (1) minute in an adequately sized and marked container.
 - Verify that the collection equals or is close to the GPM (l/min) for the nozzle, pressure, speed, GPA (l/ha), and spacing that you are using.
- Also to ensure accuracy, you will need to verify the flow meter. To do so:
- Collect one nozzle’s spray for one (1) minute and multiply it by the number of nozzles on the boom. This should equal the amount measured through the flow meter.

Calculating Spray Width

The spray section widths will need to be entered into the spray system console during initial set-up. No matter what the length of the boom is or how many spray sections it has, the formula for calculating section widths are the same.

$$\text{Number of Nozzles} \times \text{Nozzle Spacing} = \text{Spray Section Width}$$

Example:

Section 2 of a 120-ft. boom with 15-inch (38 cm) nozzle spacing (10 spray nozzles).

**10 Nozzles x 15 (Nozzle Spacing)
= 150" (Section Width)**

**10 Nozzles x 38 (Nozzle Spacing)
= 380 cm (Section Width)**

Further Information

Refer to the spray system console manufacturer's operation manual for complete operating and calibrating instructions, troubleshooting tips, and safety precautions.

SECTION 8 – DETASSELING SYSTEMS

DETASSELING SYSTEM COMPONENTS

The Detasseling System is a constantly monitored and continuously adjusted system. The cab-mounted control system receives data from the photo light sensors to determine detasseling height.

The following information in this section explains the detasseling components and their operation. Read the following section entirely before operating the Detasseling System.

NOTICE

Attachment maintenance and repair, including clearing blockages/unplugging detasseler components should be performed by qualified service personnel only.

- (A) - Detasseler Combo Attachment
- (B) - Cutter Heads
- (C) - LS System 12™/Depth Command
- (D) - Quad Pullers
- (E) - LS Photo Light Sensor
- (F) - Detasseling Control Panel
- (G) - Tasselrol®/LS System 12 Control Panel
- (H) - Main Control Switch
- (I) - All-Up/Down Switches

A

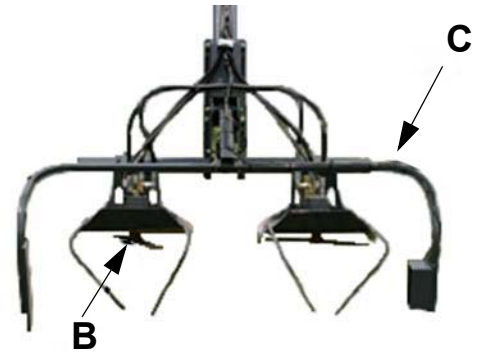

D



E



F





Cutter Head Assembly

CAUTION



SEVERING OF FINGERS OR HAND.
DO NOT PLACE FINGERS OR
HAND NEAR A MOVING CUTTER BLADE,
ATTEMPT TO STOP A MOVING CUTTER
BLADE, OR PERFORM MAINTENANCE
NEAR A MOVING CUTTER BLADE.

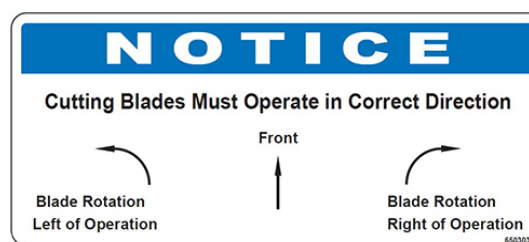

NOTE: Refer to your *Parts Manual* for
specific hardware used.

1. Install two (2) Cutter Heads on each lift head tube, as shown.

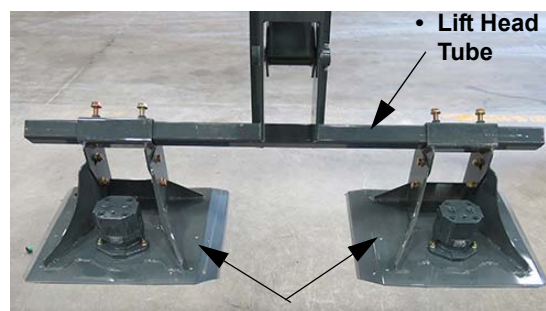

Cutter Heads
-Typical View

2. Ensure each Cutter Head measures 16” (40.6 cm) from the outside of the mount head to the outside of the cutter head mounting tube, making adjustments as necessary.

NOTE: Distance may vary depending on planting pattern.



- Measure 16” (40.6 cm) from the outside of the mount head to the outside of the cutter head mounting tube

3. Ensure each Cutter Head measures 30” (76.2 cm) from center of each cutter head motor.

NOTE: Distance may vary depending on planting pattern.

NOTE: Repeat process, measuring across each lift mount.



- Measure 30” (76.2 cm) from center of each cutter head motor



- Measure 30” (76.2 cm) from center of each cutter head motor, across each lift mount

4. Using a 3/4” socket, tighten each Cutter Head Bolt (two on each Cutter Head Mounting Tube).



Cutter Head Bolts
(Located on each
Cutter Head Mounting Tube)
-Typical View

5. Install two Stalk Guides on each Cutter Head, positioned as shown.



- Install eight (8) Stalk Guide Bolts (4 each side) through bottom of each Cutter Head/Stalk Guide.
- Install eight (8) Stalk Guide Nuts (4 each side) onto the bolts and tighten with a 7/16” socket.



Stalk Guide Installation
-Typical View

6. Apply anti-seize lubricant to inside of Cutter Blade Adapter Plug.

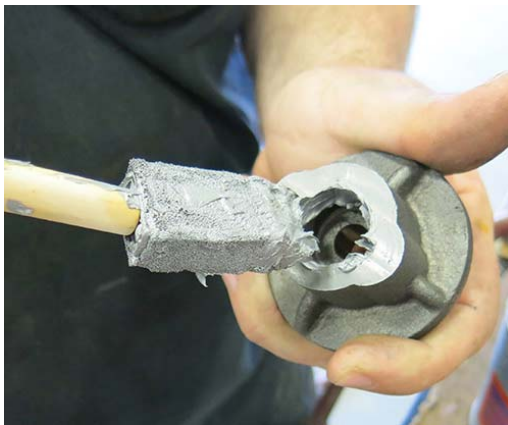

Anti-Seize Lubricant Application
-Typical View

7. Install Cutter Blade Adapter Plug onto center of blade.

NOTE: Ensure adapter plug is installed on the "edged" side of blade, as shown.



- Install Cutter Blade Adapter Plug onto center of blade

8. Assemble Retaining Bolt, Lock Washer, and Steel Washer together, as shown.

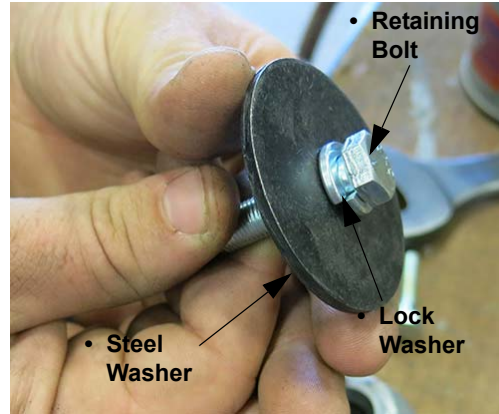

Cutter Blade Bolt/Washer Assembly
-Typical View

9. Insert Cutter Blade Bolt/Washer Assembly through bottom of blade/adapter plug.



Cutter Blade Assembly
-Typical View

10. Install Cutter Blade Assembly through bottom side of Cutter Head (as shown) and tighten Retaining Bolt using a 9/16" socket.

NOTE: Inspect and tighten Retaining Bolts daily.



Cutter Blade Assembly
(Mounted on the bottom side of Cutter Head)
-Typical View

NOTE: Repeat Steps 6-10 for each Cutter Head.

11. Install Cutter Head Extension Flap on the rear side of the center four (4) Cutter Heads.



Cutter Head Extension Flap
-Typical View

12. Install hydraulic hoses.

NOTE: Refer to your Parts Manual for correct hardware, hose lengths, and hydraulic schematics.

Quad Puller Assembly

NOTE: Some Quad Pullers may come pre-assembled to the tool bar.

⚠ CAUTION



RISK OF INJURY FROM ROTATING TIRES. DO NOT PLACE FINGERS OR HAND NEAR MOVING QUAD PULLER TIRES, DISLodge A WEDGED OBJECT FROM MOVING TIRES, OR PERFORM MAINTENANCE NEAR MOVING TIRES.

NOTICE

Ensure quad puller tires have equal pressure. Check tire pressure daily.

NOTE: Refer to your Parts Manual for specific hardware used.

1. Install two (2) Quad Pullers on each lift head tube, as shown.



Quad Puller
-Typical View

2. Ensure each Quad Puller measures 16" (40.6 cm) from the outside of the mount head to the outside of the quad puller mounting tube, making adjustments as necessary.

NOTE: Distance may vary depending on planting pattern.

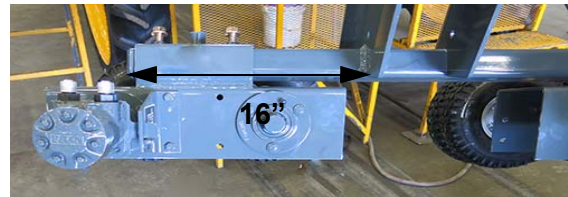

- Measure 16" (40.6 cm) from the outside of the mount head to the outside of the quad puller mounting tube

3. Using a 3/4" socket, tighten each Quad Puller Bolt (two on each Quad Puller Mounting Tube).



Quad Puller Bolts
(Located on each
Quad Puller Mounting Tube)
-Typical View

4. Install two Stalk Guides onto each Quad Puller, positioned as shown.
 - Install four (4) Stalk Guide Bolts (2 each side) through the front side of each Stalk Guide/Quad Puller.
 - Install four (4) Stalk Guide Nuts (2 each side) onto the bolts and tighten with a 7/16" socket.



- Install four (4) Stalk Guide Bolts through the front side of each Stalk Guide/Quad Puller



- Install four (4) Stalk Guide Nuts onto the bolts and tighten with a 7/16" wrench



Stalk Guide Installation
-Typical View

5. Install Deflector Shield Mounting Tube onto each Quad Puller (as shown) and tighten bolts with 7/16" wrench.

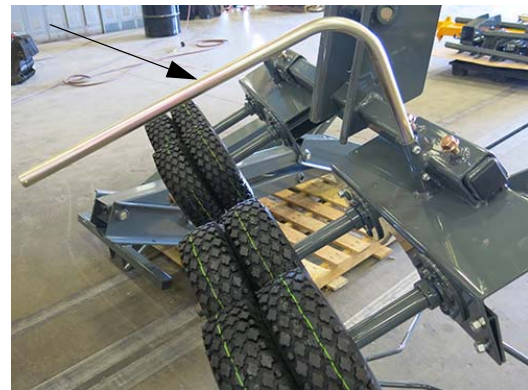

Deflector Shield Mounting Tube
-Typical View

6. Install Deflector Shield onto Deflector Shield Mounting Tube and tighten bolts with 1/2" wrench.

NOTE: Always mount Deflector Shields to direct tassels away from machine.

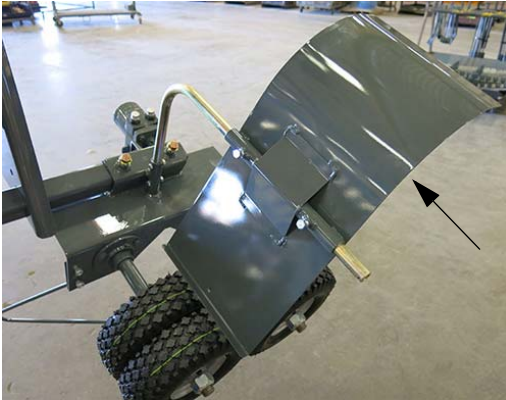

Deflector Shield
-Typical View

7. Install Cotter Pin on the end of each Deflector Shield Mounting Tube.



Cotter Pin
-Typical View

8. Install hydraulic hoses.

NOTE: Refer to your Parts Manual for correct hardware, hose lengths, and hydraulic schematics.

9. Adjust tire pressure to approximately 10 psi (.7 bar).

LS System/Depth Command Assembly

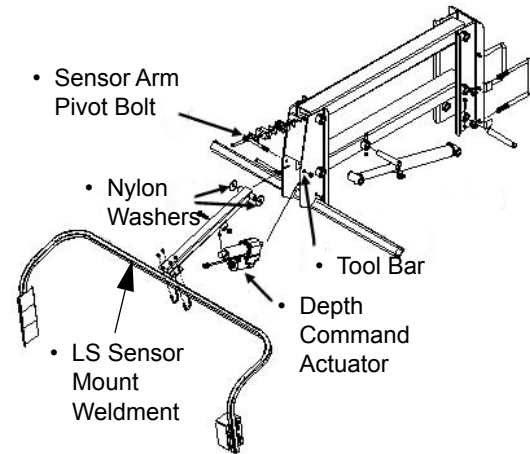

-Typical View

1. Install the LS Sensor Mount Weldment with the two Nylon Washers in the forward-most hole of the Tool Bar.
2. Install the LS Sensor Mount Weldment to the Sensor Mount (located on the support arm).
3. Install the Cable Assembly according to the wiring diagram provided in your Parts Manual.
4. Check sensor installation by turning the ignition key to the ON position. DO NOT start the engine.
5. Attach the Depth Command Actuator to the Light Sensor Mount and Tool Bar.

NOTICE

Over-tightening of the Sensor Arm Pivot Bolt may cause the actuator to stall.

LS Photo Light Sensors

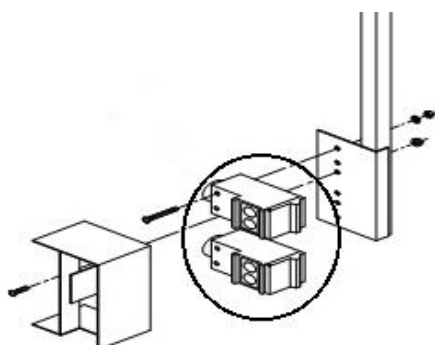

LS Photo Lights (Upper/Lower)
-Typical View

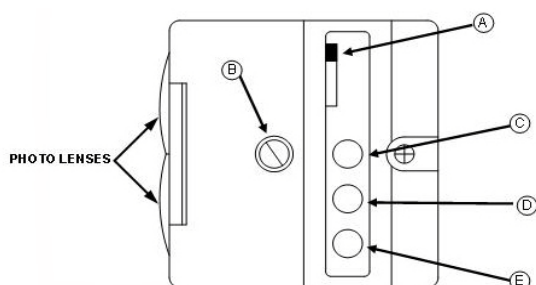

-Typical View

- The upper and lower LS Photo Lights are equipped with LED lights (A, C, D, E) that indicate operation status.
- The LT/DK (Light/Dark) Switch (A) (located on the photo light sensor) changes the activated condition of the green LED from ON (LT) to OFF (DK).
- The Sensitivity Adjustment Screw (B) should always be set to MAXIMUM.
- The Yellow LED Light (C) indicates the power is ON.
- The Green LED Light (D) indicates output energized (sending a signal to the Tasseltrol Control Panel).
- The Red LED Light (E) indicates that the photo light is receiving reflected signal.

Detasseling Control Panel

The Detasseling Control Panel houses switches which activate Depth Command, Left/Right Fold, All-Up/Down, and Detasseling Head Motor functions.



Detasseling Control Panel
-Typical View

Tasseltrol/LS System 12 Control Panel

The Tasseltrol/LS System 12 Control Panel is used for programming the detasseling heads. The control panel can also be used to manually control the detasseling heads.



Tasseltrol/LS System 12 Control Panel
-Typical View

All-Up/Down Switches

The All-Up/Down Switches (located on the Hydrostatic Drive Control Handle and the Detasseling Control Panel) are used to raise or lower all row units at the same time.

- Press desired switch in the UP or DOWN position to raise or lower all row units.



All-Up/Down Switches
(Located on the Hydrostatic
Drive Control Handle)
-Typical View

NOTE: Refer to the manufacturer's operation manual for programming instructions.



Tasselrol Control Panel
-Typical View

2. Test the Photo Light Sensors.

Auto Mode:

- Cover top photo lens and lift should move UP.
- Do not cover any of the lenses and lift should move DOWN.
- Cover bottom photo lens and lift should stay in position.

Manual Mode (Machine Off):

- When red LED (see E on previous page) is uncovered, LED should be ON.
- When red LED is covered, LED should be OFF.



All-Up/Down Switch
(Located on the
Detasseling Control Panel)
-Typical View

Refer to the Tasselrol manufacturer's operation manual for information on programming parameters.

DETASSELING SYSTEM - OPERATION

Operating Instructions

1. Program the Tasselrol®/LS System 12™ Control Panel.



Photo Light Sensor
-Typical View

3. Engage the parking brake.
4. Start the engine.
5. Press the Field/Road Button (located on the Machine Display Home Page) and place the machine in Field Mode.

NOTE: Selected drive state will illuminate.



Field/Road Button
(Located on the Machine Display Home Page - Road and Field Mode)

6. Press the corresponding Motor Control Switches (located on the Detasseling Control Panel) in the UP position to turn desired detasseling head motors ON.



Motor Control Switches
(Located on the Detasseling Control Panel)
-Typical View

7. Press the Main Control Switch (located on the Hydrostatic Drive Control Handle) to the ON position.



Main Control Switch
(Located on the Hydrostatic Drive Control Handle)
-Typical View

NOTE: If loss of hydraulic pressure occurs or the low oil warning indicator appears on the Machine Display, shut down the system immediately. Failure to comply may result in system damage and will void the warranty.

8. Press the Throttle Switch (located near the Hydrostatic Drive Control Handle) in the UP position to achieve the recommended RPM to operate the detasseling head motors.

NOTICE

Operating the Detasseling System below the recommended 2300 engine RPM will not provide the system with adequate hydraulic oil flow and may cause degraded or poor performance.



Throttle Switch
(Located near the Hydrostatic
Drive Control Handle)
-Typical View

NOTE: Detasseling heads will be available for immediate use by increasing engine RPM.

4-2 DETASSELER COMBO ATTACHMENT - ADJUSTABLE

-If Equipped



4-2 Detasseler Combo Attachment
(Retracted View)



• RH Slide Extension

• LH Slide Extension

4-2 Detasseler Combo Attachment
(Extended View)

Unfolding the Attachment

1. Press and hold the corresponding Left/Right Fold Switch (located on the Detasseling Control Panel) in the DOWN

(Unfold) position until outriggers fully extend.

2. Continue to press and hold switch to extend the left and right Slide Extensions.



Left/Right Fold Switches
(Located on the Detasseling Control Panel)
-Typical View

NOTE: If the left or right Slide Extensions extend before the outriggers are unfolded, adjust Sequence Valves SE1 (left) and/or SE3 (right) (located on the Valve Block) by turning the corresponding Adjustment Screw(s) in the “clockwise” position to allow the outriggers to unfold first. If the left or right Slide Extensions do not extend after the outriggers have been unfolded, adjust Sequence Valves SE1 (left) and/or SE3 (right) by turning the corresponding Adjustment Screw(s) in the “counter-clockwise” position to allow the Slide Extensions to extend.

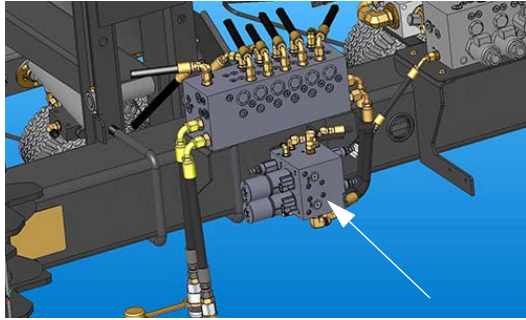

Valve Block
(Located on the front side of attachment)
-Typical View

To Adjust Sequence Valves:

NOTE: Sequence Valves are labeled on the Valve Block.

- Using a 9/16” wrench, loosen Lock Nut(s).
- Using a 5/32” hex wrench, turn Adjustment Screw(s) in the desired position.
- Re-tighten Lock Nut(s) to 7 ft.-lbs.

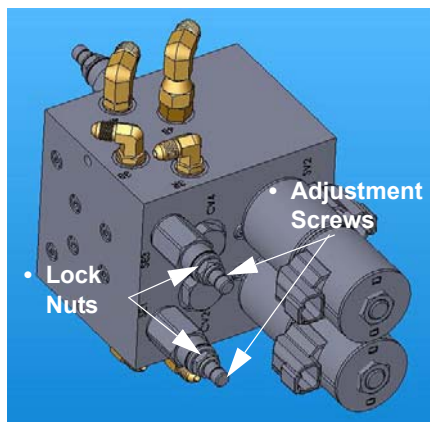

Lock Nuts/Adjustment Screws
(Located on the Valve Block)
-Typical View

Folding the Attachment

NOTICE

Ensure slide extensions are retracted before folding the outriggers in. Failure to comply will result in property damage.

NOTICE

Stagger detasseling heads before folding the outriggers. Failure to comply will result in property damage. Refer to “Transporting” in the *Miscellaneous Section* elsewhere in this manual for further information.

1. Press and hold the corresponding Left/Right Fold Switch (located on the Detasseling Control Panel) in the UP (Fold) position until the Slide Extensions fully retract.
2. Continue to press switch until the outriggers fold in completely.



Left/Right Fold Switches
(Located on the Detasseling Control Panel)
-Typical View

NOTE: If the outriggers fold in before the Slide Extensions retract, adjust Sequence Valves SE2 (left) and/or SE4 (right) (located on the Valve Block) by turning the corresponding Adjustment Screw(s) in the “clockwise” position to allow the Slide Extensions to retract first. If the outriggers do not fold in after the Slide Extensions have been retracted, adjust Sequence Valves SE2 (left) and/or SE4 (right) by turning the corresponding

Adjustment Screw(s) in the “counter-clockwise” position to allow the outriggers to fold in.

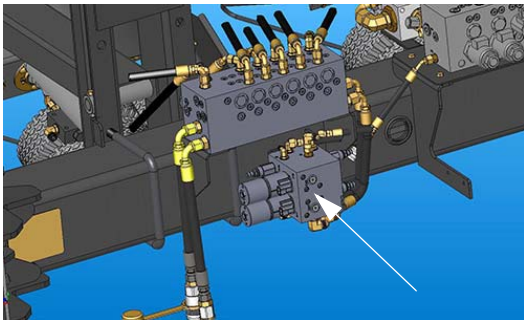

Valve Block
(Located on the front side of attachment)
-Typical View

To Adjust Sequence Valves:

NOTE: Sequence Valves are labeled on the Valve Block.

- Using a 9/16” wrench, loosen Lock Nut(s).
- Using a 5/32” hex wrench, turn Adjustment Screw(s) in the desired position.
- Re-tighten Lock Nut(s) to 7 ft.-lbs.

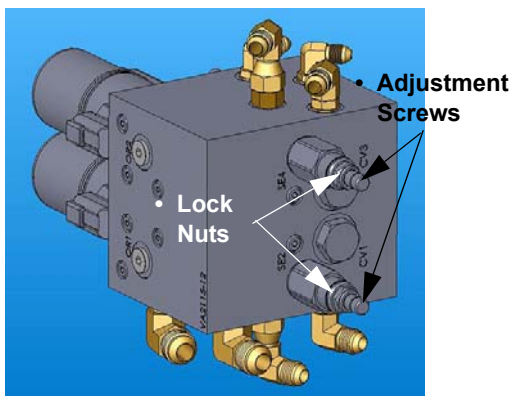

Lock Nuts/Adjustment Screws
(Located on the Valve Block)
-Typical View

TASSELTROL®/LS SYSTEM 12™

Setting Up

Enter Parameter Mode

- Press the Auto/Manual Switch (located on the Tasseltrol Control Panel) and select AUTO.

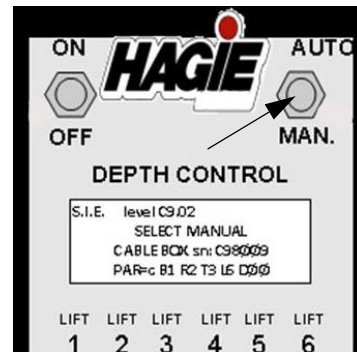

(Located on the Tasseltrol Control Panel)

- Press the On/Off Switch (located on the Tasseltrol Control Panel) in the UP (On) position.
- On the LCD display will be four lines. The top line displays the program level. The second line will flash “Select Manual” (as a warning that you are about to enter the parameter adjustment mode). Current parameter settings are displayed on the bottom line (values for B, R, T, L, and D are typically set). The machine type will vary from x, o, p, or c, depending on the valve system.

NOTE: “L” may vary, depending on the number of lifts on the machine.

```
S. I. E.      level C9.02
                SELECT MANUAL
CABLE BOX sn: C98009
PAR=c B1 R2 T3 L6 D00
```

NOTICE

Machines with Tasselrol software version 8.7 and greater have an enhancement that allows the operator to set the lift speeds for auto mode functions.

Match the Machine Valve Type

NOTICE

Ensure the machine valve type is selected correctly to match the machine in which the Tasselrol Control Panel is installed on.

- Press the LIFT 1 UP Switch (located on the Tasselrol Control Panel) **two times** to display the machine type selected.

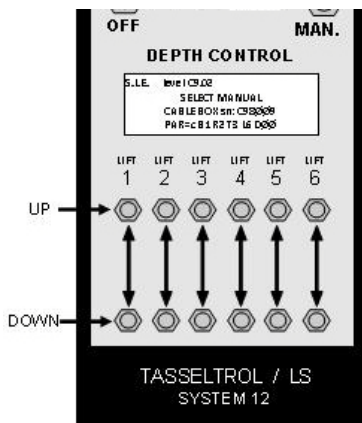

- The x, o, p, or c (located to the right of “NEXT” on the bottom line of the LCD display) indicates the type of machine. Press the LIFT 2 UP Switch. The display will now change to the “Select Machine Type” screen.

```

o= original valves
p= proportional
c= combo      x= 204XP
NEXT  x   o   p   c
    
```

- Select the type of machine that the unit is installed on.

NOTE: For machines built prior to 2007 with the original valve system, press the LIFT 4 Switch under the “o”. If the machine is equipped with proportional valves, press the LIFT 5 Switch under the “p”. For machines built 2007 or newer with proportional valves, press the LIFT 6 Switch under the “c”.

- The display will now revert back to the “Select Manual” screen with the machine type that you have just selected displayed on the bottom line.

Match How Many Lifts are on the Machine

(System must be in parameter mode before proceeding)

- Press the LIFT 1 UP Switch **two times** to display how many lifts are on.

NOTE: “L6” on the display indicates that all six lifts are ON. This should always be set to L6.

```

PRESS UP TO CHANGE
PARAMETERS
PRESS DOWN TO QUIT
NEXT c L6 D00 V1
    
```

- To change the number of lifts to match your machine, press the LIFT 3 UP Switch. This will display the LIFTS: ON-OFF screen.

```

LIFTS: UN _ LIFT
1 2 3 4 of 6
    
```

- Press the LIFT UP Switch under the corresponding lift that you want to turn on/off.

NOTE: “of” = OFF.

- After selecting which lifts are to be on/off, press the LIFT 1 DOWN Switch **two times** to exit the screen and save new parameter setting.

Your machine is equipped with six (6) hydraulic lift hoses, regardless of the number of lifts available. For machines with less than six lifts, unused lift hydraulics will be capped off. When matching how many lifts are on your machine, program the correct number of lifts into the display to ensure maximum performance.

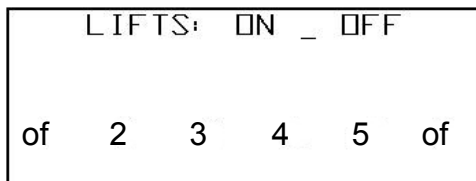

4-Lift Machine

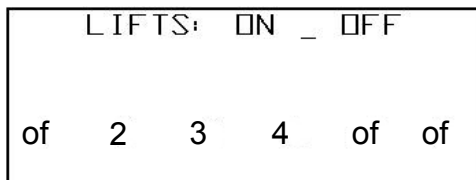

3-Lift Machine

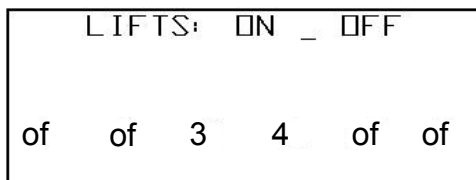

2-Lift Machine

Establish “D” and “V”

(System must be in parameter mode before proceeding)

- Press the LIFT 1 UP Switch **two times** and the display will show the current setting of **Dwell (A)** for “all up” and **Valve Compensation (B)** as either 1=ON, or 0=OFF.

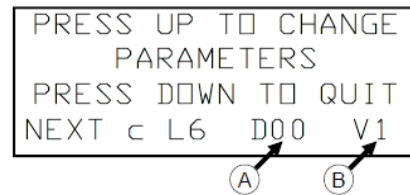

- The “D” value indicates how many seconds that the lifts will travel up after the All Up Switch (located on the Hydrostatic Drive Control Handle or the Detasseling Control Panel) is pressed momentarily. This time can be changed by pressing the LIFT 4 UP Switch.

NOTE: The time is factory preset to 0, but can be set to a value of 25 while adjusting the machine valves.

- Pressing the LIFT 4 UP Switch will add five (5) seconds to the value each time until “D25”, then will return to “D00”. When the value is set to D00, the up motion stops as soon as the All Up Switch is released. If the value is set to anything greater than D00, the All Up Switch will only need to be pressed momentarily and the lifts will continue the up move until the parameter has been reached.
- The “V” value indicates whether or not the valve automatic compensation is performed. Press the LIFT 6 UP Switch to change this value.

NOTE: This value is typically left at “V1”.

Set the Lift Up Speeds

(System must be in parameter mode before proceeding)

- Press the LIFT 1 UP Switch **three times** and the display will show the current setting of the Up Speed for an auto, manual, and all-up move with a value from 01 to 10.
- With the value set to 01 in “MAN” or to 03 in “AUTO” and “ALL”, the lifts will move slow enough to see if any are moving slower than the rest. These settings are useful for adjusting the offset of the values to get all the lifts to move at the

same speed. Typically, these values are set to 05 for a fairly fast speed. The values can be changed by pressing the Up/Down Switches under AUTO, MAN, or ALL.

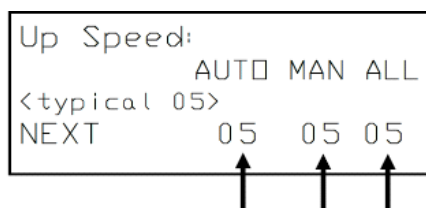

NOTE: Values can be saved by pressing the LIFT 1 DOWN Switch to exit screen and save the new parameter setting.

Set the Lift Up Offset

(System must be in parameter mode before proceeding)

- Press the LIFT 1 UP Switch **four times** and the display will show the current setting of the Up Offset for the first three lifts. Pressing NEXT again will show the offset setting for the last three lifts. The Up Offset for each valve can be set from -19 to +20, as needed to get the lift speed to match the speed of the other lifts.

NOTE: The more positive the number, the faster the lift will move. Typically, the offset is initially adjusted at a very slow speed by setting the Lift Up Speed to either 01 or 03.

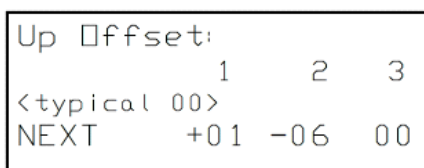
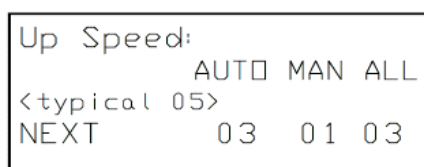

- Exit parameter mode and check the speed of each lift by moving it manually with the Up/Down Switches.

- Correct the fastest and slowest lifts to match the average speed by changing the offset value with the Up/Down Switches for that lift while in the Lift Up Offset parameter.
- When finished setting the offset values, return the speed setting back to approximately 05.

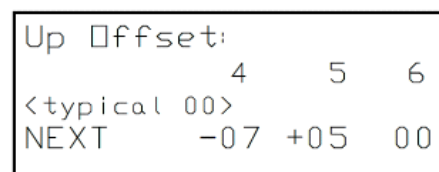

- With all the lifts at their lowest points, select AUTO.
- Press the All Up Switch (located on the Hydrostatic Drive Control Handle or the Detasseling Control Panel) so the lifts all move up at the same time. Correct the values for any lifts that are not close to the speed of the others.

NOTE: Values can be saved by pressing the LIFT 1 DOWN Switch to exit the screen and save the new parameter setting.

NOTICE

To get all the lift speeds even, you may need to lower the speed below 05. This will ensure that the flow is being controlled by the value rather than restricted by the .042" (.1 cm) orifice. After adjusting the offset parameters for even up speeds, the up speed value can be increased back to 05.

Set the Lift Down Speeds

(System must be in parameter mode before proceeding)

- Press the LIFT 1 UP Switch **six times** and the display will show the current setting of the down speed for an auto, manual, and all-resume move with a value of 01 to 10.

- With the value set to 03, the lifts will move a little slower. This setting of 03 is useful when adjusting the offset of the values for getting all the lifts the same speed.

Typically, these values are set to 05 for a fairly fast speed. The values can be changed by pressing the Up/Down Switches under the AUTO, MAN, or ALL.

NOTE: Values can be saved by pressing the LIFT 1 DOWN Switch to exit the screen and save the new parameter setting.

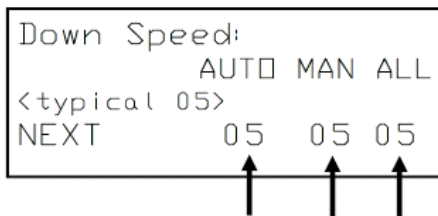

Set the Lift Down Offset

(System must be in parameter mode before proceeding)

- Press the LIFT 1 UP Switch **seven times** to display the current setting of the Down Offset for the first three lifts.
- The Down Offset can be adjusted for a value from -19 to +20.

NOTE: The more positive the number, the faster the lift will move. Typically, the offset is initially adjusted at a slower speed by setting the Lift Down Speed to 03.

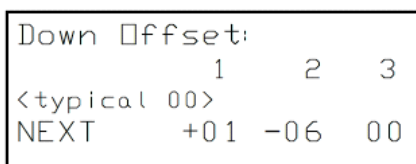
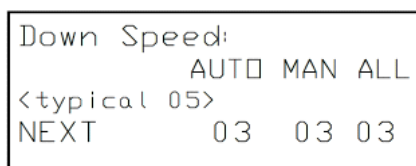

- Exit parameter mode and check the speed of each lift by moving it manually with the Up/Down Switches.
- Correct the fastest and slowest lifts to match the average speed by changing the offset value with the Up/Down Switches for that lift while in the Down Offset parameter.
- When finished setting the offset values, return the speed setting back to approximately 05.
- With all lifts at their highest points, select AUTO so all lifts move down together. Correct the values for any lifts that are not close to the speed of the others.

NOTE: Values can be saved by pressing the LIFT 1 DOWN Switch to exit the screen and save the parameter setting.

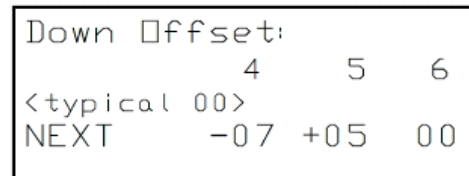

Once you have set the operating parameters, you can adjust the Response Parameters. These parameters are used to adjust the response of the controller and seldom need changing. The parameter values are stored in flash memory and will be retained even when no battery power is present.

NOTICE

Once parameters have been set, minimal adjustment is required.

The programmable control panel is factory preset with the following parameter defaults:

- **Response Parameter (R2)**

- **Top Parameter (T3)**
- **Bottom Parameter (B1)**

These parameters will always be displayed until the control panel is reprogrammed. Once reprogrammed, the new values for the parameters will be displayed on the control panel.



To program the unit, first select the Response Parameter. If further adjustment is required for top and/or bottom parameters, continue with their adjustments.

Tasselrol Response Parameter

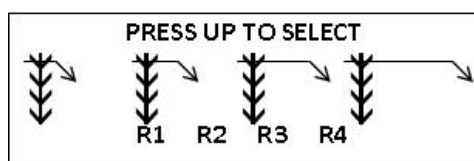
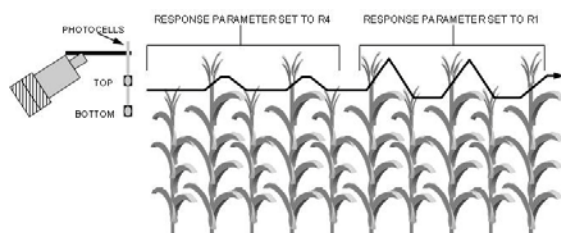

The Response Parameter is used to adjust the response time of both photocells - how quickly the down motion starts when no corn is detected by either top or bottom cells, and how quickly the up motion is stopped when corn is no longer detected by the top cell. This can be changed by selecting R1, R2, R3, or R4.

NOTE: More corrections will occur when R1 is selected and fewer with R4 selected. The normal (default) value for this parameter is R2, but can be set to any desired value.

Use the Response Parameter to adjust overall correction activity and to compensate for ground speed. If the quad pullers are moving too quickly and frequently, the Response Parameter can be increased toward R4. If the quad pullers are too slow to respond to changes in the corn depth, decrease the parameters toward R1. Generally, this parameter can be left at R2.

To display the Response Parameter:

- Press the Auto/Manual Switch (located on the Tasselrol Control Panel) in the UP (Auto) position.
- Press the On/Off Switch (located on the Tasselrol Control Panel) in the UP (On) position. Wait approximately three (3) seconds for the “Select Manual” message to appear.
- Press the LIFT UP Switch under “PAR”.
- Press the LIFT UP Switch under the “R” value.

The active value of the parameter is indicated by it blinking on and off while the other three options are displayed continuously.

To select a new value for the parameter:

- Press the LIFT UP Switch under the desired selection.
- After selecting one of the four options, press the LIFT 1 DOWN Switch to escape this parameter.
- To save new values and escape the parameter mode, press the LIFT 1 DOWN Switch a second time.

Tasselrol Top Parameter

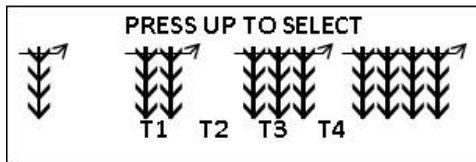
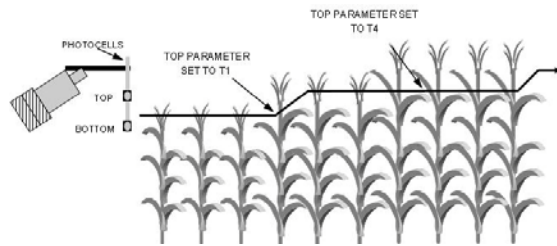

The Top Parameter is used to adjust the sensitivity time of the top photocell. The top photocell starts the up motion when its light path is blocked by corn. How much corn it has to see before starting the up move can be changed by selecting one of the four values: T1, T2, T3, or T4.

NOTE: When T1 selected, less corn is required to start an up move. The normal (default) value for this parameter is T3, but can be set to any desired value.

If the quad pullers move up too easily when a taller stalk of corn passes, increase the parameter toward T4. If the quad pullers stay deep too long when taller corn passes, decrease the parameter toward T1. Generally, this parameter can be left at T3.

To display the Top Parameter:

- Press the Auto/Manual Switch (located on the Tasselrol Control Panel) in the UP (Auto) position.
- Press the On/Off Switch (located on the Tasselrol Control Panel) in the UP (On) position. Wait approximately three (3) seconds for the “Select Manual” message to appear.
- Press the LIFT UP Switch under “PAR”.
- Press the LIFT UP Switch under the “T” value.

The active value of the parameter is indicated by it blinking on and off while the other three options are displayed continuously.

To select a new value for the parameter:

- Press the LIFT UP Switch under the desired selection.
- After selecting one of the four options, press the LIFT 1 DOWN Switch to escape this parameter.
- To save new values and escape the parameter mode, press the LIFT 1 DOWN Switch a second time.

Tasselrol Bottom Parameter

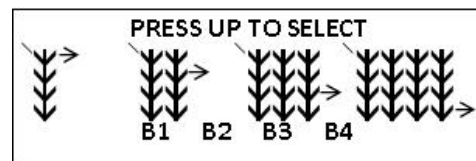
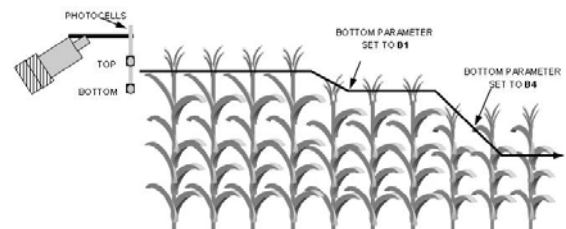

The Bottom Parameter is used to adjust the sensitivity time of the bottom photocell. The bottom photocell stops the down motion when its light path is blocked by corn. Selecting one of the four values (B1, B2, B3, or B4) will set how much corn the photocell has to see before it stops moving down.

NOTE: When B1 is selected, the down move will stop as soon as corn is detected. The normal (default) value for this parameter is B1, but can be set to any desired value.

If the quad pullers run too shallow after moving down into shorter corn, increase the parameter toward B4. If the quad pullers move too deep when going into shorter corn or oscillates between the top and bottom

photocells, decrease the parameter toward B1. Generally, this parameter can be left at B1.

To display the Bottom Parameter:

- Press the Auto/Manual Switch (located on the Tasseltrol Control Panel) in the UP (Auto) position.
- Press the On/Off Switch (located on the Tasseltrol Control Panel) in the UP (On) position. Wait approximately three (3) seconds for the “Select Manual” message to appear.
- Press the LIFT UP Switch under “PAR”.
- Press the LIFT UP Switch under the “B” value.

The active value of the parameter is indicated by it blinking on and off while the other three options are displayed continuously.

To select a new value for the parameter:

- Press the LIFT UP Switch under the desired selection.
- After selecting one of the four options, press the LIFT 1 DOWN Switch to escape this parameter.
- To save new values and escape the parameter mode, press the LIFT 1 DOWN Switch a second time.

Operating the Control Panel with Normal Parameter Settings

- Engage the parking brake.
- Turn the ignition to the ON position.
- Turn the Tasseltrol Control Panel ON.
- Press the Auto/Manual Switch (located on the Tasseltrol Control Panel) in the DOWN (Manual) position.

NOTE: At this time, the display will read “MANUAL” in addition to other information identifying the control panel.

- Press the individual row switches for up or down movement. An arrow on the display will indicate direction of each lift.

NOTE: “P” indicates pressure, UP is only available on “o-type” machines, and UP/DOWN are available on “p, c, and x-type” machines.

- If the Auto/Man Switch is left in the AUTO position when the unit is first started, the display will tell you to “SELECT MANUAL”. After you have selected MANUAL, switch back to the AUTO position.
- To override the system, press the desired LIFT UP Switch to raise the attachment. When the switch is released, the system will revert back into AUTO mode.
- If the ignition is left on and the Auto/Manual Switch is left in AUTO position, the down coils on the electro-hydraulic valve will lose power after approximately 45 seconds. To reactivate, press the Auto/Manual Switch from AUTO to MANUAL, then back to AUTO.
- The control panel is set up with a feature that if a unit loses contact during operation in AUTO mode, the unit will automatically rise. If this should occur, switch to MANUAL mode and determine cause for the malfunction.

Short Corn Operation

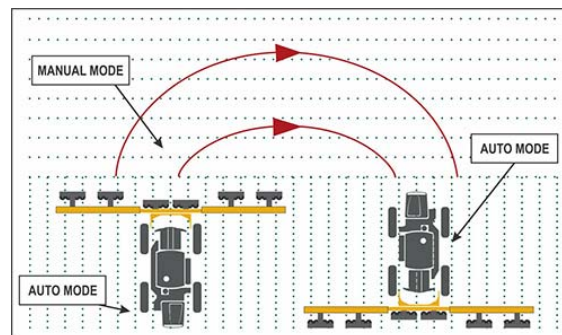

When operating the LS System, always select MANUAL when first entering the field. Once you have determined your operating speed and cutting/pulling depth, select AUTO. When you come to an area where the corn is very short, such as a low

spot in the field, you may want to switch to the MANUAL position until you reach taller corn.

Always switch to the MANUAL position before you reach the end rows (see previous illustration). This will allow the cutter or puller heads to maintain their cutting or pulling height when re-entering the field. Then you may switch back to AUTO.

NOTE: You may choose to use the All Up/ Hold function instead of switching to manual. This function will raise all of the detasseling heads in one motion.

Operating

- Press the All-Up/Down Switch (located on the Hydrostatic Drive Control Handle or the Detasseling Control Panel) in the UP or DOWN position to raise or lower all row units.



All-Up/Down Switches
(Located on the Hydrostatic
Drive Control Handle)
-Typical View



All-Up/Down Switch
(Located on the
Detasseling Control Panel)
-Typical View

All row units will move up when the desired switch is pressed in the UP position and will lower when the switch is pressed in the DOWN position.

The parameters for Dwell on the up move can be set to 0, 5, 10, 15, 20, or 25 seconds. The heads will move up this amount of time without having to hold the All-Up/Down Switch in the up position (only in values greater than 0.) All heads will hold this position when the parameter is reached. To resume automatic depth control, press the All-Up/Down Switch in the DOWN position.

Additional Features

To temporarily lock a lift up, press and hold the LIFT UP Switch for the corresponding lift while switching from MANUAL to AUTO mode. The display will show “L” for that lift, which indicates that it is locked and will not move down automatically.

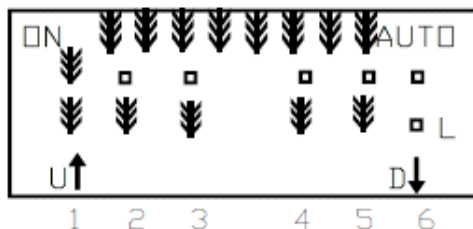

SECTION 8 –
DETASSELING SYSTEMS



NOTE: The lift will return back to normal operation when MANUAL mode is again selected.

To display the current supply voltage for the controller, press the All Up Switch while in MANUAL mode.

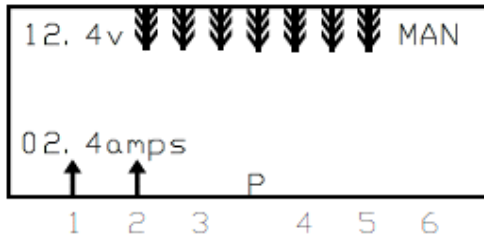

TASSELTROL FLOWCHART

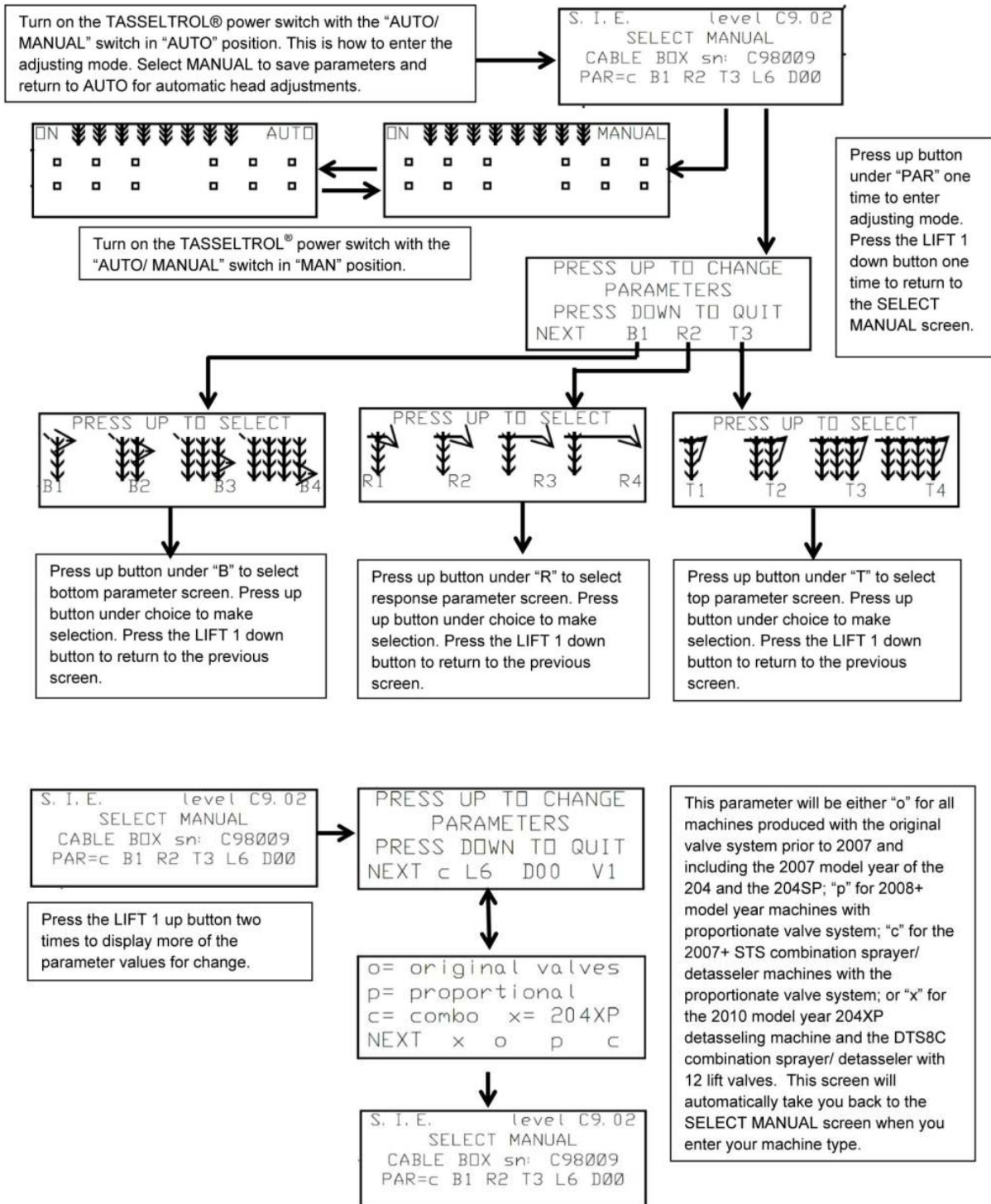

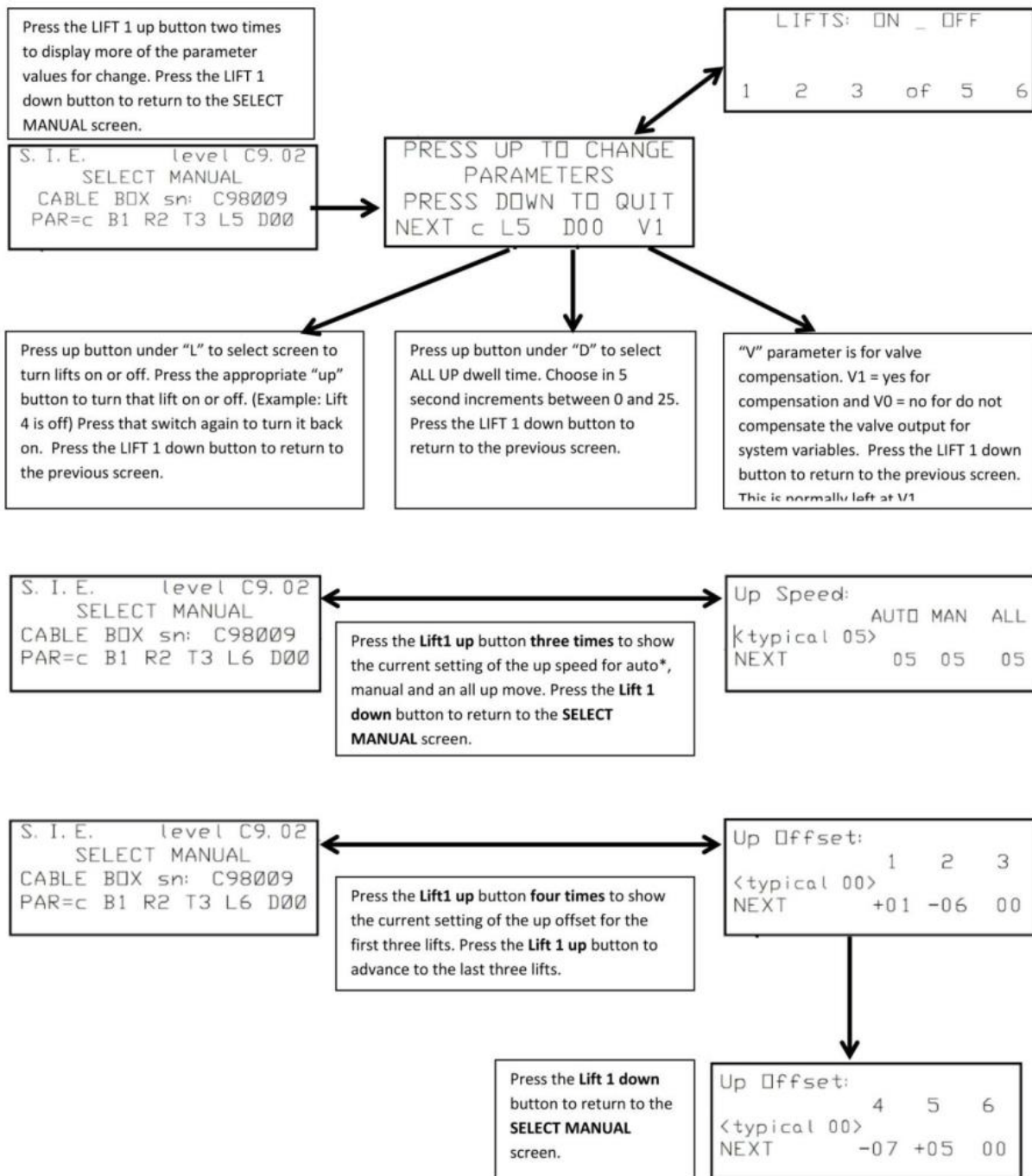

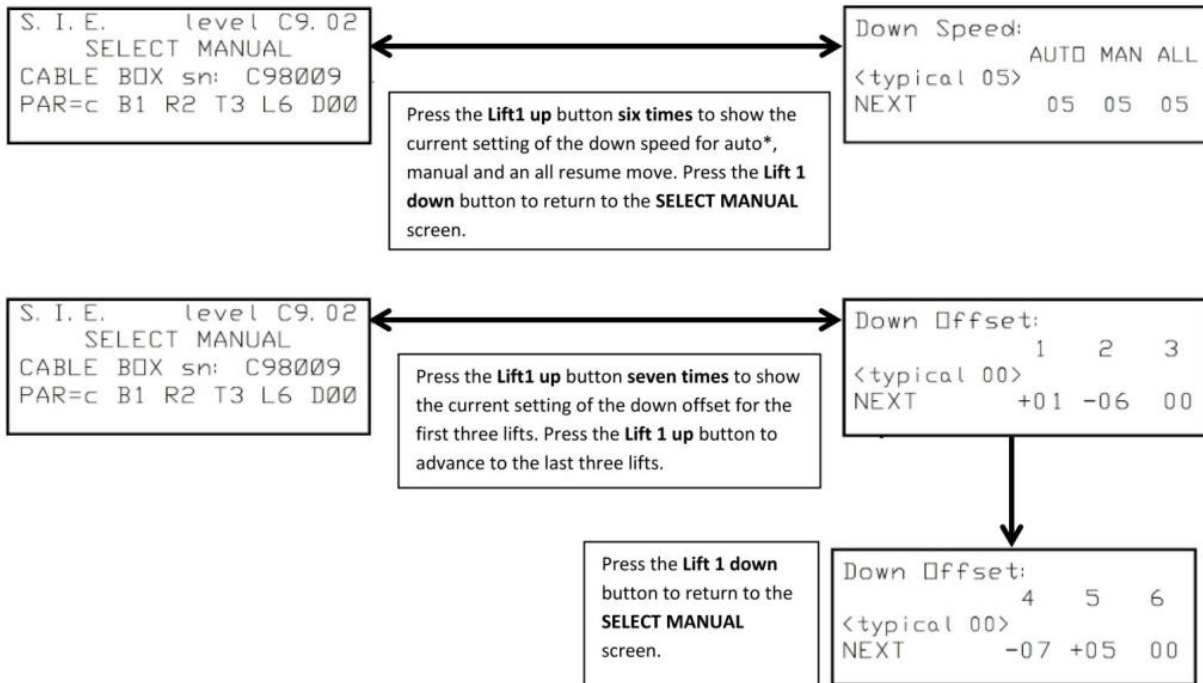

NOTE: With the exception of the machine type screen (which automatically reverts upon changing), you may advance through all the parameter settings while making changes without returning to the SELECT MANUAL screen each time by pressing the LIFT 1 UP Switch instead of the Down Switch. LIFT 1 DOWN saves the changes upon exiting the parameter screen.

KEY

- = reflector with no corn present
- ☛ = the photo cell is blocked by corn
- ↓ = the down valve is on
- ↑ = the up valve is on
- P** = the pressure valve is on. Displayed in the lower middle part of the screen.
- LV** = the source of voltage fell below 10.8 vdc for a low voltage condition. Displayed in the upper left corner of the screen in place of "ON" when situation occurs.
- SHORT** = current exceeded 18 amps and outputs are turned off for a short time. Displayed in place of "ON" when situation occurs.
- t** = task not completed in the 30 seconds allowed, will resume on next task. Displayed in place of "ON" when situation occurs.
- of** = a lift is turned off by the parameter settings
- L** = the operator locked that lift up until manual is selected again. Displayed next to bottom photo cell icon for the valve that is locked.
- ALL HOLD** = the operator pressed the ALL-UP button on the hydrostatic handle. Displayed in the middle of the screen.
- U, D, or B** = either the up, down, or both manual buttons are pressed for that lift. Displayed next to the arrow for the lift being used.

The diagram shows a control panel with six lift stations labeled 1 through 6. Above the stations are indicators for 'ON' and 'AUTO'. Below the stations are indicators for 'U' (up), 'D' (down), and 'P' (pressure). The 'ON' indicator is present above all stations. The 'AUTO' indicator is present above stations 4, 5, and 6. The 'U' indicator is present below stations 1, 2, and 3. The 'D' indicator is present below stations 4, 5, and 6. The 'P' indicator is present below station 3.

SECTION 9 – MAINTENANCE AND STORAGE

NOTICE

Remove all chemical residue from the work area before performing service/ maintenance.

NOTICE

Pump repair and replacement should be performed by qualified service personnel only. Replace with properly rated components. Refer to your parts manual for further information.

*NOTE: Hydraulic oil expands when heated.
Always check oil level when it is cool.*

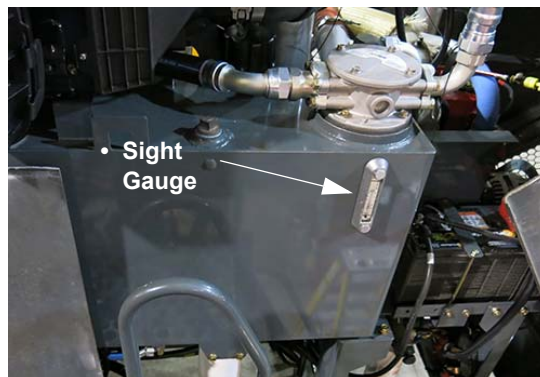

Hydraulic Oil Reservoir
(Located on left-hand side of machine - open hood to access)
-Typical View

SERVICE - FLUIDS

Hydraulic Oil

NOTICE

Ensure area is clean before changing hydraulic oil and filters to avoid contamination, such as dirt and debris. Failure to comply may result in severe hydraulic system damage.

NOTICE

Ensure engine is off before filling hydraulic oil reservoir.

Check the Hydraulic Oil Reservoir Sight Gauge level daily. Add just enough fluid to maintain oil level at mid-sight gauge.

If hydraulic oil level is too low for safe operation, a Low Hydraulic Oil Warning Message will appear on the Machine Display. Press OK to acknowledge and refill hydraulic oil level to satisfactory level.

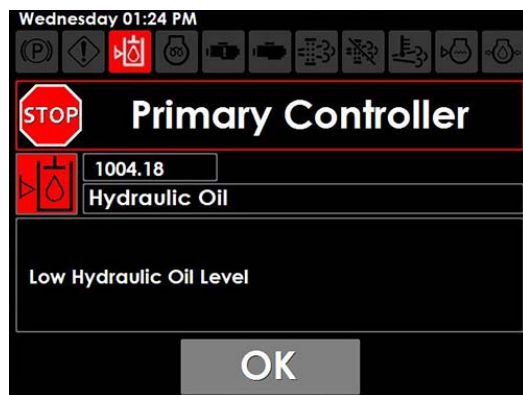

Low Hydraulic Oil Level Warning Message
(Located on the Machine Display)

NOTE: Replace hydraulic oil every 1,000 hours of operation.

Filling the Hydraulic Oil Reservoir

Hydraulic oil can be added two different ways:

1. Through the hydraulic oil fill port (located on the side of the hydraulic return filter housing); or
2. Through the top of the hydraulic return filter housing. Remove bolts and cover to access.

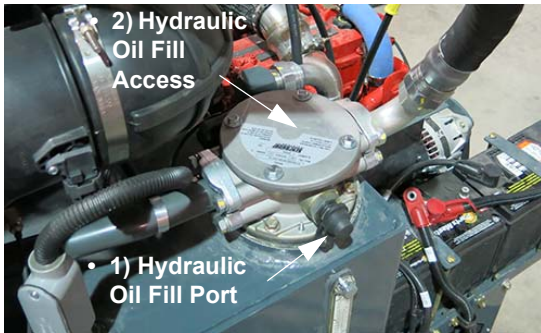

Hydraulic Oil Fill Options
-Typical View

Method 1 - Filling Through Hydraulic Oil Fill Port (Preferred Method)

- Remove the fill port end cap.
- Attach hydraulic oil pump quick-connect fitting to the Hydraulic Oil Fill Port.
- Slowly squeeze pump handle and fill reservoir until oil level reaches mid-sight gauge.

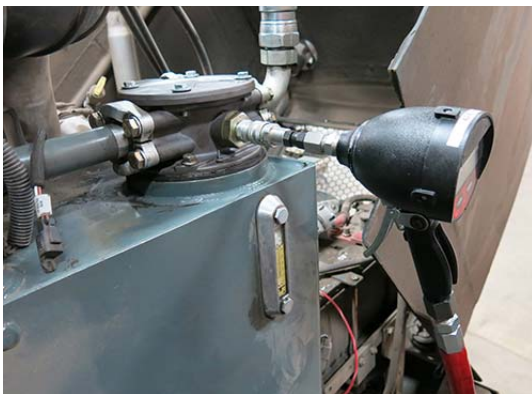

Filling Tank Through Hydraulic Oil Fill Port
-Typical View

- When finished filling, release pump handle and disconnect quick-connect fitting from fill port.
- Reinstall fill port end cap.

Method 2 - Filling Through Hydraulic Return Filter Housing

- Using a 1/2” wrench, remove the four (4) bolts (located on top of the hydraulic return filter housing) and set aside.
- Remove cover and fill reservoir until oil level reaches mid-sight gauge.



Filling Tank Through Hydraulic Return Filter Housing
-Typical View

- When finished filling, reinstall hydraulic return filter housing cover and bolts.

Type

Premium hydraulic fluids containing high quality rust, oxidation, and foam inhibitors are required. Hagie Manufacturing Company recommends Mobilfluid® 424.

Wheel Hub Oil

Bonfiglioli Wheel Hubs

Each wheel hub should maintain a proper oil level at all times. Less than that would limit lubrication and overfilling would cause overheating and machine damage.

To check the oil level:

NOTE: Check wheel hub oil level every 100 hours of operation.

1. Position wheel hub so the bottom (oil drain) face plug is positioned at 6 o'clock (A).

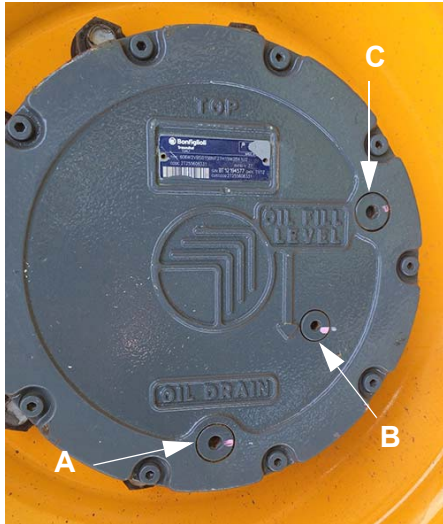

- Remove the 4 o'clock plug (B). **Ensure oil level is between 1/3 and 1/2 full.**

NOTE: Hagie Manufacturing Company recommends Mobil Delvac™ synthetic gear oil (75W-90) with EP features (complying with API GL-5 specifications).

- If oil is needed, remove the top plug (C) and fill until oil level is satisfactory.
- Reinstall plugs.

To change the oil:

NOTE: Wheel hub oil should be changed after the first 50 hours of operation. After that, it should be changed every 250 hours of operation or yearly, whichever occurs first.

- Position wheel hub so the bottom (oil drain) face plug is positioned at 6 o'clock (A).
- Remove bottom plug to drain oil.
- Once all of the oil is drained, reinstall the bottom plug.
- Remove the top plug (C) and fill until oil level is between 1/3 and 1/2 full.

General Maintenance

NOTICE

Failure to rotate the wheel hub and disperse oil may cause rusting and internal wheel hub damage.

If your machine is going to sit unused for an extended period of time, occasionally rotate the wheel hubs by driving the machine forward and backward - at least half of a tire rotation to adequately coat all internal wheel hub parts. This will prevent rusting if moisture inadvertently entered the wheel hub during an oil change.

Fairfield Wheel Hubs

- If Equipped

Each wheel hub should maintain a proper oil level at all times. Less than that would limit lubrication and overfilling would cause overheating and machine damage.

To check the oil level:

NOTE: Check wheel hub oil level every 100 hours of operation.

- Position wheel hub so the bottom (oil drain) face plug is positioned at 6 o'clock (A).

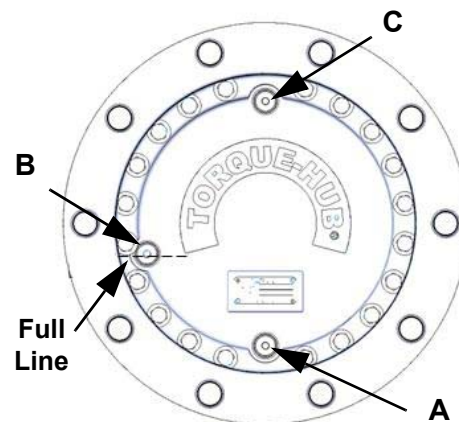

- Remove 8 o'clock plug (B). If no oil comes out, proceed to Step 3.

NOTE: Hagie Manufacturing Company recommends Mobil Delvac™ synthetic gear oil (75W-90) with EP features (complying with API GL-5 specifications).

3. If oil is needed, remove the top plug (C) and fill until oil begins to come out of the 8 o'clock plug (B).
4. Reinstall plugs.

To change the oil:

NOTE: Wheel hub oil should be changed after the first 50 hours of operation. After that, it should be changed every 250 hours of operation or yearly, whichever occurs first.

1. Position wheel hub so one of the face plugs is positioned at 6 o'clock and the other plug is positioned at either the 3 or 9 o'clock positions.
2. Remove plugs to drain oil.
3. Once all of the oil is drained, reinstall the bottom plug and remove the 3 or 9 o'clock plug.
4. Rotate wheel hub to the "fill" position so one of the plugs is positioned at 12 o'clock and the other plug is positioned at either the 3 or 6 o'clock positions.
5. Refill wheel hub with oil until satisfactory level is met.
6. Reinstall plugs.

General Maintenance

NOTICE

Failure to rotate the wheel hub and disperse oil may cause rusting and internal wheel hub damage.

If your machine is going to sit unused for an extended period of time, occasionally rotate the wheel hubs by driving the machine forward and backward - at least half of a tire rotation to adequately coat all internal wheel

hub parts. This will prevent rusting if moisture inadvertently entered the wheel hub during an oil change.

Engine Oil

NOTICE

Never operate the engine with oil level below the "L" (low) mark or above the "H" (high) mark on the engine oil dipstick.

NOTICE

The engine must be level when checking oil level to ensure accuracy.

The Engine Oil Dipstick is located on the left-hand side of the engine (open hood to access). Wait at least five (5) minutes after shutting the engine off to check the oil level.

NOTE: Check the engine oil level daily.



Engine Oil Dipstick
(Located on the left-hand side of engine - open hood to access)
-Typical View

Capacity

- Engine Oil Dipstick (low to high mark capacity) = 2 quarts (1.9 L)

- Engine Oil Pan Capacity (including filter and cooler) = 17.6 quarts (16.7 L)

Type

- Valvoline Premium Blue® Diesel Engine Oil - 15W-40 (recommended)

NOTE: Change the engine oil every 500 hours of operation or yearly, whichever occurs first.

NOTE: Use of any engine oil other than the recommended type (or less than API CJ4 specification) will require the oil to be changed every 250 hours of operation.



Engine Oil Fill
(Located near front of engine)
-Typical View



Remote Engine Oil Fill
(Located on rear left-hand side of machine - open hood to access)
-Typical View

**Diesel Exhaust Fluid (DEF)
(Tier 4 Final Engines)**

WARNING

Read the DEF manufacturer's label and comply with safety precautions to avoid injury or damage.

NOTICE

Never operate the engine with low DEF level. If DEF reaches a level that is too low for safe operation, the engine will begin to derate.

NOTICE

Ensure engine is off before filling the DEF tank.

Check the DEF Gauge (located on the cab A-post) daily. Add just enough DEF to keep the DEF tank full.

DEF Indicator Lamp Status
• When DEF level reaches 10% (indicated on the DEF Gauge), DEF Indicator Lamp will illuminate.
• When DEF level drops to 5%, DEF Indicator Lamp will flash.
• When DEF level drops to 2.5%, initial engine derate begins.
• When DEF level drops to 0%, secondary derate begins.

NOTE: Depending on the selected final inducement option, 30 minutes after the DEF Gauge reads 0%, the engine will either be locked at idle or will

shut down. Refer to the engine manufacturer's service manual for information on how to recover from a low DEF level condition.



DEF Gauge
(Located on cab A-post)
-Typical View

Capacity

- DEF Tank Capacity = 10 Gallons (37 L)

Type

- Use only DEF which meet ISO 2224101 standards.

NOTE: Refill tank with DEF every other fuel fill to maintain adequate fluid level.

Filling the DEF Tank

Refer to “Engine Aftertreatment - Tier 4 Final” provided in the *Engine and Drive Systems Section* elsewhere in this manual for further information.

DEF Storage

DEF has a limited shelf life, both in the machine's DEF tank and in storage containers. The following conditions are ideal for maintaining DEF quality and shelf life during prolonged transportation and storage:

- Store DEF between 23° F (-5° C) and 77° F (25° C).

- Store DEF in sealed containers to avoid contamination.
- Avoid direct sunlight.

By following these conditions, DEF has a minimum expected shelf life of approximately 18 months.

NOTE: When storing DEF in higher temperatures for an extended period of time, the shelf life will be reduced by approximately 6 months for every 9° F (5° C) above the highest storage temperature as previously listed.

Long-term DEF storage in a machine (in excess of 6 months) is not recommended. If long-term storage is necessary, periodic testing of the DEF is recommended to ensure adequate concentration. Having the correct concentration of DEF is critical in engine and aftertreatment system performance.

NOTE: To help prevent DEF deterioration when stored in the DEF tank, locate and plug the tank venting to seal tank exposure against environmental elements.

Checking DEF Concentration

DEF concentration should be checked when the machine has been stored for an extended period of time or if it is suspected that water has been added to the DEF tank.

- Use a refractometer to check DEF concentration.

NOTE: Refer to the engine manufacturer's operation manual for further information on checking DEF concentration.

- If the DEF concentration is found to be inadequate (outside of recommended specification):
 1. Drain the DEF tank.
 2. Flush tank with distilled water.
 3. Refill tank with new DEF.
 4. Recheck DEF concentration.

Freezing

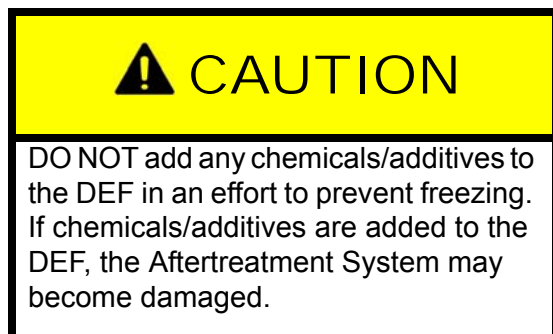

DEF will freeze around 12° F (-11° C). The DEF system on the machine is designed to accommodate this and does not require any operator intervention.

DEF Disposal

Check with local authority regulations on proper DEF disposal requirements.

Cooling System

The cooling system should be sufficiently charged with an adequate mixture of antifreeze and water, regardless of climate, to maintain broad operating temperature range. Follow the coolant manufacturer's recommendations for your climate.

NOTE: The cooling system has been factory-filled with an ethylene glycol-based antifreeze.

Capacity

- Tier 4 Final Engines - 14 gallons (53 L)
- Tier 3 Engines = 12.5 gallons (47L)

Checking Coolant Level/ Concentration

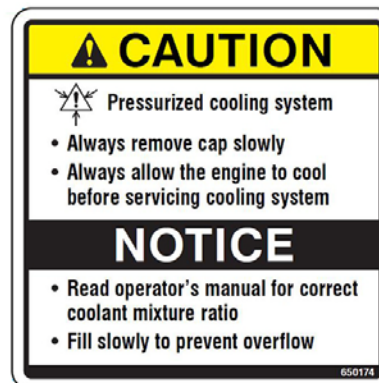

NOTE: Check coolant level daily.

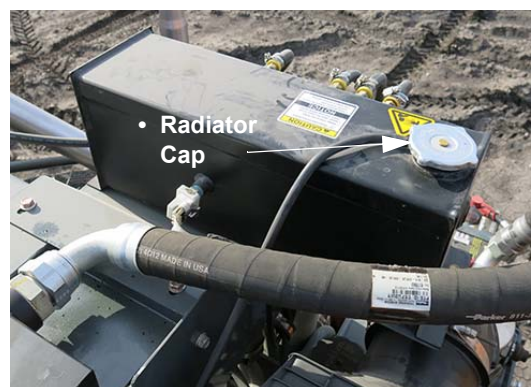

Radiator
(Located near the rear of machine - open hood to access)
-Typical View

A 50/50 ethylene glycol and water mixture is a conservative mixture, which allows protection against both overheating and freezing.

NOTE: If a stronger antifreeze mixture is required, ensure not to exceed the engine manufacturer's guidelines for antifreeze-water mixing. Refer to "ASTM D 6210" or "ASTM D 7715" standards for further information.

The following Ethylene Glycol Table gives a few examples of ethylene glycol antifreeze/water mixture protection values.

Ethylene Glycol		
40%	-23° C	-10° F
50%	-37° C	-34° F
60%	-54° C	-65° F

Coolant concentration should be checked every 500 hours of operation or at the beginning of each spray season, whichever occurs first. A refractometer should be used to check concentration.

NOTE: “Floating Ball” type density testers are not accurate for use with a heavy duty diesel cooling system.

Changing Coolant

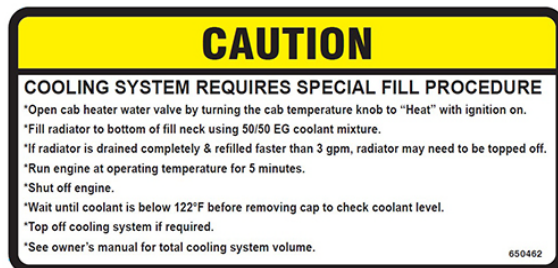

Coolant should be changed periodically to eliminate the buildup of harmful chemicals. Drain and replace the coolant every other spray season or 1,000 hours of operation, whichever occurs first. Refill with soft water only, as hard water contains minerals, which break down the anti-corrosion properties of the antifreeze.

Further Information

Refer to the engine manufacturer’s operation manual for further information.

Engine Fuel

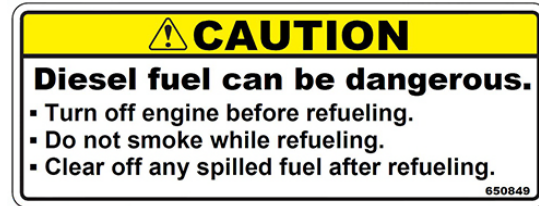

NOTE: Keep a fire extinguisher nearby when refueling.

DO NOT fill fuel tank completely. Fuel can expand and run over. Wipe up all spilled fuel and clean with detergent and water before starting the engine.

Tier 4 Final Engines

- Ultra-Low Sulfur Diesel (ULSD) fuel required.

Tier 3 Engines

- No. 2 diesel fuel recommended. (In operating conditions less than 32° F., use a blend of No. 1 and No. 2 diesel fuel).

NOTE: The addition of No. 1 diesel fuel may cause loss of power and/or fuel economy.

Filling the Fuel Tank

1. Shut the engine off.
2. Remove Fuel Fill Cap and set aside.



Engine Fuel Fill
(Located behind the fuel tank on right-hand side of machine)
-Typical View

3. Fill tank to desired level.
4. Reinstall the Fuel Fill Cap.

Air Conditioning

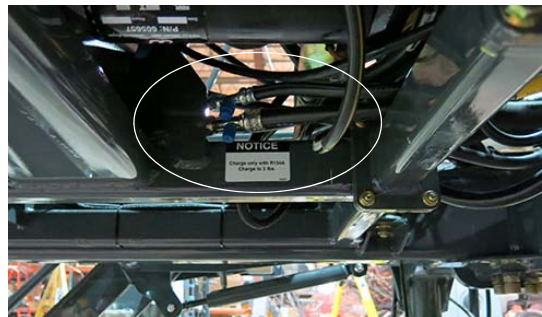
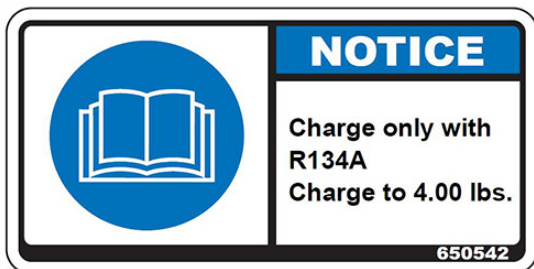

A/C Charge Ports
(Located beneath mid mainframe)
-Typical View

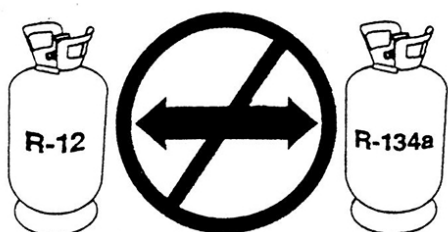

DO NOT MIX REFRIGERANTS

Recharging the AC System

The cab is equipped with an R-134A Air Conditioning System. **Recharge system with R-134A refrigerant only.**

NOTE: Confirm refrigerant before recharging the Air Conditioning System. If your system is mistakenly recharged with R-12 refrigerant, machine damage (such as compressor seizure) may result. If you do not have the proper equipment, it is recommended that you allow an authorized service technician service your Air Conditioning System.

Windshield Washer Fluid

The Windshield Washer Fluid Reservoir is located behind the left-hand side of cab. Check fluid level before each use and fill with non-freezing automotive windshield washer fluid, as required.



Windshield Washer Fluid Reservoir
(Located behind the left-hand side of cab)
-Typical View

SERVICE - FILTERS

Engine Air Intake

The Engine Air Intake Filter is located along the catwalk on the left-hand side of machine (open hood to access).



Engine Air Intake Filter
(Located along catwalk on left-hand side
of machine - open hood to access)
-Typical View

NOTICE

Do not tap filter to remove dust. A crushed filter caused by tapping may result in engine damage. Remove and replace filter as recommended.

Removal

The Engine Air Intake Filter should only be removed if replacement is required.

- Loosen the air cleaner and remove end cap.
- Remove filter. Use care when removing the filter to ensure dust from the filter does not enter the air intake passage.

NOTE: The secondary filter does not need to be replaced if the primary filter is intact.

Replacement

Your machine is equipped with a Filter Minder® to notify you of filter element efficiency.

Cleaning

It is not recommended to clean the Engine Air Intake Filter element. However, a clean damp cloth should be used to wipe away dust and debris from the air cleaner housing.

Filter Minder

The Filter Minder is an air restriction monitoring system that progressively and constantly indicates how much air filter capacity remains.

NOTE: A service interval message will appear on the Machine Display notifying you that Filter Minder replacement is recommended.

Radiator Screen

NOTICE

Failure to keep cooling systems clean can cause overheating and damage to the engine and hydrostatic systems.

To maintain adequate airflow through the engine cooling system, the Radiator Screen (located ahead of rear hood) must be inspected daily and cleaned as necessary.

Removal

- Remove the four (4) Radiator Screen Latches (located on each corner of the screen).

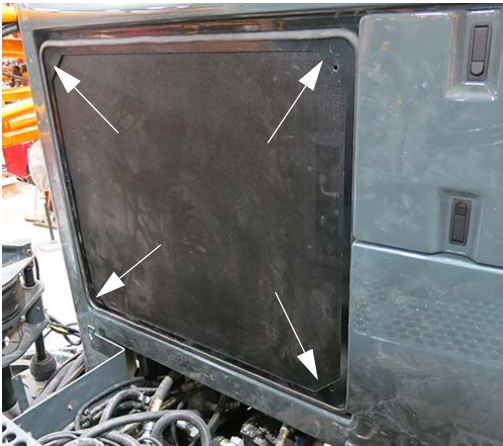

Radiator Screen Latches
(Located on each corner of the screen)
-Typical View



Engine Oil Filter
(Located along left-hand side of
machine - open hood to access)
-Typical View

- Remove Radiator Screen.

Cleaning

Use compressed air to dislodge large debris and dirt. Water from a pressurized hose may also be used or if necessary, the screen may be soaked with soapy water and scrubbed gently with a brush.

NOTE: When cleaning the cooling fins of the radiator, oil cleaner, or A/C condenser with compressed air or water, be careful not to damage the cooling fins, which may impair cooling capabilities.

Engine Oil Filter

The Engine Oil Filter (located along left-hand side of machine - open hood to access) should be replaced every 500 hours of operation or whenever the oil is changed, whichever occurs first.

Refer to the engine manufacturer's operation manual for further information.

Fuel Filters

Primary Fuel Filter (Water Separator)

The Primary Fuel Filter (located along left-hand side of machine - open hood to access) should be drained of water and other deposits daily. Replace the filter every 500 hours of operation or yearly, whichever occurs first.

Secondary Fuel Filter

The Secondary Fuel Filter (located along left-hand side of machine - open hood to access) should be replaced every 500 hours of operation or yearly, whichever occurs first.

Refer to the engine manufacturer's operation manual for further information.

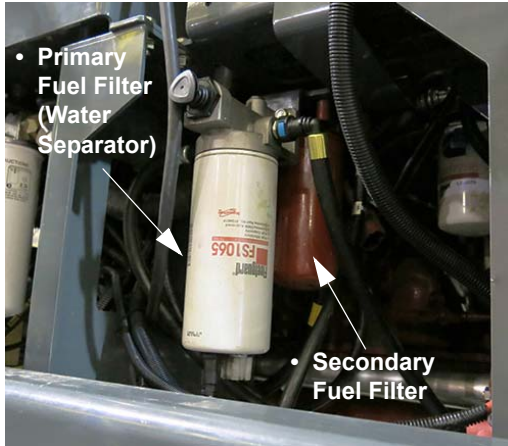

Primary and Secondary Fuel Filters
(Located along left-hand side of
machine - open hood to access)
-Typical View

NOTE: Cummins® recommends specific high performance fuel filters, which will aid in achieving optimum engine performance and efficiency. Refer to the engine manufacturer's operation manual for further information and specifications.

Diesel Exhaust Fluid (DEF) Supply Module Filter (Tier 4 Final Engines)

The DEF Supply Module Filter (located near the bottom of the DEF Supply Module) should be replaced every 4,500 hours of operation or every three (3) years, whichever occurs first.

Refer to the engine manufacturer's operation manual for further information.

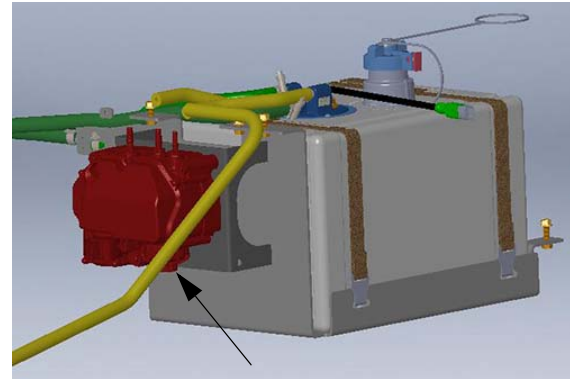

DEF Supply Module Filter
(Located near the bottom
of the DEF Supply Module)
-Typical View

Hydraulic Filters

(Refer to your Parts Manual for specific location and replacement part numbers)

Remove and replace hydraulic filters every 500 hours of operation or yearly, whichever occurs first.

- Return Filter
- Pressure Filter
- Charge Pump Filter
- Case Drain Filter
- Breather Cap

Replacing Hydraulic Filters

Return Filter

NOTE: Replace Return Filter when the filter indicator indicates that replacement is needed, becomes tripped, or after 500 hours of operation, whichever occurs first.

1. Remove the four (4) bolts on top of the Return Filter Housing (located on the left-hand side of machine near hydraulic oil reservoir) and set aside.

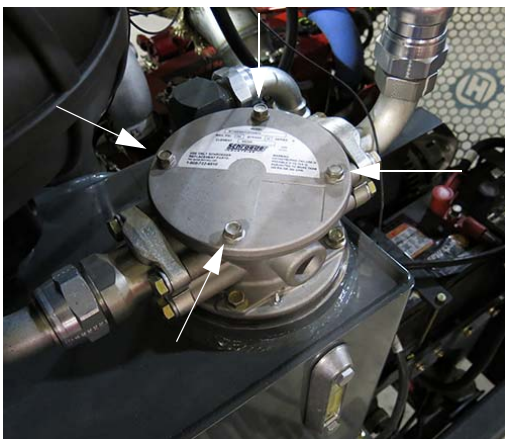

Return Filter Housing
(Located on left-hand side of
machine near hydraulic oil reservoir)
-Typical View

2. Remove Return Filter Housing cover and set aside.
3. Remove and discard used Return Filter.



Return Filter
(Located inside filter housing)
-Typical View

4. Install new Return Filter.
5. Reinstall filter housing cover and bolts.

Pressure Filter

1. Unlatch and lower metal shield (located beneath front end of machine).
2. Using a 15/16” wrench on the Pressure Filter Housing end bolt, turn “counter-clockwise” and remove filter housing.

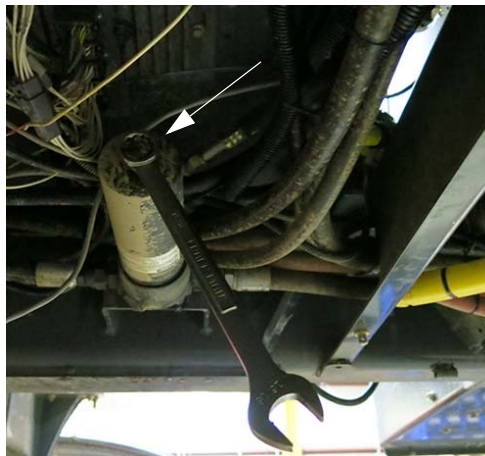

Pressure Filter Housing
(Located beneath right-hand side of
machine - lower metal shield to access)
-Typical View

3. Remove and discard used Pressure Filter.
4. Install new Pressure Filter.
5. Reinstall Pressure Filter Housing and metal shield.

Charge Pump Filter

1. Ensure the engine is shut OFF.
2. Hold the Charge Pump Filter (located beneath the drive pump) in place and remove filter from housing using a 24mm wrench.

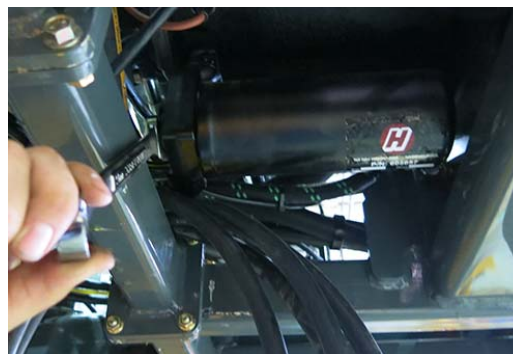

Charge Pump Filter
(Located beneath drive pump)
-Typical View

3. Remove and discard used Charge Pump Filter.

NOTE: Inspect the plug and seal surfaces in the filter bracket. Replace any damaged components.

4. Lubricate the seal and o-ring with hydraulic fluid.
5. Insert plug into filter bracket.
6. Using a 24mm wrench to hold the plug in place, install new Charge Pump Filter.

NOTE: Hand-tighten filter until it makes contact with the o-ring, then tighten half a turn further.

7. Turn the engine ON.
8. Cycle the pump through normal machine operation and check for leaks.

Case Drain Filter

1. Using a 2-inch wrench, loosen Case Drain Hose (located near top of hydraulic reservoir) to prevent siphoning when changing the Case Drain Filter.



Case Drain Hose
(Located near top of hydraulic reservoir)
-Typical View

2. Turn Case Drain Filter (located on left-hand side of machine) to the left to loosen.



Case Drain Filter
(Located on left-hand side of machine)
-Typical View

3. Remove and discard used Case Drain Filter.
4. Install new Case Drain Filter, turning right to tighten.
5. Re-tighten Case Drain Hose.

Breather Cap

1. Loosen Breather Cap (located on left-hand side of machine near return filter housing) by turning “counter-clockwise”.



Breather Cap
(Located on left-hand side of machine near return filter housing)
-Typical View

2. Remove and discard used Breather Cap.

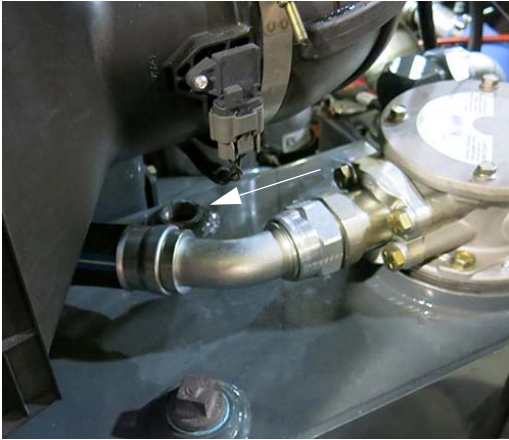

Breather Cap Removed
-Typical View

3. Install new Breather Cap and turn “clockwise” to tighten.

Strainers

(Refer to your Parts Manual for specific location and replacement part numbers)

Tank Rinse Strainer (Main Tank)

The stainless steel solution tank on your machine is equipped with a mesh Tank Rinse Strainer (located near top of the main tank). Inspect the strainer for blockage if you are unable to obtain adequate pressure through your rinse system.



Tank Rinse Strainer
(Located near top of main tank)
-Typical View

Solution Line Strainer

⚠ CAUTION

Ensure the Main Tank Valve and Agitation Valve are CLOSED before servicing the Solution Line Strainer. Failure to comply may result in chemical contact.

Maintain consistent application rates by inspecting the Solution Line Strainer (located beneath right-hand side of machine) daily for blockage. Clean the strainer screen as needed and ensure the gasket is in place before reinstalling the screen.

NOTE: Wear appropriate clothing while removing and cleaning the strainer screen.

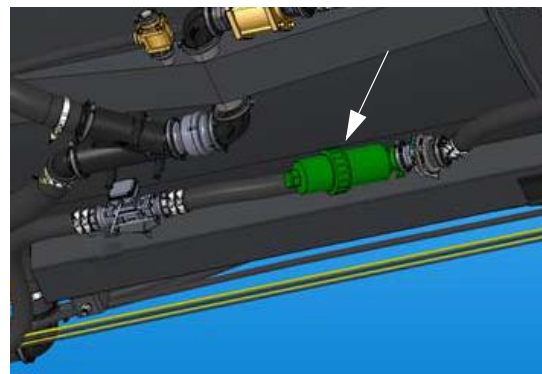

Solution Line Strainer
(Located beneath
right-hand side of machine)
-Typical View

Rinse Tank Strainer

- If Equipped

If your machine is equipped with a foam marker system, it will have a mesh Rinse Tank Strainer (located near the rinse tank outlet). Inspect the strainer for blockage if you are unable to obtain adequate pressure.

Cab Filters

RESPA® Cab Filter

NOTE: Replace the RESPA Cab Filter every 1,000 of operation or when cab pressure drops below the minimum pressure threshold (when cab is sealed), whichever occurs first.

Replacing the RESPA Cab Filter:

⚠ CAUTION

Do not clean or reuse filters. Failure to comply may create health hazards.

NOTICE

Replace filter in a clean and covered area to reduce operator and HVAC exposure to harmful particulates.

NOTICE

Ensure engine is turned OFF before servicing the RESPA Cab Filtration System.

NOTICE

When cleaning your machine, care should be taken to prevent high-pressure water or air from entering the RESPA Filtration System ejection slots. When replacing the slotted filter, do not point ejection slots at a solid surface in close proximity to the slots.

NOTE: Wear Personal Protective Equipment (PPE) when servicing the RESPA Cab Filtration System.

1. Turn engine OFF.

2. Inspect RESPA Cab Filtration System for damage.
3. Release the four (4) Filter Latches (located on the exterior filter housing).

NOTE: Note orientation of the ejection ports.



Filter Latches
-Typical View

4. Remove filter.

NOTE: When removing filter, place thumbs on exterior filter housing hardware for additional leverage.



Filter Removal
-Typical View

5. Place used filter in a sealed plastic bag and dispose.

NOTE: Dispose of filter according to local regulations.

6. Wipe off any loose debris around the filter housing using a clean cloth.

NOTE: DO NOT use compressed air to clean the filter housing.

7. Before installing the new filter, inspect the RESPA Cab Filtration System and replacement filter for proper operation.
8. Turn RESPA Filtration System ON, staying clear of the open end of the filter housing.
9. Ensure adequate airflow is blowing out of the empty filter housing.
10. Turn RESPA Filtration System OFF.
11. Install new filter.

NOTE: Ensure new filter ejection port orientation is correct and the filter end cap is properly seated on the filter housing (with the gills pointing downward to avoid water from entering in).

12. Re-latch the four (4) Filter Latches.

Refer to your Parts Manual for replacement part number.

Charcoal Filter

To access the Charcoal Filter:

- Remove the exterior service panel (located on right-hand side of cab).

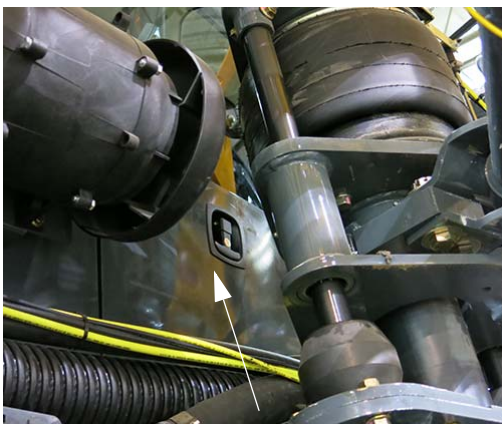

Exterior Service Panel
(Located on right-hand side of cab)
-Typical View

- Remove the charcoal filter access panel (located behind the exterior service panel).

NOTE: A recirculation filter is attached to the back side of the charcoal filter access panel.



Charcoal Filter Access Panel
(Located behind exterior service panel on right-hand side of cab)
-Typical View

- Slide Charcoal Filter out.



Charcoal Filter
-Typical View

Replacing the Charcoal Filter:

- Remove and replace Charcoal Filter at the first sign of chemical odor entering the cab area.

Refer to your Parts Manual for replacement part number.

Cleaning the Recirculation Filter:

- Remove Recirculation Filter and clean with soap and warm water (wring out gently) every 100 hours of operation.

SERVICE - LUBRICATION

NOTICE

Failure to properly lubricate pivot and friction points may result in unnecessary wear and damage.

Legs and Steering

Tie Rod Ball (front legs)

- Lubricate every 25 hours of operation, or as needed.



Tie Rod Ball Grease Zerk
(Located on the front legs)
-Typical View

All-Wheel Steer (AWS) ^

- If Equipped

If your machine is equipped with AWS, the steering cylinders on the rear legs also have grease zerks in the tie rod ends that require lubrication.

Tower Bearing (front and rear legs)

- Lubricate daily, or as needed.



Tower Bearing Grease Zerk
(Located on the front and rear legs)
-Typical View

Collar (air bag mounting plate)

- Lubricate every 50 hours of operation, or as needed.

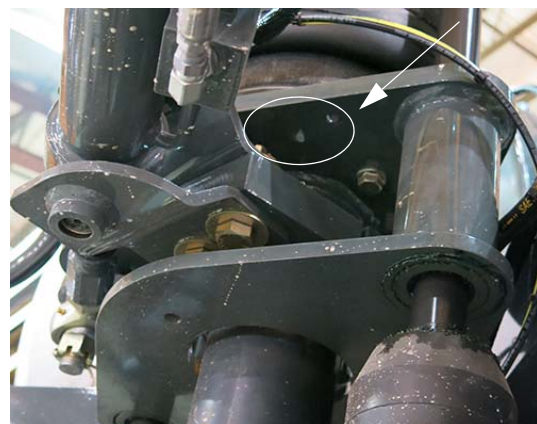

Collar Grease Zerk
(Located beneath each
air bag mounting plate)
-Typical View

Leg Tubes (front and rear legs)

NOTE: Initial greasing should fill the grease space until grease escapes the Pressure Relief Valve (between 40-80 psi/2.8-5.5 bar).

- Lubricate the legs weekly. When grease escapes the Pressure Relief Valve, the proper grease level has been reached.



• Pressure Relief Valve
• Leg Tube Grease Zerk

Leg Tube Grease Zerk and Pressure Relief Valve
(Located on front and rear legs)
-Typical View



Transom Pivot Tube
-Typical View

Ladder Pivot Tube

Lubricate the grease zerk (located on the back side of the Ladder Pivot Tube) every 50 hours of operation, or as required.

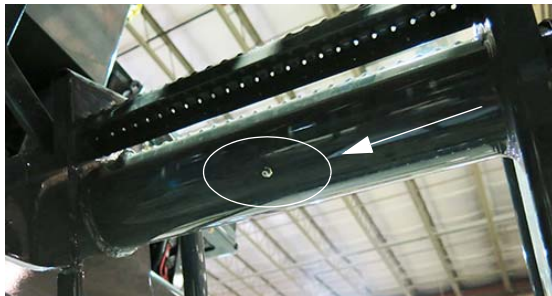

Ladder Pivot Tube
-Typical View

Boom Fold

Lubricate the Boom Fold (where the main boom section connects to the boom extension) daily, or as needed.



Boom Fold
-Typical View

90/100' Booms

Transom Pivot Tubes

Lubricate the grease zerk on the Transom Pivot Tube - one on each side (that attaches the boom to the transom) every 50 hours of operation, or as needed.

Boom Breakaway

Lubricate the grease zerk on the Boom Breakaway daily, or as needed.



Boom Breakaway
-Typical View

Boom Breakaway Cylinder Rod End

NOTICE
<p>Failure to lubricate the boom breakaway cylinder rod end grease zerks will result in damage to the breakaway cylinder and mounting if contact is made with an object.</p>

Lubricate the grease zerk on the Boom Breakaway Cylinder Rod Ends daily, or as needed.



Boom Breakaway Cylinder Rod End
-Typical View

120/132' Booms

Pendulum

Lubricate the grease zerk on each Pendulum weekly, or as needed.



Pendulum
-Typical View

Roller Mount Assembly

Lubricate the three (3) bearings on each Roller Mount Assembly daily, or as needed.

NOTE: Failure to keep the rollers properly lubricated may result in roller seizure.



Roller Mount Assembly
-Typical View



Pivot Transom Ball Joints
-Typical View

Pivot Transom

Lubricate the four (4) Pivot Transom grease zerks (located at the top and bottom of each Pivot Transom) every 50 hours of operation, or as needed.

Boom Adapter

Lubricate the two (2) grease zerks on each Boom Adapter every 25 hours of operation, or as needed.

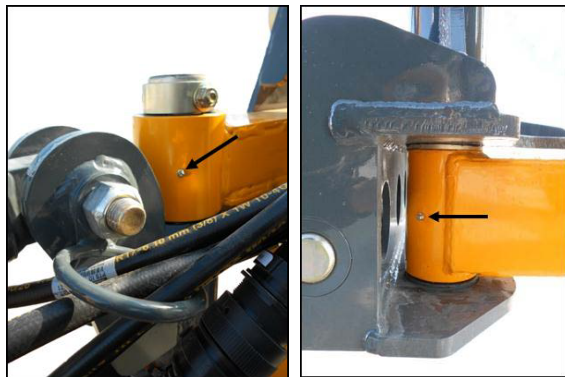

Pivot Transom
-Typical View



Boom Adapter
-Typical View

Pivot Transom Ball Joints

Lubricate the two (2) Pivot Transom Ball Joint grease zerks (located on the left and right-hand side of the Pivot Transom) every 25 hours of operation, or as needed.

Boom Fold Linkages

Lubricate the grease zerks on the Boom Fold Linkages every 50 hours of operation, or as needed.



Boom Fold Linkages
-Typical View



Quad Puller Head
-Typical View

Outrigger Fold (Left and Right)

- Lubricate each left and right Outrigger Fold grease zerk (2) a minimum of every 50 hours of operation, or as needed.

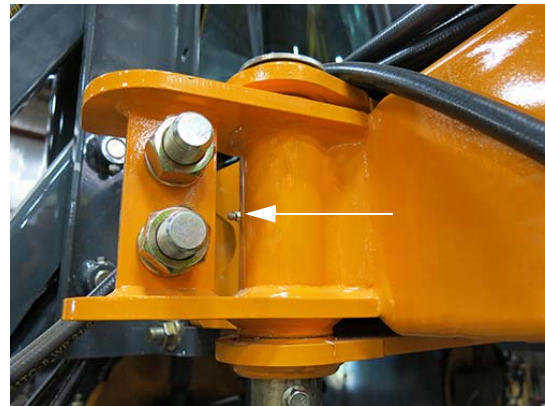

Outrigger Fold
-Typical View

Detasseler Combo

Quad Puller Heads

- Lubricate each Quad Puller Head grease zerk (4 - two each side) twice per day (morning and noon suggested).

Lift Arm Assemblies

- Lubricate each Lift Arm Assembly grease zerk (6) a minimum of every 50 hours of operation, or as needed.

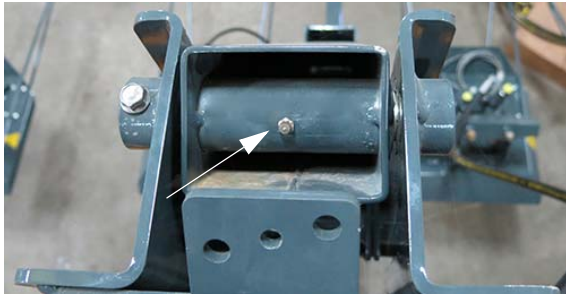

Lift Arm Assembly - Top
-Typical View



Lift Arm Assembly - Mid
-Typical View

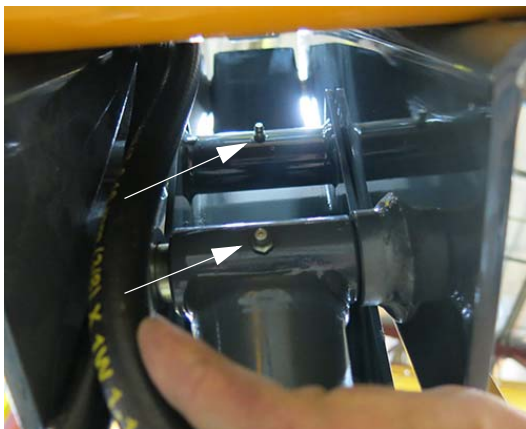

Lift Arm Assembly - Inner Arm
-Typical View

NOTE: An additional grease zerk is located inside of the lower lift arm frame.

SERVICE - ENGINE DRIVE BELT

Removal

- Insert a 1/2" square ratchet drive into the belt tensioner. See following illustration.

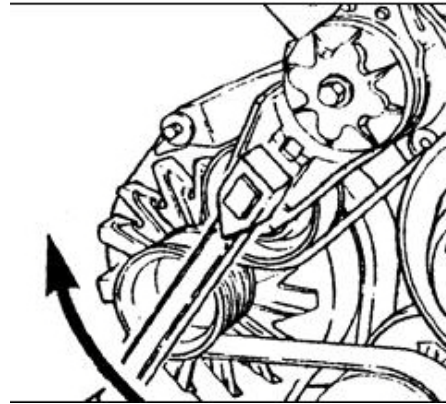

-Typical View

- Lift UP and remove Engine Drive Belt.

Inspection

- Visually inspect the Engine Drive Belt daily.
- Check the belt for intersecting cracks. See following illustration.

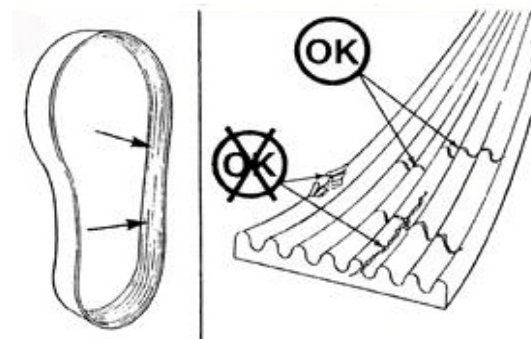

-Typical View

NOTE: Transverse cracks (across the belt width) are acceptable. Longitudinal cracks (direction of the belt length) that intersect with transverse cracks are not acceptable.

- Replace the Engine Drive Belt if it is frayed or has material missing.

SERVICE - BOLT TORQUE

NOTICE

Check lug nut torque immediately after receiving the machine and every 50 hours of operation thereafter.

Wheel Bolts

NOTE: If you do not have the proper equipment to mount a tire, contact a local qualified tire service center.

The tire should be mounted on the rim (as shown in the following illustration) for optimal traction and tread cleaning action.



To install wheel/tire assembly onto the wheel hub:

1. Ensure threads are thoroughly cleaned of rust and dirt.

NOTE: Threads should be dry (no lubricant).

2. Align the wheel bolt holes with the wheel hub studs.
3. Mount wheel on the hub.
4. Start all of the lug nuts and tighten until snug.
5. Following the torque sequence (as shown the following illustration), turn each lug nut to a torque value of 120 dry ft.-lbs.

NOTE: Use slow, even pressure on the torque wrench. Quick or jerky movements can cause inaccurate values.

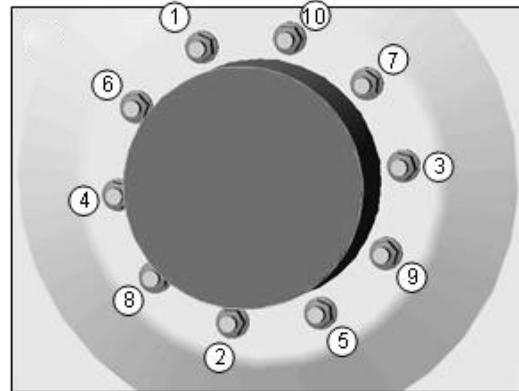

Torque Sequence

6. Repeat the same sequence to 150 dry ft.-lbs. and again to 400-500 dry ft.-lbs.

NOTE: If the wheel turns during lug nut torquing, lower machine to the ground - just enough for the tire to touch and prevent rotation. Or, more preferably, place a suitable wedge between the tire and the ground. Lower the machine and resume operation. Recheck torque after 30 minutes of operation.

7. When torquing is complete, lubricate exposed threads with anti-seize compound.

Hydraulic Tread Adjust Machines -If Equipped

With the engine turned OFF, visually inspect the tread bearing bolts on both the bottom and side tread adjust bearing plates every 50 hours of operation. Inspect the torque every 100 hours of operation.

To check torque of the tread adjust bearing bolts:

1. Loosen the jam nut on each tread adjust bearing bolt.



Jam Nut
(Located on each tread adjust bearing bolt)
-Typical View

- Using an “X” pattern (as shown in the following photo), verify that the current torque on each tread adjust bearing bolt is equivalent to the last inspection from 100 hours of previous operation.

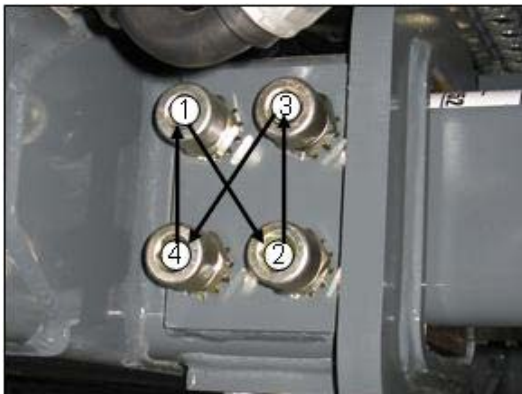

“X” Pattern
-Typical View

- Repeat pattern 3 to 4 times until the last sequence shows no movement of the bolts to achieve desired torque.
- Tighten jam nut.

Typically, a torque value of 20 to 25 ft.-lbs. is required to stabilize the axle and still allow tread width adjustment.

NOTE: Never operate machine with loose or missing tread plates. To visually inspect for loose tread plates, slowly rock the machine forward and backwards while observing the legs

for movement. If plates become loose, the leg will rock as the machine starts to move.

NOTICE

If hydraulic tread adjust will never be used or if your machine is not equipped with tread adjust, set all bolt torque settings to 50 ft.-lbs. using the following procedure.

EVEN PRESSURE OF THE TREAD ADJUST BEARING PLATES IS REQUIRED FOR PROPER OPERATION.

- Figure A** - shows correct position of the tread adjust bearing plates and bolts, as well as the outer leg.
- Figure B** - shows the plates when there is not even torque on each of the tread adjust bearing bolts.
- Figure C** - shows a situation in which there is not enough torque on the tread adjust bearing bolts.

NOTE: Both Figures B and C will cause the tread adjust to operate incorrectly, or not at all.

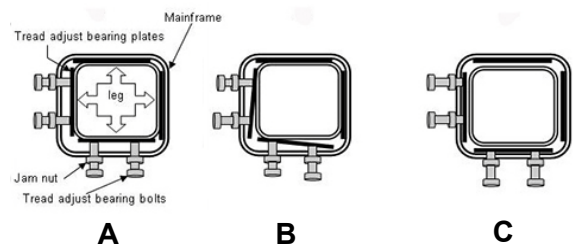

SERVICE - TOE-IN

Step 1 - Phase Steering Cylinders

The steering cylinders must be phased before any mechanical adjustments can be made (cylinder stroke = 8.8”/22.4 cm). When

the cylinders are re-phased, each cylinder should reach mid-stroke (4.4"/11.2 cm). Once both cylinders are at 4.4"/11.2 cm, Toe-In can be set.

To Phase the Steering Cylinders

1. Start the machine.
2. Turn steering wheel to the right or left.
3. When the wheels stop turning, continue to turn the steering wheel 3 to 4 full revolutions (this will put the cylinders back in phase with each other).

Step 2 - Set Toe-In

Front Wheels

- .25" (.6 cm) Toe-In per side/0.5" (1.3 cm) total Toe-In

Rear Wheels

- 0" (0 cm) Toe-In/Out

NOTE: Initial wheel alignment should be performed with steering cylinders "unpinned" from the leg.

To Set Toe-In

1. Deflate the air bags.

NOTE: Refer to "Air Suspension Exhaust" provided in the Miscellaneous Section elsewhere in this manual for further information.

2. Measure the distance from the ground to center of wheel hub.

NOTE: All four wheel hubs should measure the same distance.

3. Mark this distance on the inner edge of the wheel rim (front and back of each rim - 8 marks total).

NOTE: All measurements will be taken from these markings.

4. Visually align the tires from front to rear.

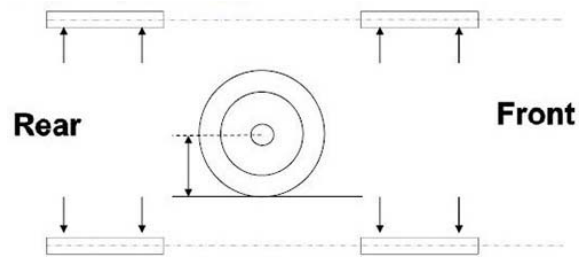

Front Wheels

5. Measure the width between the front wheels (front W1, rear W2) at the wheel hub center line and record measurements.
6. Adjust the wheels until the front and rear measurements are equal ($W1=W2$).
7. Measure diagonally (D1 and D2) and record the measurements.
8. Adjust the wheels until the measurements are equal.

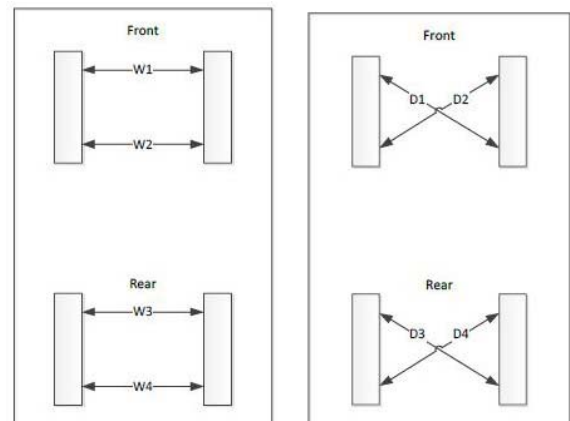

9. Continue to cycle between Steps 5-6 and 7-8 until the width measurements match and the diagonal measurements match. Then and only then are the wheels parallel to each other and the frame.

NOTE: To achieve this, both conditions must be met.

NOTE: The front steering cylinders must both be centered before proceeding!

10. Set both cylinders to center by measuring 7.64" (19.4 cm) (as shown in the following photo).

The position sensors should both read

4.4” (11.2 cm) when the cylinders are centered and in phase.

This is not required for All-Wheel Steer (AWS) machines, as the cylinder position sensors can be used to center the cylinders.

- *The cylinder sensors must be calibrated for this position to be accurate.*
- *If the cylinders do not center at this measurement, they are not in phase. To re-phase the cylinders, turn the steering wheel so that one cylinder is fully retracted and the other is fully extended. Turn the steering wheel at least one full turn past this point. Re-center the cylinders. If the measurements still do not match, repeat the cylinder air bleed procedure.*

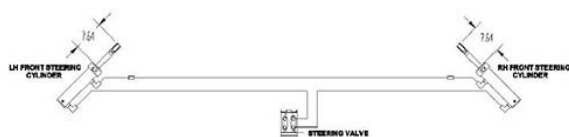

11. With the cylinders centered, adjust the tie-rods (located on the cylinder rods) until they line up with the bolt-down hole (located on the lower air bag plate).
12. Turn the tie-rod one more full turn to achieve desired amount of toe-in.
 - *When the rod ends are turned the final turn (to establish the desired amount of toe-in), the rod ends turn in opposite directions to get each wheel in toe.*
 - *If the amount of threads showing on the left and right rod ends differ by more than four (4) threads, repeat previous Steps 1-12. If the difference remains, there may be a tolerance issue in the leg assembly.*
13. Pry wheel in to allow rod end securing bolt to be inserted.

14. Insert the bolt and secure main bolt and cylinder jam nut to the proper torque specification.

Rear Wheels

NOTE: Rear wheels should be set to 0.0” (0.0 cm) toe in/out.

15. Repeat previous Steps 1-9.
16. **(Non-AWS Machines)** - Set tie rod assembly to match up with the bolt-down hole (located on the lower air bag plate). Insert bolt and secure to the proper torque specification.
17. **(AWS Machines)** - Repeat Step 10, centering the rear cylinders at 4.4” (11.2 cm). Insert bolt and secure main bolt and cylinder jam nut to the proper torque specification.

NOTE: The cylinder sensors must be calibrated for this position to be accurate.

- *The machine should be driven and toe (front and rear) rechecked.*
- *Front steering cylinders must be in phase when toe setting is checked.*
- *Failure to hold toe setting could indicate the presence of air in the cylinders.*
- *Repeat the cylinder bleeding procedure, if necessary.*

Further Information

Contact Hagie Customer Support if additional assistance is needed.

SERVICE - MISCELLANEOUS

Air Bags

The Air Bags (one located on each leg) automatically adjust pressure to compensate for load weight and field conditions.

Contact Hagie Customer Support if assistance is needed.

Air Tank

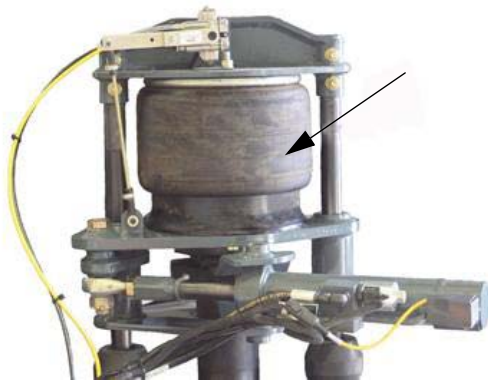

Air Bag
(Located on each leg)
-Typical View

The system includes an Air Dryer (located beneath the right-hand side of machine) that dries air coming from the air compressor before sending it to a collection tank.

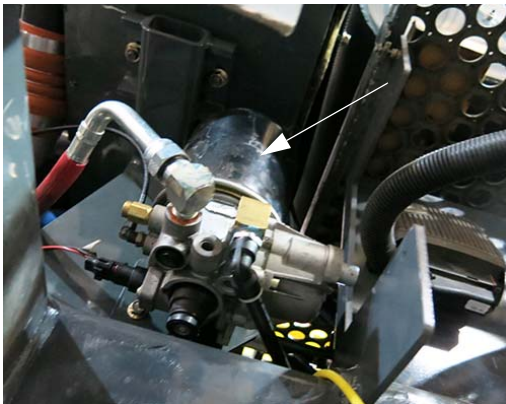

Air Dryer
(Located beneath the
right-hand side of machine)
-Typical View

From the collection tank, air is sent to the Air Bags as needed to maintain a level pressure. Control valves open and close to allow air in.

- Inspect the Air Dryer cartridge every 50 hours of operation to ensure that it is purging with compressor load. Change the cartridge every 1,000 hours of operation, or as needed.
- Inspect Air Bags daily for leaks and/or cracking. If an Air Bag is low, check the bag for any punctures or leaks.



- Drain the Air Tank daily by slowly releasing the Tank Drain Valve (located beneath platform on left-hand side of machine).

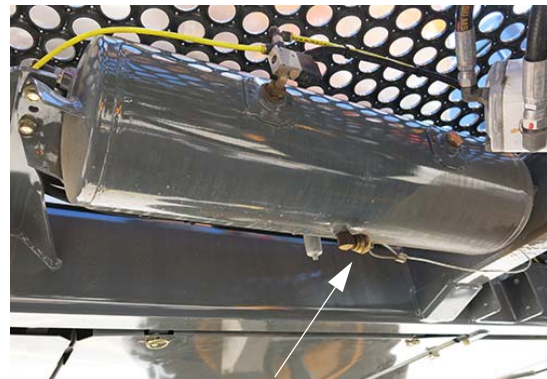

Tank Drain Valve
(Located beneath platform
on left-hand side of machine)
** Pull DOWN to open*
-Typical View

- Check for moisture. If excessive moisture is in the tank, there may be a system malfunction.

Contact Hagie Customer Support if assistance is needed.

Tire Pressure

 **CAUTION**

When inflating tire, use an extension with an in-line air gauge and attach air chuck. This will allow the operator to stand clear of tire sidewall explosion trajectory.

- Check tire pressure weekly.
- Never inflate a tire more than the recommended maximum air pressure.
- Use an airline with a locking air chuck and stand behind the tire tread while filling.



-Typical View

NOTE: Tire pressure will depend on type of tire used and amount of load.

Tall Corn Machines

-If Equipped

If your machine is equipped with the Tall Corn option, perform the following steps to access the tire valve stem:

1. Using a 5/32" hex wrench, remove the button-head screw (located on the wheel access panel) and set aside.
2. Using a 7/16" socket wrench, loosen the hex bolt (located on the wheel access panel) and allow panel to hang loose.

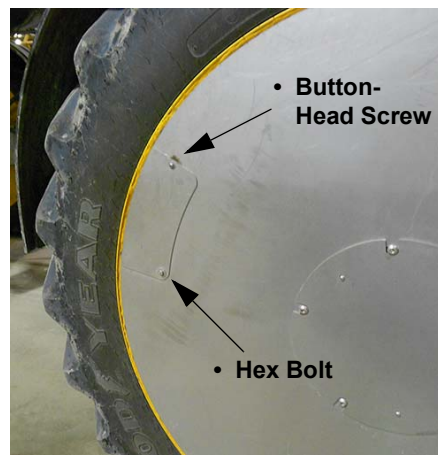

-Typical View



-Typical View

3. Check tire pressure and inflate as desired.
4. Reverse steps to reinstall wheel access panel.

Spray Booms

Nozzle Diaphragms

At the beginning of each season, remove each nozzle body cap (A) and inspect the diaphragm (B) for wear or fit. Replace diaphragms every 1,000 hours of operation, or as necessary.

Spray Tips

CAUTION

Never place a spray tip/nozzle to your mouth in an attempt to unplug it.

At the beginning of each season (or as required), remove a random sample of spray tip caps (C) and inspect the nozzle tips. If the tips are plugged or worn, clean or replace them. Replace spray tips every 1,000 hours of operation, or as necessary.

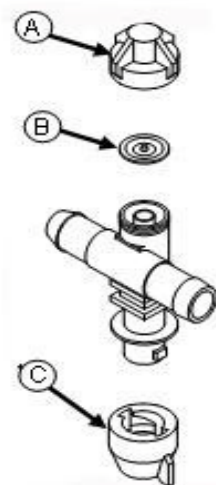

Nozzle Diaphragms and Spray Tips
-Typical View

NORAC® Sensor Foam Pads

Inspect the NORAC Sensor Foam Pads daily. Remove the foam pad from each sensor, blow out with compressed air, and reinstall.

NOTE: Ensure foam pads are clean and dry to ensure optimal performance.

NOTE: DO NOT blow the foam pad out while still installed on the sensor. Always remove foam pad before cleaning to avoid sensor damage.



NORAC Sensor Foam Pad
(Located on the bottom of each sensor)
-Typical View

Replace foam pads as necessary. Contact Hagie Customer Support for replacement.

Wiper Blade

NOTICE

Use a sturdy stationary ladder to safely access the wiper blade.

Do not allow the Wiper Blade to run on a dry windshield, as this will shorten the life of the blade and/or cause scratching on the windshield.

NOTE: Replace the windshield wiper blade (39"/99 cm) as necessary.

The Windshield Washer Fluid Spray Nozzle is adjustable. The fluid spray pattern should be inspected at the beginning of each season, and adjusted as necessary.



Windshield Washer Fluid Spray Nozzle
(Located near top of exterior cab)
-Typical View

Washing the Machine

Wash the machine daily to remove any harmful chemical residue, which can be corrosive to paint and steel.

NOTE: Always wash machine thoroughly after applying liquid nitrogen.

As often as possible, thoroughly wash the machine and apply paint to any place where the paint is light or missing.

For replacement decals or touch-up paint recommendations, contact the Hage Customer Support department.



SERVICE INTERVALS

Service Point	Initial	Daily/ Before Each Use	As Required	50 Hrs.	100 Hrs.	250 Hrs. **	500 Hrs. **	1000 Hrs.
Check Lug Nut Torque (Break-in)	X							
Check Engine Oil Level		X						
Check Radiator Coolant Level		X						
Check Radiator Grille Screen		X						
Check Engine Drive Belt		X						
Check A/C Compressor Belt		X						
Check Hydraulic Reservoir Level		X						
Check Solution Line Strainer		X						
Check Batteries		X						
Check for Leaks Around the Machine		X						
Drain Air Tank		X						
Check Windshield Washer Fluid Level		X						
Wash Machine Clean of Chemical Residues		X						
Check and Drain Primary Fuel Filter (Water Separator)		X						
Check Air Bags		X						
Check Engine Air Intake Piping		X						
Lubricate Boom Fold Grease Zerks (90/100')		X						
Lubricate Boom Breakaway Grease Zerks (90/100')		X						
Lubricate Boom Breakaway Cylinder Rod End Grease Zerks (90/100')		X						
Check Quad Puller Tire Pressure		X						
Check/Tighten Cutter Blade Retaining Bolts		X						

SECTION 9 –
MAINTENANCE AND STORAGE



Service Point	Initial	Daily/ Before Each Use	As Required	50 Hrs.	100 Hrs.	250 Hrs. **	500 Hrs. **	1000 Hrs.
Lubricate Quad Puller Head Grease Zerks		X						
Check Aftertreatment DEF Tank Level (Tier 4 Final Engines)		X						
Check Aftertreatment DEF Exhaust Piping (Tier 4 Final Engines)		X						
Lubricate Leg Grease Zerks			X					
Replace Windshield Wiper Blade			X					
Fill Windshield Washer Fluid Reservoir			X					
Clean Radiator Grille Screen			X					
Change Engine Drive Belt			X					
Change A/C Compressor Belt			X					
Charge A/C Compressor *			X					
Change Air Intake Filter (Filter Minder)			X					
Clean/Replace Solution Line Strainer			X					
Check Spray Nozzle Diaphragms and Tips			X					
Change Tread Adjustment Bearing Torque			X					
Change Batteries			X					
Change or Replace Fuses and Breakers			X					
Replace Charcoal Cab Filter			X					
Check Tire Pressure			X					
Clean/Replace Rinse Tank Strainer (if equipped)			X					
Inspect/Replace Tank Rinse Strainer (Main Tank)			X					
Lubricate Air Bag Collar Grease Zerk				X				
Check Lug Nut Torque				X				



SECTION 9 –
MAINTENANCE AND STORAGE

Service Point	Initial	Daily/ Before Each Use	As Required	50 Hrs.	100 Hrs.	250 Hrs. **	500 Hrs. **	1000 Hrs.
Lubricate Ladder Pivot Tube Grease Zerk				X				
Change Wheel Hub Oil (Break-in)				X				
Check Air Dryer Cartridge				X				
Check Tread Adjust Bearing Bolts (Visually)				X				
Lubricate Boom Transom Pivot Tube Grease Zerks (90/100')				X				
Lubricate Outrigger Fold Grease Zerks				X				
Lubricate Lift Arm Assembly Grease Zerks				X				
Check Wheel Hub Oil Level					X			
Clean Batteries					X			
Check Tread Adjust Bearing Bolt Torque					X			
Clean Cab Recirculation Filter					X			
Change Wheel Hub Oil						X		
Change Engine Oil							X	
Change Engine Oil Filter							X	
Change Primary Fuel Filter (Water Separator)							X	
Change Secondary Fuel Filter							X	
Change Hydraulic Return Filter							X	
Change Hydraulic Pressure Filter							X	
Change Hydraulic Charge Pump Filter							X	
Change Hydraulic Case Drain Filter							X	
Change Hydraulic Breather Cap							X	

SECTION 9 –
MAINTENANCE AND STORAGE



Service Point	Initial	Daily/ Before Each Use	As Required	50 Hrs.	100 Hrs.	250 Hrs. **	500 Hrs. **	1000 Hrs.
Check Radiator Coolant Concentration							X	
Change Hydraulic Reservoir Oil								X
Replace RESPA® Cab Filter								X
Change Radiator Coolant								X
Change Air Dryer Cartridge								X
Change Spray Nozzle Diaphragms and Tips								X
Exhaust Brake Service (contact engine manufacturer)								X

* Use proper equipment.

** 250-500 hours or yearly, whichever occurs first.

NOTE: Tier 4 Final Engines - Replace Aftertreatment Diesel Exhaust Fluid (DEF) Supply Module Filter every 4,500 hours of operation. Refer to the engine manufacturer's operation manual for further information.

Inspection Point	Action (if necessary)
Engine Oil Level	Add Oil
Radiator Coolant Level	Add Antifreeze Solution
Engine Drive Belt	Replace Belt
Filter Minder	Replace Air Filter Element
Hydraulic Reservoir Oil Level	Add Hydraulic Oil/Repair Leaks
Solution Line Strainer	Remove and Clean
Batteries	Clean and/or Tighten
Radiator Grille Screen	Clean
Look for Loose or Missing Items (e.g. shields)	Tighten or Replace
Look for any Fluid Leaks on Machine or Ground	Determine Cause and Correct
Fuel/Water Separator (Drain)	See "Service: Filters" elsewhere in this section
Air Tank (Drain)	See "Service: Miscellaneous" elsewhere in this section

120/132' Spray Boom Service Intervals			
Service Point	Daily/Before Each Use	Weekly	As Required
Lubricate Roller Mount Assembly Grease Zerks	X		
Inspect/Clean NORAC® Sensor Foam Pads	X		
Lubricate Pendulum Grease Zerks	X		
Lubricate Level Pin Adapter Plate Grease Zerks		X	
Replace NORAC Sensor Foam Pads			X
Lubricate Pivot Transom Grease Zerks			X
Lubricate Pivot Transom Ball Joints			X
Lubricate Boom Adapter Grease Zerks			X
Lubricate Boom Fold Linkage Grease Zerks			X
Check Spray Nozzle Diaphragms and Tips			X

STORAGE

Preparing For Storage

1. Perform daily level checks, lubrication, and bolt/linkage inspections, as required in this manual.
2. Every other season, drain the coolant from the engine and radiator. Probe the drain holes during drainage to ensure they are not clogged by sludge, scale, or other deposits.
Fill the cooling system to the top with a 50/50 water/antifreeze mixture. Run the engine to operating temperature and recheck level.
3. Add a fuel stabilizer to the fuel and fill the tank.
4. Run the engine until it reaches operating temperature, then drain the engine oil. Refill with fresh oil of recommended weight and install a new lubricating oil filter element.
5. With the engine at normal operating temperature, cycle all hydraulic functions, including the steering.
6. Release tension on all belts.

7. Use plastic bags and water-resistant adhesive tape to seal the air intake opening, all exhaust manifold openings, engine oil fill cap, hydraulic oil tank breather cap, and fuel tank caps.

NOTE: If the spray boom will be stored separately from the machine, ensure all boom hole openings are capped or covered with a suitable covering.

8. Tier 4 Final Engines - Plug the Diesel Exhaust Fluid (DEF) tank venting to seal tank exposure against environmental elements.
9. Disconnect and remove batteries. Completely clean and charge the batteries. Coat the terminals with dielectric grease and store the batteries in a cool place (above freezing).
10. Thoroughly wash the machine and its attachments. Touch up any painted surfaces that are scratched or chipped.

NOTE: For paint touch-up recommendations, contact the Hagie Customer Support department.

11. Replace worn or missing decals. Refer to “Safety Decals” in the *Safety and Pre-*

cautions Section for proper location of warning decals and corresponding part number.

NOTE: For decal replacement, contact the Hagie Customer Support department.

12. Apply multi-purpose grease to coat exposed hydraulic cylinder rods.
13. Refer to the Spray System Console manufacturer's operation manual for detailed information on storage procedures for the console and flow meters.
14. If the machine must be stored outside, cover with a waterproof cover.

Winterization

To winterize the spray system, it is recommended that you use an environmentally safe type of antifreeze and water mixture that will give you adequate protection to -30 degrees F.

- Drain any remaining solution in the spray system.
- Thoroughly rinse the spray system.
- Run antifreeze/water mixture through the spray system until it comes out all of the boom openings.

NOTE: Ensure the Agitation Valve Switch (located on the side console) is in the OPEN position before running antifreeze/water mixture through the system.

Repeat process for both the Foam Marker and Rinse Systems.

Removing From Storage

NOTICE

Protective compounds such as grease can harden under exposure to weather conditions. Be sure to remove any dried grease and reapply new, if necessary.

1. Inspect the condition of and test the air pressure of all tires.

2. Carefully unseal all openings that were previously sealed in the "Preparing for Storage" process.
3. Clean and reinstall the batteries. Be sure to attach the battery cables to the proper terminals.
4. Tighten all belts. Inspect and replace any worn belts.
5. Check the engine oil, hydraulic oil, and engine coolant levels, and add if necessary.

NOTE: A mixture of 50/50 water/antifreeze will cool adequately in the summer, as well as protect in winter.

6. Thoroughly clean the machine and it's attachments.
7. Perform all recommended services as instructed elsewhere in this section.
8. Attach the spray boom and manually cycle all of the hydraulic functions 2 or 3 times to thoroughly lubricate the components. Test the NORAC® system and all of it's functions according to the manufacturer's operation manual.
9. Reset date and time on Machine Display.
10. For starting instructions, refer to "Engine - Starting" provided in the *Engine and Drive Systems Section* elsewhere in this manual.

SECTION 10 – MISCELLANEOUS

TRANSPORTING

When driving on a public roadway or elsewhere, be aware of any situation where the machine will be passing under an object with a clearance lower than the transporting height of the machine.

CAUTION

Hagie Manufacturing Company does not recommend any form of transportation other than driving the sprayer. Loading the sprayer onto a trailer may result in sprayer rollover.

WARNING

- Never operate the sprayer on a public roadway with solution in the tank.
- Never load or unload the sprayer with solution in the tank.
- Stopping the sprayer on trailer ramps may result in the sprayer to tip over.

CAUTION

Do not operate the machine at speeds exceeding 20 mph (32 km/h) with solution in the tank. Operating speeds exceeding 20 mph (32 km/h) with a fully loaded tank may result in tire blow-out or wheel hub damage and will void the warranty.

WARNING

When transporting the sprayer, observe the following to avoid serious injury or death:

- Check for adequate clearance before driving under any overhead obstructions.
- Contact with power lines may result in serious injury or death.



CAUTION

Do not transport the machine without the booms folded and in cradle. Failure to comply may result in injury or equipment damage.

Cradling the Booms

CAUTION

Booms must be in FOLDED position when cradled. Failure to comply will result in property damage.

NOTE: Always cradle the booms before traveling, transporting, or parking for an extended period of time.

- Fold the outer boom extensions IN.
- Raise the transom all the way UP.
- Fold main boom sections IN toward the machine.

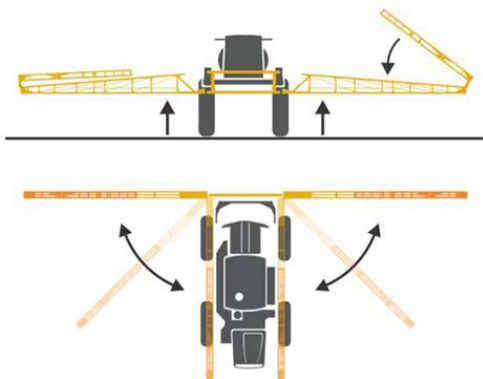

NOTE: If using Auto Fold (120/132' booms), when boom reaches the last 8-10 degrees of travel, it will automatically slow down to avoid impact with the cradle.

- Raise each individual boom until it clears the outer cradle stop.
- Fold the boom IN toward cradle back-stop.



- When boom touches the back-stop, lower until the full weight of the boom rests in the cradle.



Folding the Outriggers

NOTE: If your combo attachment is equipped with the 4-2 feature, refer to “4-2 Detasseler Combo Attachment - Adjustable” provided in the Detasseling Systems Section elsewhere in this manual for information on folding and sequence valve adjustments.

NOTICE

Stagger detasseling heads before folding the outriggers. Failure to comply will result in property damage.

Before folding the outriggers, the detasseling heads must be staggered in height. Damage will occur if detasseling heads are all the same height when the outriggers are folded.

To Stagger the Detasseling Heads

- Using the corresponding Lift Up/Down Switches (located on the Tasseltrol® Control Panel), stagger the detasseling heads.



Lift Up/Down Switches
(Located on the Tasseltrol Control Panel)
-Typical View

1. Lower the two center detasseling heads all the way DOWN.
2. Raise all the detasseling heads on one side to approximately half of the fully raised height.

3. Raise the detasseling heads on the opposite side to the fully raised height.



Staggered Detasseling Heads
-Typical View

To Fold the Outriggers

- Slowly fold the outriggers in by pressing and holding the corresponding Left/Right Fold Switches (located on the Detasseling Control Panel) in the UP (Fold) position, making adjustments (as necessary) to the height of the detasseling heads.



Left/Right Fold Switches
(Located on the Detasseling Control Panel)
-Typical View

NOTICE

Do not attempt to make any adjustments to the detasseling heads after the outriggers are folded. Failure to comply may cause the stalk guides or depth command sensor bars to entangle, resulting in equipment damage.

Driving the Sprayer on a Public Roadway

1. Always have the booms in the folded and cradled position when driving or transporting the machine.
2. Use the flashing hazard/warning lights, day or night to warn other drivers, unless prohibited by law.
3. Know and obey all state laws for driving agricultural equipment on a public roadway.
4. Adjust machine speed to suit the conditions.
5. Slow down and use turn signals before turning.
6. Pull over to the side of the road before stopping.
7. Keep a proper lookout and maintain control of the machine.
8. Do not drive under trees, bridges, wires, or other obstructions unless there is adequate clearance.
9. Use extra care before entering or exiting a public roadway.
10. Ensure the SMV (Slow Moving Vehicle) and SIS (Speed Indicator Symbol) emblems are properly displayed to warn other drivers, unless prohibited by law.
11. Do not drive the machine at speeds exceeding 20 mph (32 km/h) with solution in the tank. Operating speeds exceeding 20 mph (32 km/h) with a fully loaded tank may result in tire blow-out or wheel hub damage and will void the warranty.

Loading



Keep all persons away from trailer when loading or unloading the sprayer. Failure to comply may result in serious injury or death.

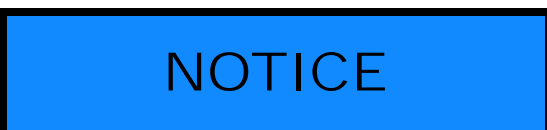

Read and understand the trailer manufacturer's operation manual. Hitch the trailer to the pulling vehicle according to their recommendations.

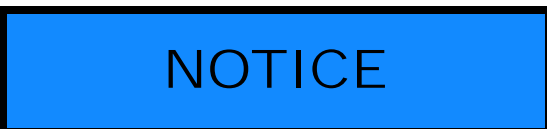

The loaded height and width of the trailer must conform to state law in which it is being used. Do not exceed the trailer manufacturer's recommendations on loaded weight.

1. Pull the trailer to flat ground.
2. Apply the pulling vehicle's parking brake and turn the engine OFF.
3. Use tire chocks to keep the trailer from moving.
4. Fold the booms and lower into cradles.
5. Lower the trailer ramps and set the ramp spacing for the machine's tread width setting.
6. Have an attendant help guide you onto the trailer.
7. Allow enough room between the sprayer and the pulling vehicle for turning.
8. Secure the sprayer onto the trailer using the recommended securement restraints (see trailer manufacturer's operation manual).

9. Cover or remove the SMV (Slow Moving Vehicle) and SIS (Speed Indicator Symbol) emblems when traveling over 35 mph (55 km/h).

Unloading

1. Pull the trailer to flat ground.
2. Apply the pulling vehicle's parking brake and turn the engine OFF.
3. Use tire chocks to keep the trailer from moving.
4. Lower the trailer ramps and set the ramp spacing for the machine's tread width setting.
5. Carefully release the securement restraints.
6. Have an attendant help guide you off of the trailer.
7. Uncover or replace the SMV and SIS emblems.

Towing

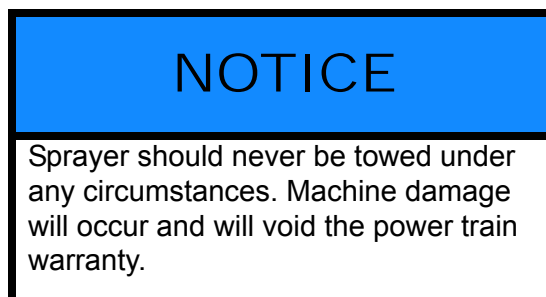

Contact Hagie Customer Support if towing is unavoidable.

LIFTING YOUR MACHINE



Do not lift machine by more than one or two lifting points at the same time. Failure to comply will cause the machine to become unable, resulting in serious injury or death.



Use extreme caution when supporting machine by a lifting point. Failure to obtain proper location and lifting equipment may cause the machine to become unstable, resulting in serious injury or death.



Lift machine on hard level surface with properly rated equipment only.



RISK OF INJURY DUE TO IMPROPER LIFTING.
DO NOT ATTEMPT TO LIFT MACHINE
WITHOUT JACKS PROPERLY SEATED IN THE
LIFTING POINT CONTAINMENT RINGS.

There are four (4) designated lifting points on the machine. These points are located on the frame near each leg and are equipped with containment rings for safe jack location.

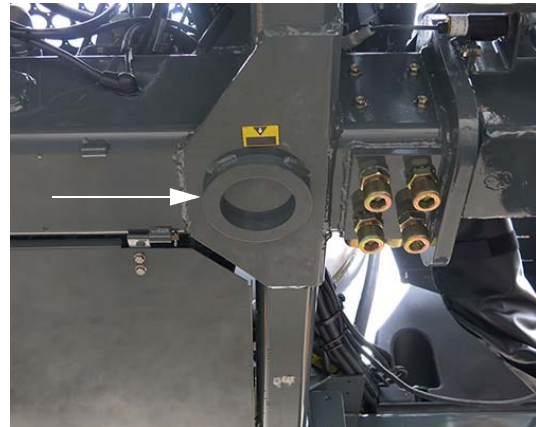

Lifting Point Containment Ring
(Located on the frame near each leg)
-Typical View

**To Lift Machine
(Bottle Jacks)**

1. Shut the engine off.

NOTE: The parking brake will engage automatically when the engine is shut off.

2. Place wood blocks in front and rear of the tires not being lifted.
3. Align jack with Lifting Point Containment Ring.

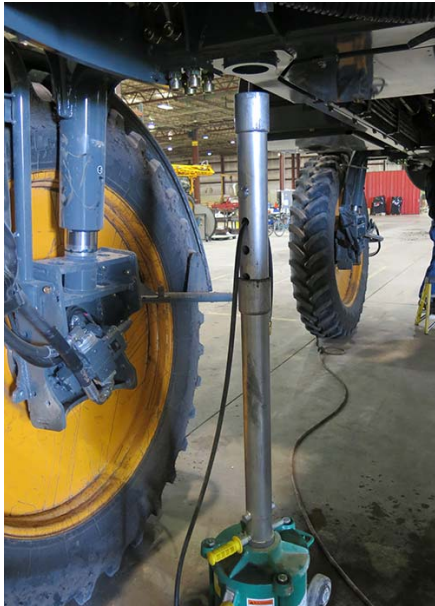

Align Jack with Lifting
Point Containment Ring
-Typical View

4. Connect air supply to jack.
5. Tap air supply handle and slowly insert jack into Lifting Point Containment Ring.



Insert Jack into Lifting
Point Containment Ring
-Typical View

6. Once jack is fully seated into the Lifting Point Containment Ring, continue to

press and hold air supply handle until the machine reaches desired height.

! WARNING

Ensure lock pins are fully inserted at base of jack. Do not rely on jack air supply to support a raised machine. Sudden loss of air pressure will cause the machine to become unstable, resulting in serious injury or death.

7. Install Lock Pins to the base of jack.



Lock Pin Installation
-Typical View

8. Reverse steps to lower machine.

QUICK-TACH SYSTEM -
SPRAY BOOMS

CAUTION

When operating or positioning the booms, observe the following safety precautions. Failure to comply may result in injury or equipment damage.

- Do not unfold/fold boom extensions when main boom is in cradle.
- Do not operate machine with one boom out of cradle and the other boom in cradle.
- Ensure booms are folded and in cradle before transporting the machine.

WARNING

When connecting or disconnecting the booms, observe the following safety precautions:

- Monitor both sides of the boom during fold procedure.
- Select a safe area that is solid and level before unfolding/folding the booms.
- Clear area of personnel.
- Check for overhead obstructions.
- Do not unfold or fold booms near power lines. Contact with power lines can result in serious injury or death.



WARNING

Turn the engine OFF before connecting/disconnecting any hoses or electrical lines. Failure to comply may result in serious injury or death.

Connecting the Boom

1. Square up to the boom.

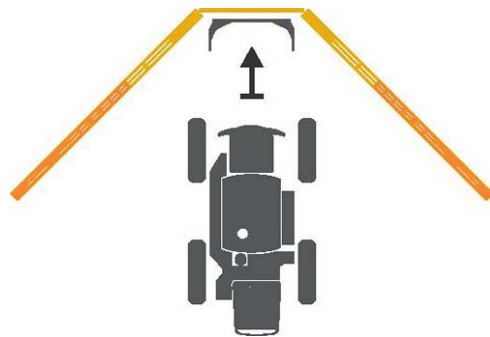

2. Disengage the Quick-Tach Lock Assemblies by pulling the Lock Pins (located on the front left and right-hand side of machine) OUT as far as it will go until it is in the “lock-out” position.

NOTE: “Lock-out” position prevents re-locking while attaching or detaching the attachment.

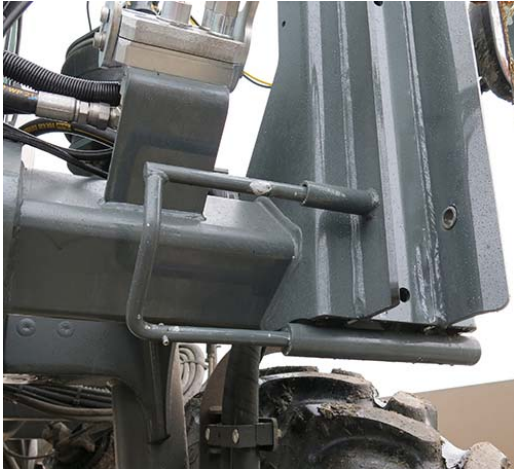

Lock Pin
(Located on the front left and
right-hand side of machine)
-Typical View
** Disengaged position shown*

3. Slowly pull into the attachment.
4. Ensure the Attachment Hooks are high enough to clear the Mounting Pins.



Attachment Clearing Mounting Pin
-Typical View

5. If necessary, lower the machine by rotating the corresponding Air Suspension Valves (located on the left-hand front air bag) in the COUNTER-CLOCKWISE (Deflate) position.

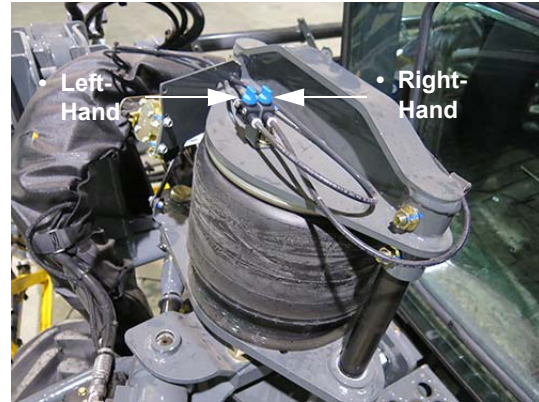

Air Suspension Valves
(Located on the left-hand front air bag)
-Typical View

6. Engage the parking brake.
7. **Turn the engine OFF before connecting any hoses or electrical lines!**
8. Connect all Solution, Foam Marker (if equipped), NORAC® (if equipped), Hydraulic, and Electrical Connections.

Solution Connection



Solution Connection
(Located on the front
right-hand side of machine)
-Typical View

Solution Connection (Dry Mate)

-If Equipped

- Install Solution Connections together.
- Push both Solution Connection Cam Lock Levers in the DOWN position.

- Rotate the bottom Solution Connection Valve in the fully COUNTER-CLOCKWISE (Open) position.
- Rotate the top Solution Connection Valve in the fully COUNTER-CLOCKWISE (Open) position.

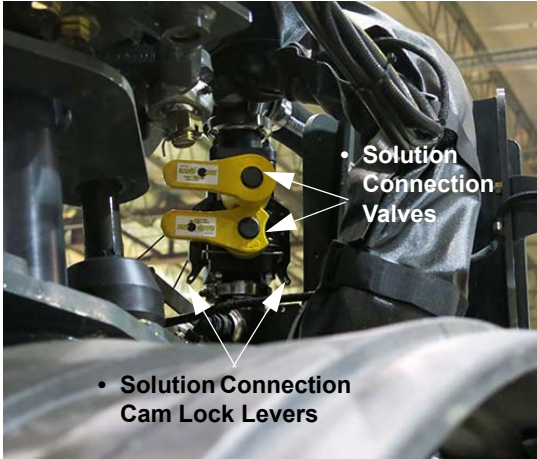

Solution Connection Valves and Cam Lock Levers
(Located on the front right-hand side of machine)
-Typical View

* View shown from behind front right-hand wheel

Foam Marker Connection

-If Equipped



Foam Marker Connection
(Located on the front right-hand side of machine)
-Typical View

NORAC Connection

-If Equipped



NORAC Connection - *if equipped*
(Located on the front right-hand side of machine)
-Typical View

Hydraulic and Electrical Connections

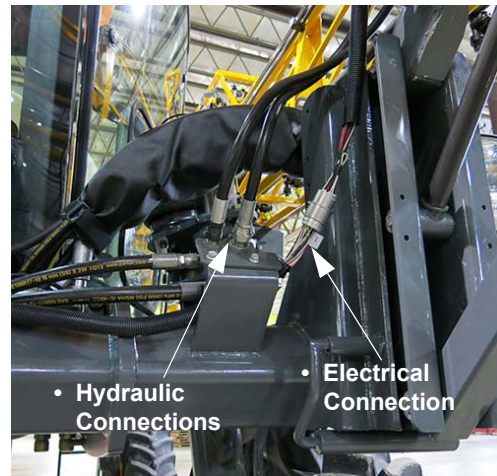

Hydraulic/Electrical Connections
"Standard"

(Located on the front left-hand side of machine)
-Typical View

- **Electrical** - Connect machine and boom electrical connectors together. Ensure snap ring is secured.
- **Hydraulic** - Remove caps from machine and boom hydraulic connections. Connect hydraulic hoses together and tighten.



Electrical Snap Ring
-Typical View

Quick Connect Multi-Coupler

-If Equipped

NOTE: If your machine is not equipped with the Quick Connect Multi-Coupler, proceed to the next numbered step.

- Install the Hydraulic/Electrical Connections (located on the left-hand side of attachment) into the Multi-Coupler Receptacle (located on front left-hand side of machine), ensuring full engagement.
- Push the Quick Connect Handle (located on the Hydraulic/Electric Multi-Coupler Assembly) UP to engage hydraulic/electrical connections.



Hydraulic/Electric Multi-Coupler Assembly
- If Equipped
(Located on the front
left-hand side of machine)

9. Rotate the NORAC Hand Valve - *if equipped* (located on the left and right-hand level cylinders) in the OPEN (counter-clockwise) position.



NORAC Hand Valve (2) - *if equipped*
(Located on the left and
right-hand level cylinders)
-Typical View

* Right-hand level cylinder shown

10. Start the engine.
11. If the air bags were previously deflated, raise the machine by rotating the corresponding Air Suspension Valves in the CLOCKWISE (Inflate) position.
12. Press and hold the Transom Switch (located on the Hydrostatic Drive Control Handle) in the UP position to raise the boom until the Attachment Hooks fully engage.

NOTE: Press and hold the Transom Switch only until the Attachment Hooks become fully engaged.



Transom Switch - UP
(Located on the Hydrostatic
Drive Control Handle)
-Typical View

NOTE: Raising the attachment will allow the weight of the boom to pull the Attachment Hooks over the Mounting Pins. You will notice a change of weight as the machine begins to support the attachment.

- Engage the Quick-Tach Lock Assemblies by pushing the Lock Pins IN, ensuring full engagement.

NOTE: If necessary, adjust the level cylinders to free the Lock Pins.

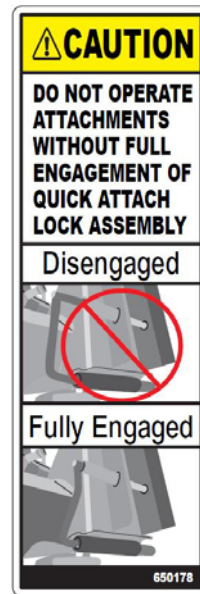

Lock Pin
-Typical View
*** Engaged position shown**

- Place boom stands in the TRAVEL position by removing the lock pin and mounting bolt and sliding the leg all the way UP (on each side).

NOTE: Reinstall the mounting bolts and lock pins to secure leg in the travel position (on each side).

See “Boom Stands” elsewhere in this section for further information.

NOTICE

Do not operate the boom while the boom stands are in the lowered position. Failure to comply may result in property damage.



Boom Stand in “Travel” Position
-Typical View

Disconnecting the Boom

Before disconnecting the boom, determine a proper storage location. When choosing a place to store the boom, there are three important things to keep in mind:

Is the ground level?

The ground must be level to help prevent the attachment from falling over. Level ground will also minimize stress on the frame of the attachment when in storage.

Is there enough space?

The attachment needs to be partially open for it to stand properly, but be aware of the room that is needed for the attachment and adequate space to travel around it safely.

Is it accessible?

The attachment needs to be positioned so you can connect easily. Ensure there is enough room and that the attachment is not blocked, or blocking other items.

If temporarily storing the attachment on a soft surface (such as grass), it is recommended to place blocks or wood beneath the stands’ feet to prevent the attachment from sinking into the ground.

NOTE: It is NOT recommended to store the attachment on a soft surface for an extended period of time, due to the risk of settling soil, even when blocks or wood are used.

Unfolding the Boom for Storage

The booms must be partially open for stability when unattached from the machine. Unfold the booms approximately 45-degrees while maintaining sufficient clearance for repositioning during reattachment. This position will allow the booms to sit level with the transom without causing excessive stress on either part. It will also keep the weight from shifting too much in either direction (rearward or forward), which could cause the boom to tip over and/or difficulty in connecting or disconnecting the attachment.

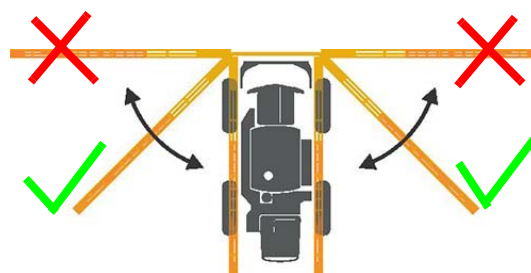

-Typical View

1. Press and hold the corresponding Left and Right Boom Switches (located on the Hydrostatic Drive Control Handle) in the UP position to remove boom wings from cradles.



Left and Right-Hand Boom Switches
(Located on the Hydrostatic Drive
Control Handle - Version 1)
-Typical View

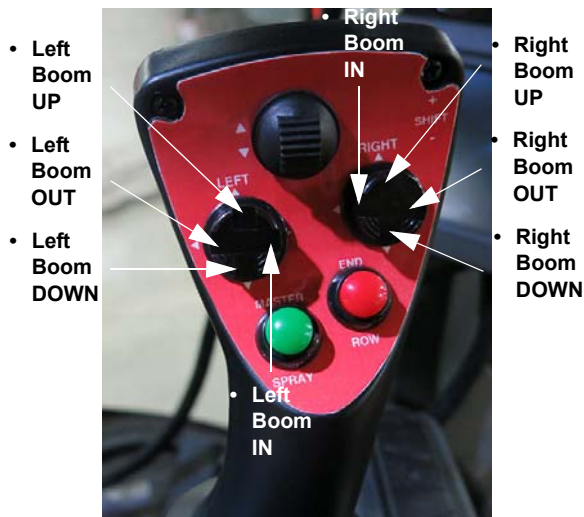

Left and Right-Hand Boom Switches
(Located on the Hydrostatic Drive
Control Handle - Version 2)
-Typical View

2. Press and hold the corresponding Left and Right Boom Switches in the OUT position to unfold the boom wings until **partially** open.

NOTE: Booms only need to be unfolded far enough to clear the boom cradles and lower (e.g. enough to clear the

front tires and allow room for steering to line up the boom). Do NOT fully extend.

3. Lower the boom and secure the boom stands (if equipped) in the DOWN position.
See “Boom Stands” elsewhere in this section for further information.

! WARNING

Lower boom to the ground before disengaging the Quick-Tach Lock Assemblies.

4. Press and hold the corresponding Left and Right Boom Switches in the DOWN position to point boom tips down (until tips touch the ground).
5. Disengage the Quick-Tach Lock Assemblies by pulling the Lock Pins (located on the front left and right-hand side of machine) OUT as far as it will go until it is in the “lock-out” position.

NOTE: “Lock-out” position prevents re-locking while attaching or detaching the attachment.

NOTE: If necessary, adjust the level cylinders to free the Lock Pins.

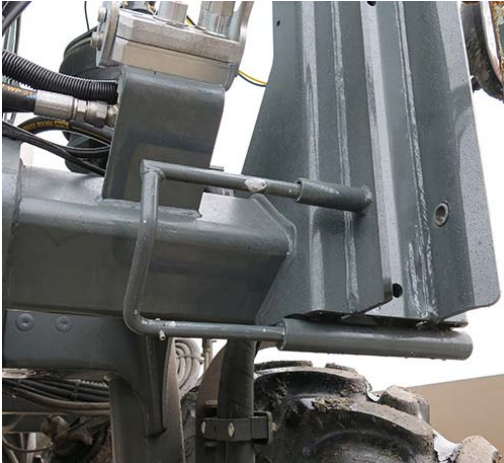

Lock Pin
(Located on the front left and
right-hand side of machine)
-Typical View

** Disengaged position shown*

6. If necessary, lower the machine by rotating the corresponding Air Suspension Valves (located on the left-hand front air bag) in the COUNTER-CLOCKWISE (Deflate) position.

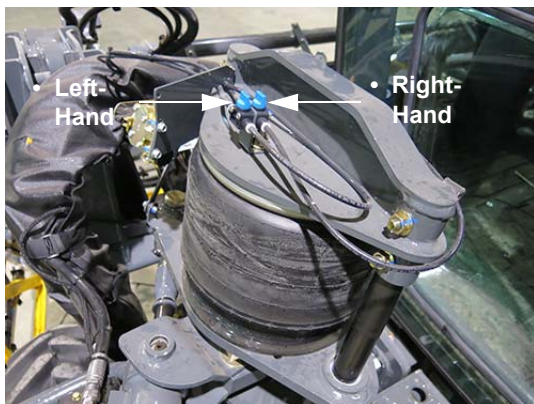

Air Suspension Valves
(Located on the left-hand front air bag)
-Typical View

7. Ensure the Boom Solution Valve Switches (located on the side console) are in the OFF position.



Boom Solution Valve Switches
(Located on the side console)
-Typical View

8. Disconnect the Solution, Foam Marker (if equipped), and NORAC (if equipped) Connections, ensuring not to leave the ends in an area where they may become damaged or contaminated.

Solution Connection



Solution Connection
(Located on the front
right-hand side of machine)
-Typical View

Solution Connection (Dry Mate)

-If Equipped

- Rotate the top Solution Connection Valve in the fully CLOCKWISE (Close) position.
- Rotate the bottom Solution Connection Valve in the fully CLOCKWISE (Close) position.

- Lift the Solution Connection Cam Lock Levers in the UP position to disengage the solution connections.
- Install provided dust caps on the solution connection openings.

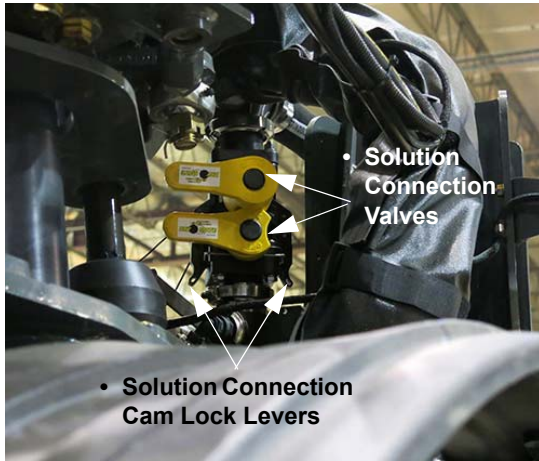

• Solution Connection Valves
• Solution Connection Cam Lock Levers

Solution Connection Valves and Cam Lock Levers
(Located on the front right-hand side of machine)
-Typical View

* View shown from behind front right-hand wheel

Foam Marker Connection

-If Equipped



Foam Marker Connection
(Located on the front right-hand side of machine)
-Typical View

NORAC Connection

-If Equipped



NORAC Connection - if equipped
(Located on the front right-hand side of machine)
-Typical View

9. Press and hold the Transom Switch (located on the Hydrostatic Drive Control Handle) in the DOWN position and slowly lower the boom/transom assembly until Attachment Hooks clear the Mounting Pins.



Transom Switch - DOWN
(Located on the Hydrostatic Drive Control Handle)
-Typical View

NOTE: If the air bags are inflated, a “bounce back” effect may be felt when the weight of the boom has been relieved from the machine. Once the air bags have cycled, the machine will adjust to the new weight.



Attachment Clearing Mounting Pin
-Typical View

10. Engage the parking brake.
- 11. Turn the engine OFF before disconnecting any hoses or electrical lines!**
12. Disconnect the Hydraulic/Electrical Connections (located on the front left-hand side of machine), ensuring not to leave the ends in an area where they may become damaged or contaminated.

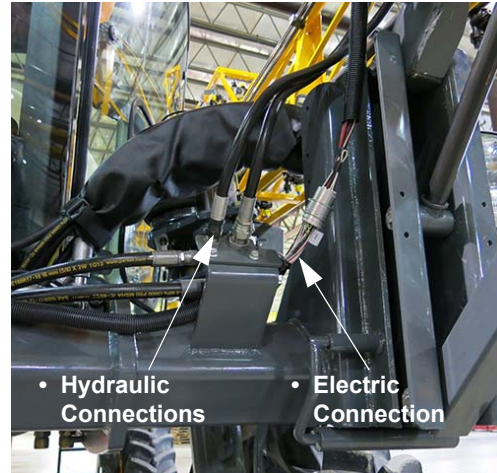

Hydraulic/Electrical Connections
“Standard”
(Located on the front
left-hand side of machine)
-Typical View

- **Electrical** - Loosen snap ring and disconnect electrical connectors.
- **Hydraulic** - Disconnect hydraulic hoses. Reinstall caps onto machine and boom hydraulic connections (if no other attachment will be installed).



Electrical Snap Ring
-Typical View

NOTE: Contact Hagie Customer Support for replacement caps.

CAUTION

Ensure caps are reinstalled onto hydraulic connections before starting the machine (if no other attachment will be installed). Failure to comply will result in hydraulic oil to eject from connection points and possible hydraulic system contamination.



NORAC Hand Valve (2) - *if equipped*
(Located on the left and right-hand level cylinders)
-Typical View
* Right-hand level cylinder shown

Quick Connect Multi-Coupler
-If Equipped

NOTE: If your machine is not equipped with the Quick Connect Multi-Coupler Assembly, proceed to the next numbered step.

- Pull the Quick Connect Handle (located on the Hydraulic/Electric Multi-Coupler Assembly) DOWN to disengage hydraulic/electrical connections.
- Remove Hydraulic/Electrical Connections from the Multi-Coupler Receptacle.



Hydraulic/Electric Multi-Coupler Assembly
- *If Equipped*
(Located on the front left-hand side of machine)

14. If no other attachment is going to be installed, re-lock the Quick-Tach Lock Assemblies by pushing the Lock Pins IN.
15. Start the machine.
16. Disengage the parking brake and slowly back away from the boom.
17. If the air bags were previously deflated, raise the machine by rotating the corresponding Air Suspension Valves in the CLOCKWISE (Inflate) position.

Boom Stands

90/100' Spray Booms
-If Equipped

If your boom is equipped with boom stands, there will be two (2) located on the transom and one (1) located on each of the inner boom sections.

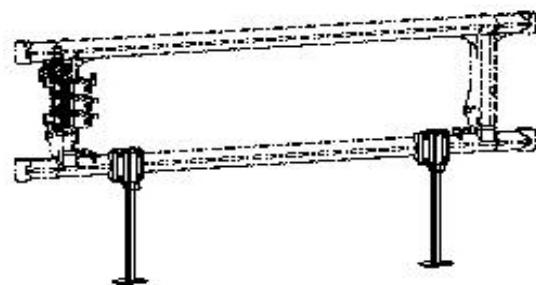

Booms Stands
(90' Boom)
-Typical View

13. Rotate the NORAC Hand Valve - *if equipped* (located on the left and right-hand level cylinders) in the CLOSED (clockwise) position.

Each boom stand has a leg with a “foot” on the bottom and a hex bolt in the top hole of the leg to secure it from sliding off, as well as a “snap” lock pin in the hole (located directly below the bracket) to maintain it’s position.

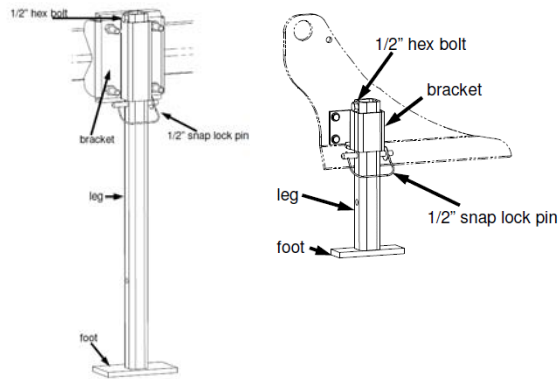

Boom Stand Assembly
-Typical View



Lock Pin
(Located on the outer
side of transom frame)
-Typical View

120/132' Spray Booms

Your boom is featured with two (2) boom stands (located on the transom).

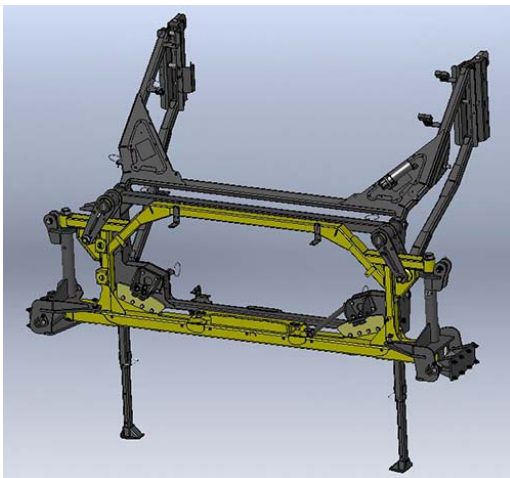

Booms Stands
(120/132' Boom)
-Typical View



Lock Pin Removed
-Typical View

2. While supporting the bottom “foot” end of boom stand, remove the Mounting Bolt (located on the outer side of transom frame) and slowly lower boom stand to desired position.

To Extend Booms Stands:

1. Remove Lock Pin (located on the outer side of transom frame) and set aside.



Mounting Bolt
(Located on the outer
side of transom frame)
-Typical View

3. With the boom stand at desired position, reinstall the Mounting Bolt, ensuring the holes of the boom stand and transom frame are properly aligned.



Boom Stand
(Extended position shown)
-Typical View

4. Reinstall Lock Pin (that was previously removed in Step 1).
5. Repeat Steps 1-4 on opposite side of boom.

NOTE: For additional adjustment, the “foot” end of the boom stand may also be adjusted to best suit your

situation (e.g. boom height, ground level, etc.) Adjust in the same manner as previously described.

6. Reverse steps to store booms stands in “travel” position.

QUICK-TACH SYSTEM - DETASSELER COMBO

WARNING

When connecting or disconnecting the attachment, observe the following safety precautions:

- Monitor both sides of the attachment during fold procedure.
- Select a safe area that is solid and level before unfolding/folding the attachment.
- Clear area of personnel.
- Check for overhead obstructions.
- Do not unfold or fold combo attachment near power lines. Contact with power lines can result in serious injury or death.

WARNING

Turn the engine OFF before connecting/disconnecting any hoses or electrical lines. Failure to comply may result in serious injury or death.

Connecting the Detasseler Combo Attachment

1. Square up to the combo attachment.
2. Lower the machine by rotating the corresponding Air Suspension Valves (located on the left-hand front air bag) in the COUNTER-CLOCKWISE (Deflate) position.

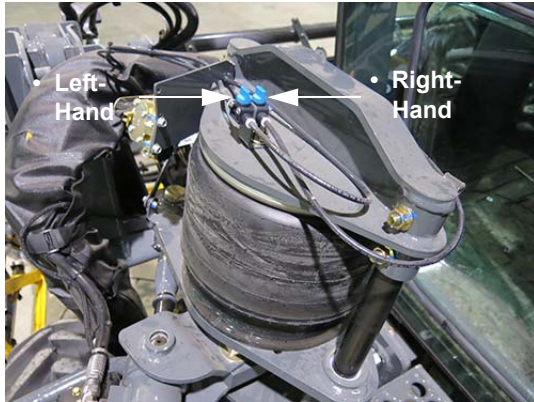

Air Suspension Valves
(Located on the left-hand front air bag)
-Typical View



Attachment Clearing Mounting Pin
-Typical View

- Disengage the Quick-Tach Lock Assemblies by pulling the Lock Pins (located on the front left and right-hand side of machine) OUT as far as it will go until it is in the “lock-out” position.

NOTE: “Lock-out” position prevents re-locking while attaching or detaching the attachment.



Lock Pin
(Located on the front left and
right-hand side of machine)
-Typical View

** Disengaged position shown*

- Raise the machine and engage Attachment Hooks by rotating the corresponding Air Suspension Valves in the CLOCKWISE (Inflate) position.

NOTE: Raising the machine will allow the weight of the attachment to pull the Attachment Hooks over the Mounting Pins. You will notice a change of weight as the machine begins to support the attachment.

- Engage the Quick-Tach Lock Assemblies by pushing the Lock Pins IN, ensuring full engagement.

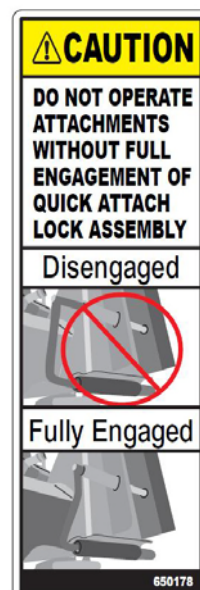

- Slowly pull into the combo attachment.
- Ensure the Attachment Hooks are high enough to clear the Mounting Pins.



Lock Pin
-Typical View

* Engaged position shown

8. Engage the parking brake.
9. **Turn the engine OFF before connecting any hoses or electrical lines!**
10. Install the Hydraulic/Electric Connection (located on the left-hand side of combo attachment) into the Multi-Coupler Receptacle (located on left-hand side of machine), ensuring full engagement.



Hydraulic/Electric Multi-Coupler Assembly
(Left-hand side of machine shown)
-Typical View

11. Push the Quick Connect Handle UP to engage left-hand hydraulic/electrical connections.
12. Press and hold the red Release Button (located on the right-hand quick connect

- handle) and lower handle into DOWN position.
13. Remove the Hydraulic Connection Cover (located on right-hand side of machine) and set aside.

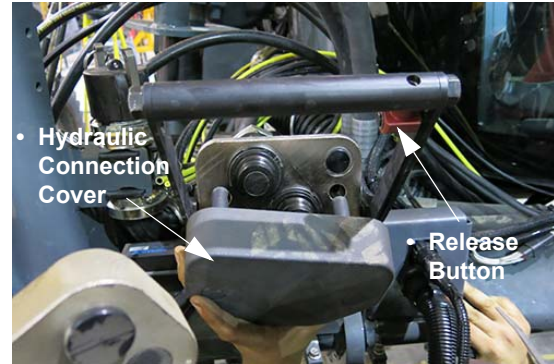

Hydraulic Connection Cover and Release Button
(Right-hand side of machine shown)
-Typical View

14. Install the Hydraulic Connection (located on the right-hand side of combo attachment) into the Multi-Coupler Receptacle (located on right-hand side of machine), ensuring full engagement.



Hydraulic Multi-Coupler Assembly
(Right-hand side of machine shown)
-Typical View

15. Press and hold the red Release Button and push Quick Connect Handle UP to engage right-hand hydraulic connections.
16. Install the Electrical Connections (located on the right-hand side of combo attachment) into the Electrical Ports

(located on the right-hand side of machine).

NOTE: Turn Electrical Connections “clockwise” to engage.



Electrical Connections
(Right-hand side of machine shown)
-Typical View

17. Remove the Securement Pins (located on the inward side of each combo attachment stand) and set aside.

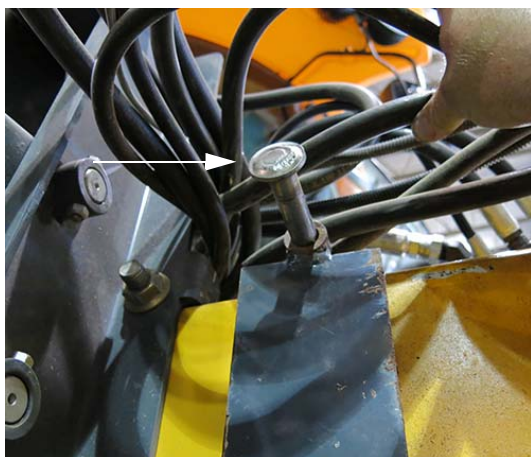

Securement Pin
(Located on the inward side of each combo attachment stand)
-Typical View

18. Remove the Stop Plate (located on the inward side of each combo attachment stand) and set aside.



Stop Plate
(Located on the inward side of each combo attachment stand)
-Typical View

19. Remove the combo attachment stands and set aside.

Disconnecting the Detasseler Combo Attachment

NOTICE

Stagger detasseling heads before folding the outriggers. Failure to comply will result in property damage.

⚠ WARNING

Ensure combo attachment is in the fully FOLDED position before detaching from machine. Failure to comply may result in serious injury or death and will result in property damage.

Before disconnecting the combo attachment, determine a proper storage location. When choosing a place to store the attachment, there are three important things to keep in mind:

Is the ground level?

The ground must be level to help prevent the attachment from falling over. Level ground will also minimize stress on the frame of the attachment when in storage.

Is there enough space?

Be aware of the room that is needed for the attachment and adequate space to travel around it safely.

Is it accessible?

The attachment needs to be positioned so you can connect easily. Ensure there is enough room and that the attachment is not blocked, or blocking other items.

If temporarily storing attachment on a soft surface (such as grass), it is recommended to place blocks or wood beneath each of the combo attachment stands to prevent the attachment from sinking into the ground.

NOTE: It is NOT recommended to store the attachment on a soft surface for an extended period of time, due to the risk of settling soil, even when blocks or wood are used.

1. Using the corresponding Lift Up/Down Switches (located on the Tasselrol® Control Panel), stagger the detasseling heads.
 - Lower the two center detasseling heads all the way DOWN.
 - Raise all the detasseling heads on one side to approximately half of the fully raised height.
 - Raise the detasseling heads on the opposite side to the fully raised height.



Lift Up/Down Switches
(Located on the Tasselrol Control Panel)
-Typical View



Staggered Detasseling Heads
-Typical View

NOTE: If your DTB is equipped with the 4-2 feature, refer to “4-2 Detasseler Combo Attachment - Adjustable” provided elsewhere in this manual for information on folding and sequence valve adjustments.

2. Slowly fold the outriggers in by pressing and holding the corresponding Left/Right Fold Switches (located on the Detasseling Control Panel) in the UP (Fold) position, making adjustments (as necessary) to the height of the detasseling heads.



Left/Right Fold Switches
(Located on the Detasseling Control Panel)
-Typical View

NOTICE

Do not attempt to make any adjustments to the detasseling heads after the outriggers are folded. Failure to comply may cause the stalk guides or depth command sensor bars to entangle, resulting in equipment damage.

3. Engage the parking brake.
4. **Turn the engine OFF before disconnecting any hoses or electrical lines!**
5. Install the combo attachment stands beneath attachment.
6. Install Stop Plate and Securement Pin on the inward side of each combo attachment stand.



Stop Plate/Securement Pin Assembly
-Typical View

7. Pull the Quick Connect Handle (located on the left-hand side of machine) DOWN to disengage hydraulic/electrical connections.
8. Remove Hydraulic/Electric Connection from the Multi-Coupler Receptacle.

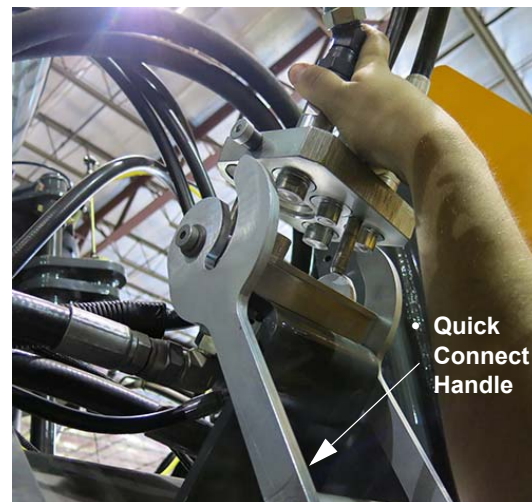

Hydraulic/Electric Multi-Coupler Assembly
(Left-hand side of machine shown)
-Typical View

9. Press and hold the red Release Button (located on the right-hand quick connect handle) and pull handle DOWN to disengage hydraulic connections.

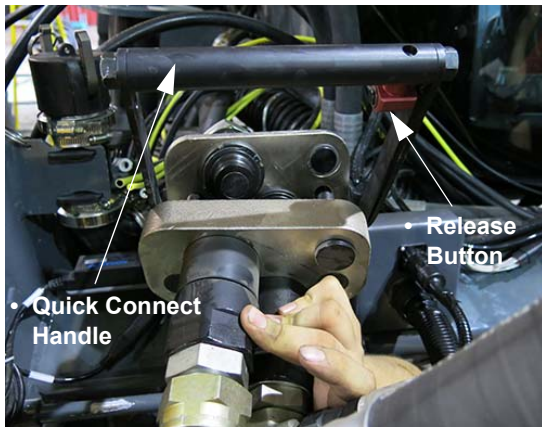

Hydraulic Multi-Coupler Assembly
(Right-hand side of machine shown)
-Typical View

10. Remove Hydraulic Connection from the Multi-Coupler Receptacle.
11. Reinstall Hydraulic Connection Cover (located on right-hand side of machine).



Hydraulic Connection Cover
(Right-hand side of machine shown)
-Typical View

12. Remove the Electrical Connections from the Electrical Ports (located on the right-hand side of machine).

NOTE: Turn Electrical Connections “counter-clockwise” to disengage.



Electrical Connections
(Right-hand side of machine shown)
-Typical View

13. Disengage the Quick-Tach Lock Assemblies by pulling the Lock Pin (located on the front left and right-hand side of machine) OUT as far as it will go until it is in the “lock-out” position.

NOTE: “Lock-out” position prevents re-locking while attaching or detaching the attachment.



Lock Pin
(Located on the front left and right-hand side of machine)
-Typical View
** Disengaged position shown*

14. Start the engine.
15. Lower the machine by rotating the corresponding Air Suspension Valves (located on the left-hand front air bag) in the

COUNTER-CLOCKWISE (Deflate)
position.

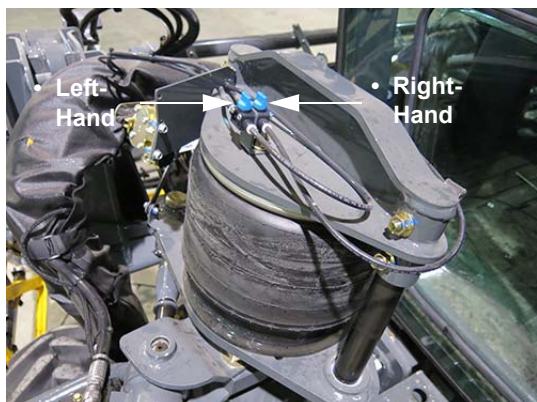

Air Suspension Valves
(Located on the left-hand front air bag)
-Typical View

16. Disengage the parking brake and slowly back away from the combo attachment.
17. If no other attachment is going to be installed, re-lock the Quick-Tach Lock Assemblies by pushing the Lock Pins IN.

NOTE: Install provided covers on disconnection points to avoid damage and contamination. Contact Hagie Customer Support for replacement covers.

18. Raise the machine by rotating the corresponding Air Suspension Valves in the CLOCKWISE (Inflate) position.

AIR SUSPENSION EXHAUST (Air Bags)

The Air Suspension Exhaust System is used to manually inflate/deflate the air bags on your machine, providing you with a smooth, consistent ride quality. It also provides ease when connecting and disconnecting attachments.

NOTE: Inspect air bags daily for leaks and/or cracking.

To Inflate/Deflate the Air Bags

- Rotate the corresponding Air Suspension Valves (located on the left-hand front and

rear air bags) in the COUNTER-CLOCKWISE position to deflate.

- Rotate the corresponding Air Suspension Valves in the CLOCKWISE position to inflate.

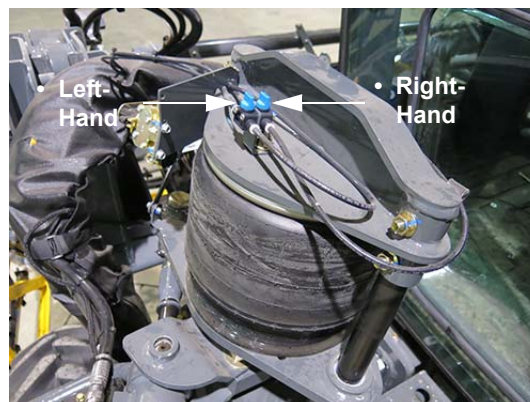

Air Suspension Valves
(Located on the left-hand front and rear air bags)
-Typical View

* Front left-hand air bag shown

HAND WASH SYSTEM

CAUTION

The Hand Wash System is not a substitute for Personal Protective Equipment (PPE). Always use the proper PPE (safety eye wear, face shields, protective clothing, etc.) when handling agricultural chemicals.

NOTICE

Keep hand wash tank full of fresh water at all times for immediate use should contact with hazardous chemicals occur.

NOTICE

Fill hand wash tank with fresh water only.

NOTICE

The Hand Wash System has been tested using RV-type antifreeze. Fill hand wash tank with fresh water and drain before initial use.

Your machine is equipped with a Hand Wash System, which is featured with two separate water outlets for your convenience.

Filling the Hand Wash Tank

NOTE: Hand Wash Tank capacity = 4 gallons (15 L)

- Remove Fill Cap (located on the side of Hand Wash Tank) and set aside.

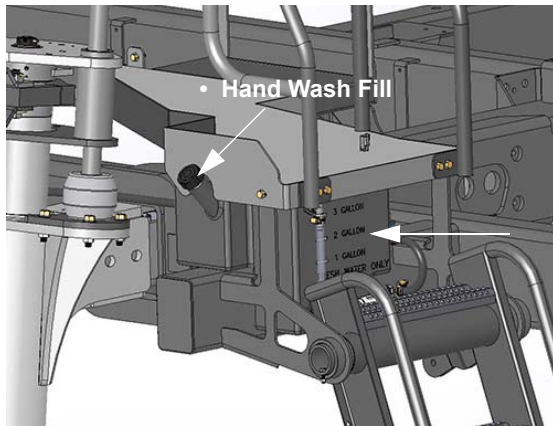

Hand Wash Tank
(Located beneath platform near ladder)
-Typical View

- Fill Hand Wash Tank with fresh water.
- Reinstall Fill Cap.

To Dispense Fresh Water From Upper Water Outlet

- Press and hold the Hand Wash Foot Pedal (located along lower handrail on left-hand side of machine).



Upper Water Outlet/Hand Wash Foot Pedal
(Located along lower handrail on left-hand side of machine)
-Typical View

- Release foot pedal when finished.

To Dispense Fresh Water From Lower Water Outlet

- Turn Hand Wash Valve (located near bottom of Hand Wash Tank) in the “clock-wise” (Open) position.

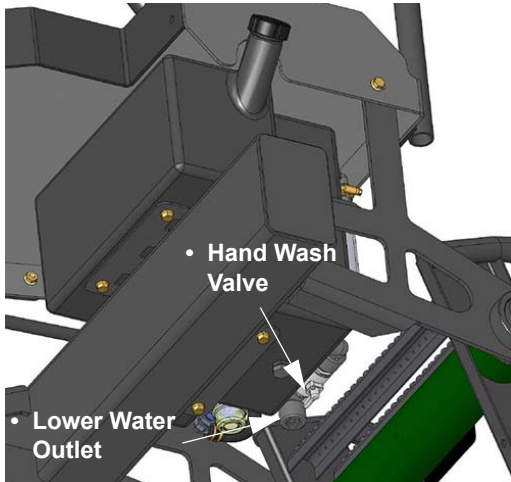

Lower Water Outlet/Hand Wash Valve
(Located near bottom of Hand Wash Tank)
-Typical View

- Close Hand Wash Valve when finished.

*NOTE: Remove Hand Wash Strainer
(located near bottom of Hand Wash
Tank) and clean strainer screen
periodically to avoid dirt and debris
from entering the system.*

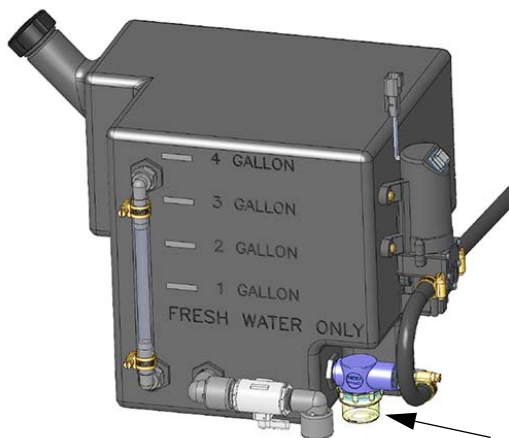

Hand Wash Strainer
(Located near bottom of Hand Wash Tank)
-Typical View

HOOD OPERATION

The rear hood may be opened to access many of the machine's service points (e.g. engine and hydraulic components).

To Open Hood

- Unlock the two Hood Latches (located on each side of top hood).



Hood Latch (2)
(Located on each side of top hood)
-Typical View

- Press and hold the Hood Switch (located ahead of rear hood above the radiator screen) in the LEFT position (when facing rear of machine).
- Release Hood Switch when hood has opened to desired position.

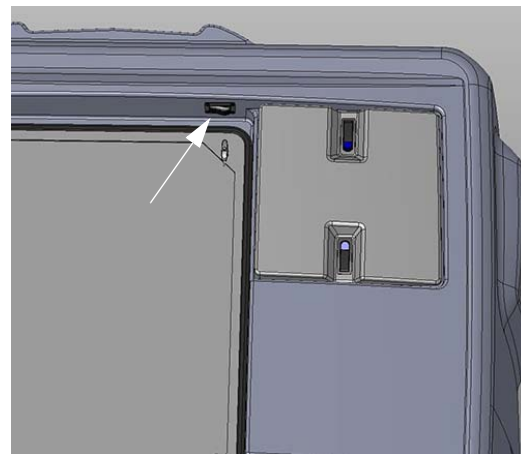

Hood Switch
(Located ahead of rear hood
above the radiator screen)
-Typical View

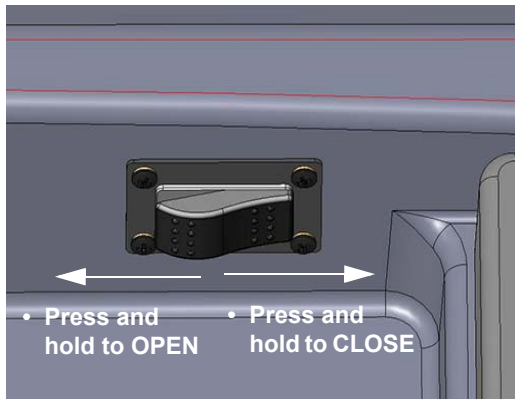

-Typical View



Rear Hood
(Closed position shown)
-Typical View



Rear Hood
(Open position shown)
-Typical View

- Lock the two Hood Latches.

Powering the Hood Actuator (when battery charge is depleted)

Refer to “Engine - Starting” provided in the *Engine and Drive Systems Section* elsewhere in this manual for information on jump starting the machine.

TALL CORN PACKAGE - INSTALLATION

- If Equipped

NOTE: Ensure correct Belly Shield configuration before installing.

To Close Hood

- Press and hold the Hood Switch in the RIGHT position (when facing rear of machine) until hood is fully retracted and comes to a complete stop.

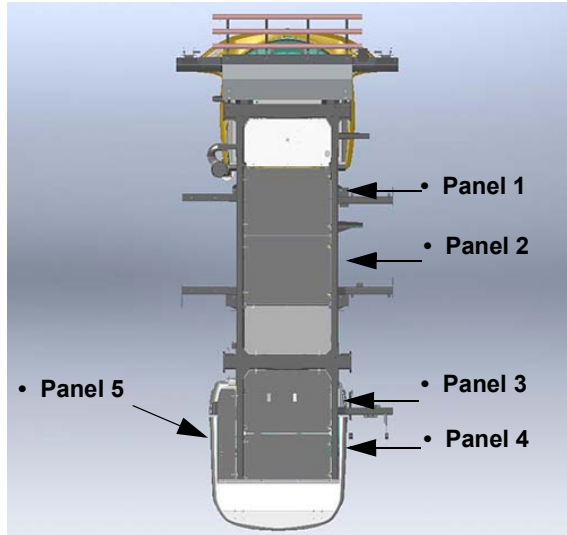

Belly Shield Installation
-Typical View

* View shown from bottom side of machine

NOTE: Two persons are required when installing the Tall Corn Package.

Installing Belly Shields (1-3)

1. Install Securement Pin Assembly (Hanger Pin and Securement Pin) onto each Retaining Bracket (located along frame).

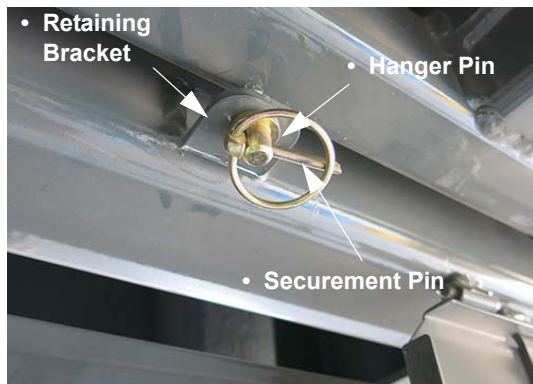

Retaining Bracket/
Securement Pin Assembly
-Typical View

2. Starting with Panel 1, install Support Hook Assemblies into the corresponding Hinge Bushings (located along frame).
3. Install Cotter Pin onto the end of each support hook.

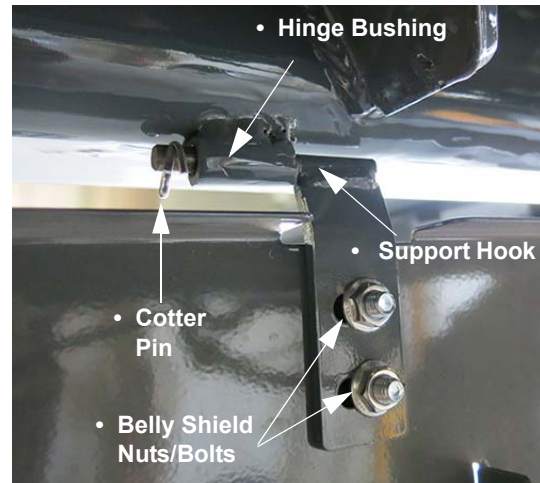

-Typical View

NOTE: Ensure belly shield nuts and bolts are loose.

4. On opposite side of machine, remove previously installed Securement Pins (from Hanger Pins).
5. Lift panel and align hole openings with Hanger Pins. Attach by reinserting the Securement Pins.

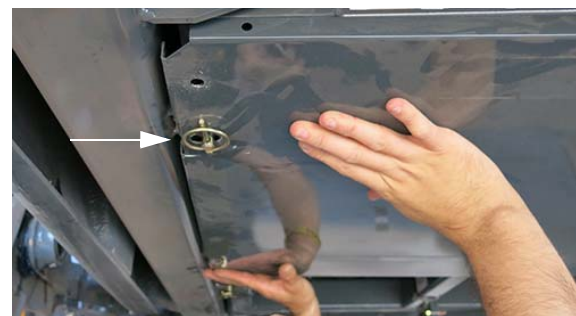

Securement Pin
(Installed into Hanger Pin)
-Typical View

6. Using a 1/2" wrench or socket, tighten the belly shield nuts and bolts, as shown.



-Typical View

7. Repeat previous steps to install Panels 2 and 3.

Installing Belly Shields (4-5) and Brush Curtain

1. Install Securement Pin Assembly (Hanger Pin and Securement Pin) onto each Retaining Bracket (located along frame).

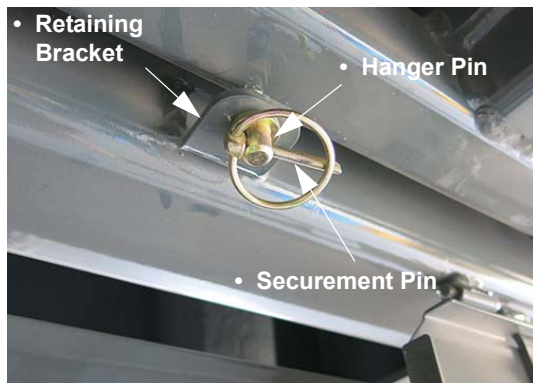

Retaining Bracket/
Securement Pin Assembly
-Typical View

2. Starting with Panel 4, install Support Hook Assemblies into the corresponding Hinge Bushings (located along frame).
3. Install Cotter Pin onto the end of each support hook.

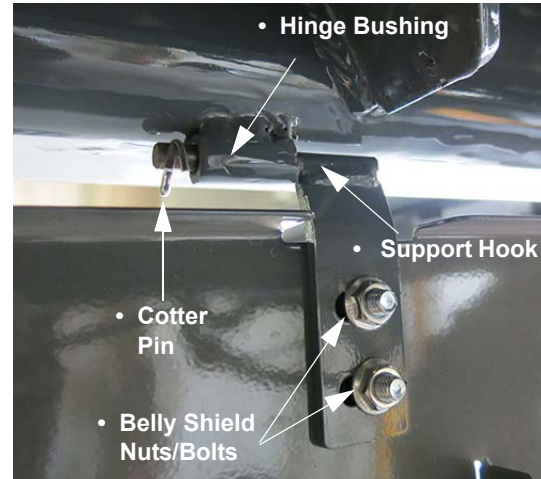

-Typical View

NOTE: Ensure belly shield nuts and bolts are loose.

4. Repeat Steps 2-3 to install Panel 5, ensuring belly shield nuts and bolts are loose.
5. Install Hanger Pins along side of Panels 4 and 5, as shown.



Hanger Pins
(Install three pins onto Panel 4 and one pin onto Panel 5, as shown)
-Typical View

NOTE: Ensure each Hanger Pin opening is facing UP (toward length of panel), as shown in the following photo.



Hanger Pin Installation
-Typical View

6. On opposite side of machine, remove previously installed Securement Pins (from Hanger Pins).
7. Lift panel and align hole openings with Hanger Pins. Attach by reinserting the Securement Pins.

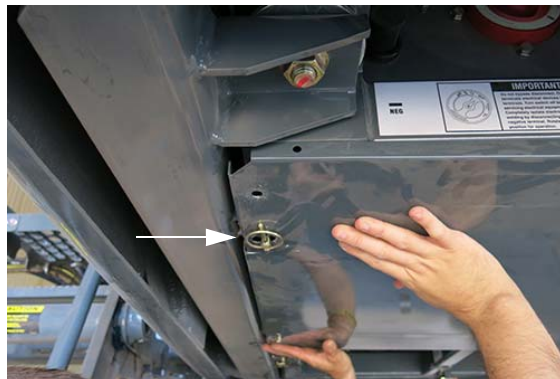

Securement Pin
(Installed into Hanger Pin)
-Typical View

8. Using a 1/2” wrench or socket, tighten the belly shield nuts and bolts, as shown.



-Typical View

9. Lift and secure Panel 5, tightening belly shield nuts and bolts in the same manner.

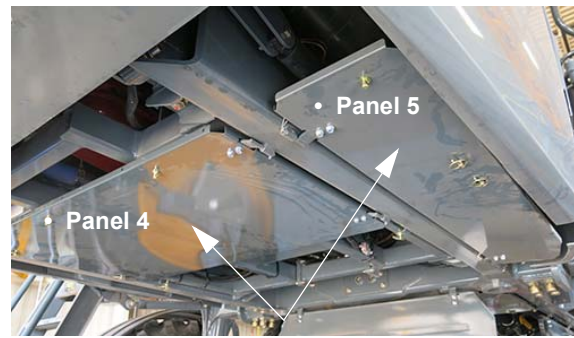

Rear Belly Shield Installation
-Typical View

To Assemble/Install Brush Curtain:

10. Place Curtain Mounting Bracket (bend side up) beneath edge of Brush Curtain, aligning the pre-drilled holes on each.
11. Arrange Curtain Support Strips along the edge of Brush Curtain, aligning the pre-drilled holes.

NOTE: Ensure the notches of each Curtain Support Strip are facing inward (where they will later be adjoined together).

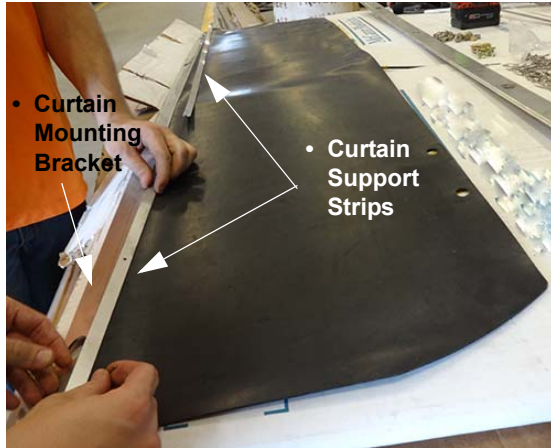

-Typical View

12. Starting at the end of the assembly, insert a 1/8" stainless steel rivet through the top of Curtain Support Strip, Brush Curtain, and Curtain Mounting Bracket.

NOTE: Ensure Curtain Mounting Bracket bend is facing UP, as shown in the following photo.



Brush Curtain Assembly
-Typical View

13. Use a rivet gun to secure.



-Typical View

14. Repeat process to secure the remainder of the assembly, ensuring that the notches of Curtain Support Strips adjoin together.

15. Install the assembled Brush Curtain onto the previously installed Hanger Pins (located on Panels 4 and 5).



Brush Curtain Installation
-Typical View

16. Install Securement Pins into each of the Hanger Pins.

NOTE: Install the two center pins first, followed by the two outer pins.



Securement Pin
(Installed into Hanger Pin)
-Typical View

17. Remove the four (4) mounting bolts (two located on each side of hood bracket).



Mounting Bolts
(Two located on each side of hood bracket)
-Typical View

** Your machine may vary in appearance,
depending on available equipment.*

18. Insert bolts (that were just removed) through the corresponding Brush Curtain holes (located at bottom of curtain) and reinstall bolts to hood bracket, as shown in the following photo.



Brush Curtain Attached to Hood
-Typical View

19. Belly Shield and Brush Curtain installation complete.



Belly Shield/Brush Curtain Installation
-Typical View

Installing Front Brush Guard

1. Remove the two (2) Mounting Bolts - front and rear (located on the right-hand cross member hose assembly mounting bracket).

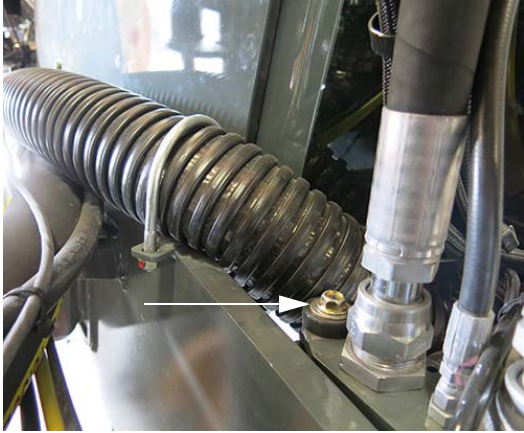

Mounting Bolts (2) - Front/Rear
(Located on the right-hand cross member
hose assembly mounting bracket)
-Typical View
**Rear bolt shown*

2. Insert two (2) Mounting Bracket Spacers to the bottom of the front and rear bracket assembly, as shown in the following photo.
3. Install two (2) new Mounting Bolts and Washers through the top of the front and rear of bracket assembly, as shown in the following photo.

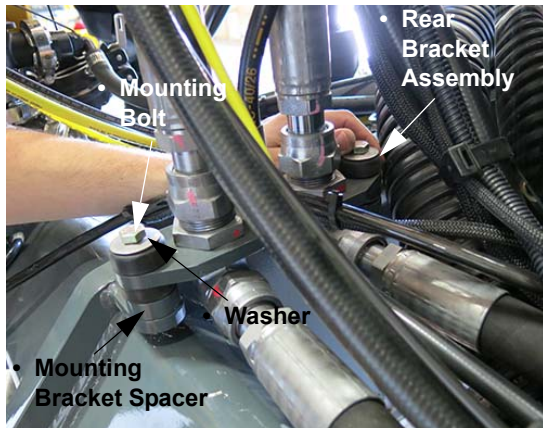

-Typical View

4. Install Brush Guard Mounting Bracket between right-hand cross member and hose assembly, as shown.



Brush Guard Mounting Bracket
(Right-hand side of machine shown)
-Typical View

5. Install nut to the bottom of each Mounting Bracket and tighten using a 9/16" wrench.

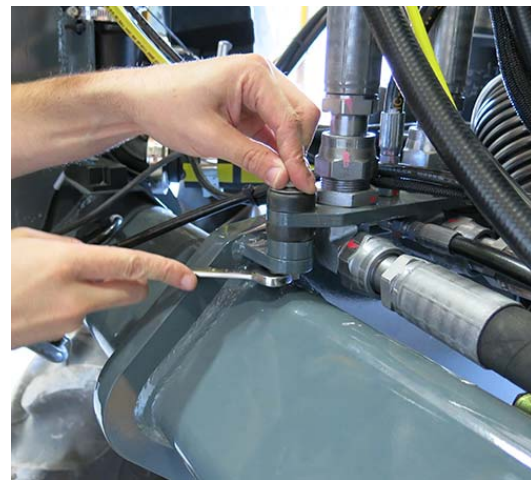

-Typical View

6. Install additional Brush Guard Mounting Bracket on left-hand cross member, as shown.



Brush Guard Mounting Bracket
(Left-hand side of machine shown)
-Typical View

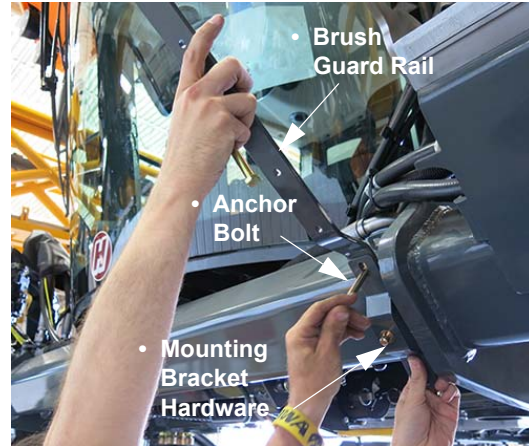

Brush Guard Rail Assembly
-Typical View

7. Assemble Mounting Bracket Hardware (bracket, hanger pin, and bolt) together.

NOTE: Ensure the hanger pin hole opening is facing toward the length of the bracket.

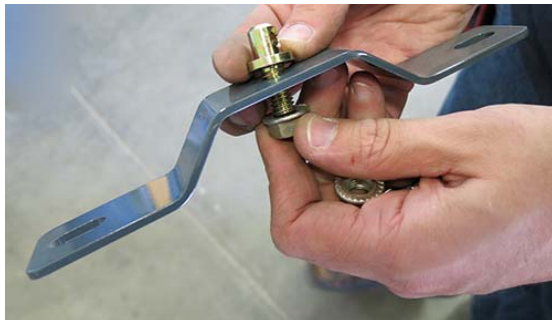

Mounting Bracket Hardware
-Typical View



Anchor Bolt Assembly
-Typical View

8. Attach Brush Guard Rail to left-hand cross member by installing 4” Anchor Bolts through the top and bottom of the Mounting Bracket Hardware, and securing to the previously installed Brush Guard Mounting Bracket.

9. Repeat Step 8 to install Brush Guard Rail to right-hand cross member.

NOTE: The outer left and right-hand Brush Guard Rails must be installed prior to the center rails.

10. Install each center Brush Guard Rail by attaching with Rail Support and two (2) 7 1/2” Anchor Bolts, as shown.

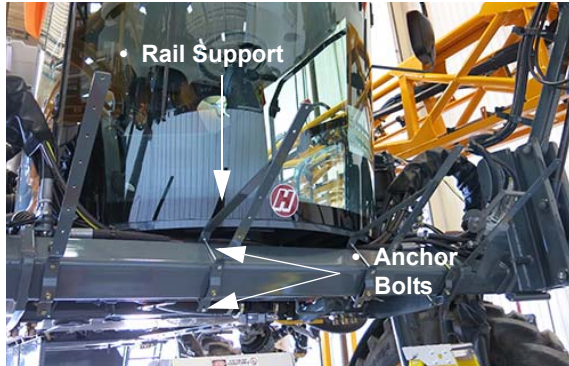

Center Brush Guard Rail Assembly
-Typical View



-Typical View

11. Fasten each center Brush Guard Rail and Rail Support together using a 5/16" x 1" bolt, as shown in the following photo. Tighten bolt with a 9/16" wrench.

13. Once proper distance is achieved, hand-tighten top and bottom Anchor Bolts on each side.

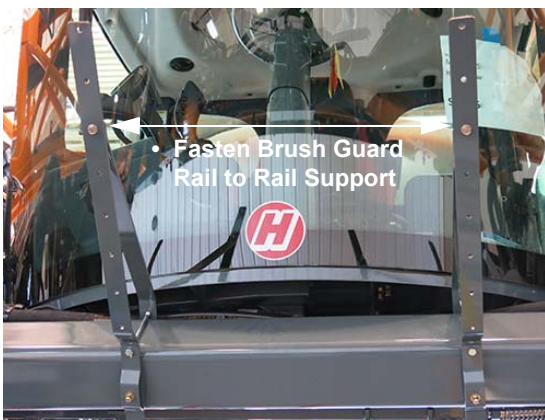

-Typical View



-Typical View

12. Using a tape measure, ensure the distance from the outer edge of the right and left-hand cross member support tube to the inner edge of the hanger pin (of the outer Brush Guard Rail) is 2 1/2" (6.4 cm), as shown in the following photo.

14. Using a tape measure, ensure the distance from the outer edge of the right and left-hand cross member support tube to the inner edge of the hanger pin (of the center Brush Guard Rail) is 24" (61 cm), as shown in the following photo.

NOTE: If needed, use a rubber mallet to obtain proper distance.

NOTE: If needed, use a rubber mallet to obtain proper distance.



-Typical View

15. Repeat Step 15 on opposite side, ensuring 24” (61 cm) distance.
16. Once proper distance is achieved, hand-tighten top and bottom Anchor Bolts of each center Brush Guard Rail.



-Typical View

17. If necessary, remove the Front Fill Valve Bolt (using a 1/2” wrench) and set aside.

NOTE: If Front Fill Valve is already oriented correctly, proceed to Step 23.



Front Fill Valve Bolt
-Typical View

18. Rotate the Front Fill Valve 180° (valve handle facing toward front of machine) and reinstall bolt.



-Typical View

19. Lower Front Fill Assembly.
20. Starting at the bottom, install Brush Guard Tubes to Brush Guard Rails, securing with U-Bolts and tightening with a 1/2” wrench.

NOTE: Ensure U-Bolts are not over-tightened. If the bolts are snugged too tight, the brush guard extensions will not extend properly.

NOTE: Ensure the Brush Guard Adjustment Clips located on each end of tube are facing upward when installing.

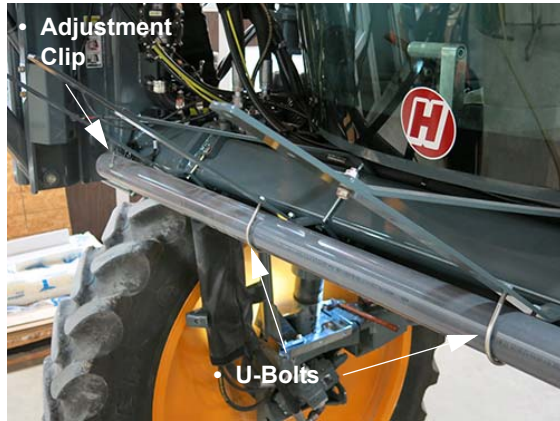

Brush Guard Tube
-Typical View



Brush Guard Adjustment Clip
(Located on the end of each tube)
-Typical View

21. Repeat process for remaining brush guards.



Brush Guard Installation
-Typical View

Brush Guard Extension

- Remove adjustment clip from pin (located on the end of each brush guard tube).
- Extend tube to desired position, ensuring hole openings align.
- Reinstall adjustment clip to pin.

Installing Front Shield

1. Pre-assemble support hook and bolts to the Front Shield (one side only) and hand-tighten with a 1/2" wrench, as shown in the following photo.
2. Install support hook into the corresponding hinge bushing (located beneath the front end of machine near tread adjust bolts).

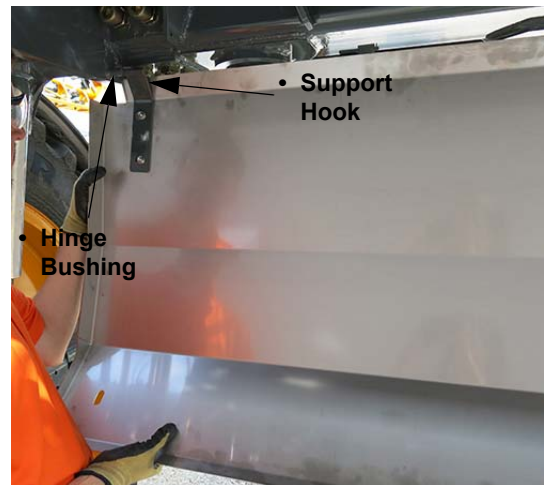

-Typical View

3. Install support hook into hinge bushing on opposite side of machine (without bolts and nuts).
4. Lift Front Shield and install bolts through back side of panel and support hook. Hand-tighten with a 1/2" wrench.



-Typical View

5. Lift Front Shield and install the four (4) Securement Pins into the previously installed hanger pins (located on front of machine).

NOTE: Brush Guard Rails may require adjustment to ensure proper alignment of the Front Shield.



Front Shield Installation
-Typical View

Installing Crop Dividers

1. Install two (2) black caps (located on each end of the four Crop Dividers).
2. Remove the three (3) Leg Mounting Bolts and set aside.
3. Slide Crop Divider Mounting Plate beneath leg plate, as shown in the following photo.

NOTE: If your machine is equipped with Severe Duty Legs, refer to the following “Mounting Plate/Bolt Installation - Severe Duty Legs” illustration for correct orientation of the Crop Divider Mounting Plate and bolts.

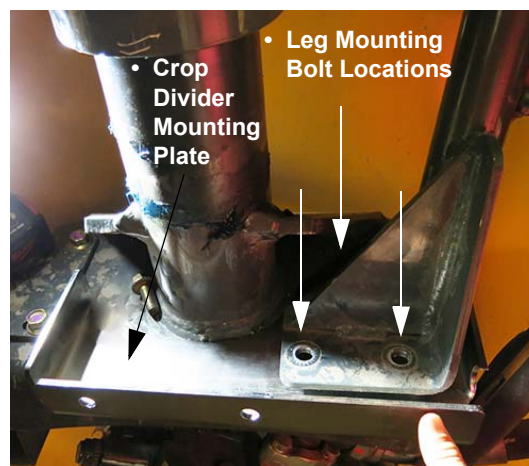

-Typical View

4. Align Leg Mounting Bolt and Crop Divider Mounting Plate holes and reinstall previously removed bolts, tightening with a 3/4” wrench or socket.
5. Install additional Mounting Plate Bolt, as shown in the following photo. Tighten with a 3/4” wrench or socket.



Mounting Plate Bolt
-Typical View

Mounting Plate/Bolt Installation (Severe Duty Legs)

-If Equipped

NOTE: If your machine is not equipped with Severe Duty Legs, proceed to the next numbered step.

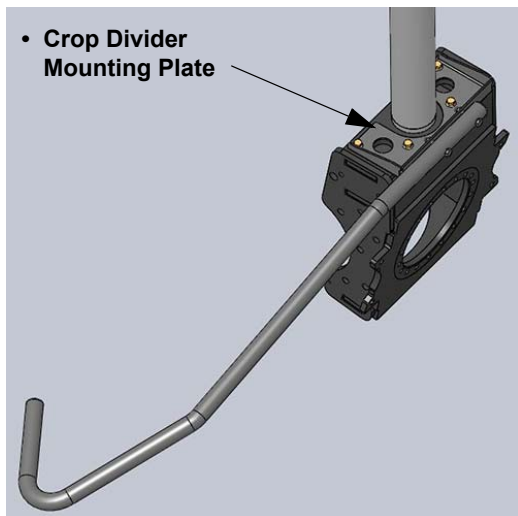

Mounting Plate/Bolt Installation
(Severe Duty Leg Option)
-Typical View

- Slide Crop Divider into mounting plate, as shown.

NOTE: Ensure the hook end of the Crop Divider is facing outward.



Installed Crop Divider
-Typical View

- Install two (2) Crop Divider Mounting Bolts through Crop Divider mounting

plate and tube. Install two (2) nuts and tighten with a 3/4" wrench or socket.



Crop Divider Mounting Bolt
-Typical View

- Repeat steps to install remaining Crop Dividers.

Installing Wheel Covers

NOTICE

Remove two (2) lug nuts at a time from the wheel bolts when installing the hub cap adapter plates.

- Remove two (2) lug nuts from two (2) of the wheel bolts and set aside.
- Install Hub Cap Adapter Plate onto the two bolts, as shown in the following photo.
- Reinstall the two lug nuts onto bolts and tighten to with a 30 mm air wrench. Refer to "Service - Bolt Torque" provided in the *Maintenance and Storage Section* elsewhere in this manual for further information.



Hub Cap Adapter Plate
-Typical View

4. Perform Steps 1-3 to install remaining adapter plates, ensuring only two (2) lug nuts are removed from the wheel bolts at one time.



-Typical View

5. Install the Hub Cap Adapter Weldment onto the outside of the previously installed Hub Cap Adapter Plates.

NOTE: Ensure the Hub Cap Adapter Weldment is flush with the face of the wheel hub.



Hub Cap Adapter Weldment
-Typical View

6. Install 1/2" bolt through the hub cap adapter assembly. Install nut to bolt and tighten with a 3/4" wrench.

NOTE: Repeat for each adapter assembly location around the wheel hub.



Hub Cap Adapter Bolt Installation
-Typical View

7. Install Wheel Cover onto the hub cap adapter assembly.

NOTE: Ensure the rectangular cut-out on the wheel cover is aligned with the tire valve stem, as shown.



-Typical View



-Typical View

8. Install 1/2" mounting bolt through the front of wheel cover and Hub Cap Adapter Weldment mounting holes.



Wheel Cover Mounting Bolt Installation
-Typical View

9. Install nut to mounting bolt and tighten with a 5/16" hex wrench.

NOTE: Repeat for each adapter assembly location around the wheel hub.

10. Install Valve Stem Access Panel to the Wheel Cover.
11. Install a 1/4" bolt through the access panel and wheel cover. Install nut to bolt and tighten with a 3/8" wrench.

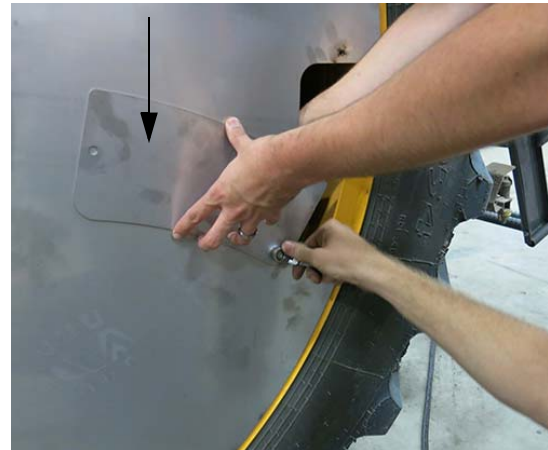

Valve Stem Access Panel
-Typical View

12. With hole openings aligned, install remaining 1/4" bolt (tighten with 3/8" wrench) and nut (tighten with 7/16" wrench).
13. Install Hub Cap Access Panel to center of wheel cover, ensuring the hole openings of each are properly aligned.



Hub Cap Access Panel
-Typical View

14. Install 1/4" bolt through access panel and wheel cover, tightening with a 3/8" wrench.
15. Wheel cover installation complete.



Wheel Cover Installation
-Typical View

TROUBLESHOOTING

Problem	Possible Cause	Suggested Remedy
Engine will not crank	<ul style="list-style-type: none"> • Dead battery • Poor battery connections • Starter or starter relay • Blown fuse in engine electric box • Battery Disconnect Switch in the OFF position • Parking Brake not engaged 	<ul style="list-style-type: none"> • Recharge or replace battery • Clean and tighten • Test (rebuild or replace) • Check fuse • Turn Battery Disconnect Switch to ON position • Engage Parking Brake
Engine will not start	<ul style="list-style-type: none"> • Fuel tank empty • Clogged fuel filter • Cold weather • Low starter speed • Blown fuse in engine electric box 	<ul style="list-style-type: none"> • Fill fuel tank • Replace fuel filters • Refer to the engine manufacturer's operation manual for cold weather starting • Check starter and battery • Check fuse
Engine overheats	<ul style="list-style-type: none"> • Engine overload • Dirty radiator core/fins/grille screen • Faulty radiator cap • Fan malfunction • Faulty thermostat • Low coolant level 	<ul style="list-style-type: none"> • Reduce load • Remove all foreign material and clean all items • Replace cap • Check fan speed • Replace thermostat • Refill to proper level with recommended coolant
Engine misfires: runs uneven/low power	<ul style="list-style-type: none"> • Water in fuel • Dirty air cleaner element • Poor grade of fuel • Fuel tank vent clogged • Clogged fuel filter 	<ul style="list-style-type: none"> • Drain, flush, replace filter, fill system • Replace element • Drain system, change to a higher fuel grade • Open fuel tank vent (in cap) • Replace fuel filter
Engine knocks	<ul style="list-style-type: none"> • Low oil level in crankcase • Cold engine 	<ul style="list-style-type: none"> • Add oil to full mark • Allow proper warm-up period, refer to engine manufacturer's operation manual
Solution Pump will not prime	<ul style="list-style-type: none"> • Low water level in pump • Air leak in suction line • Solution tank valve closed • Clogged or kinked vent line 	<ul style="list-style-type: none"> • Ensure solution tank is not empty (solution pump is self-priming) • Inspect and tighten all fittings in suction line • Open solution tank valve, allow air to leave the system • Inspect vent line for blockage or kinking

SECTION 10 –
MISCELLANEOUS



<p>Erratic reading on pressure gauge</p>	<ul style="list-style-type: none"> • Orifice in back of gauge clogged • Faulty gauge • Air leak in suction line • Solution strainers plugged • Glycerin leaking from gauge 	<ul style="list-style-type: none"> • Remove gauge, clean orifice, reinstall • Replace gauge • Inspect and tighten all fittings in suction line • Check solution strainers • Replace gauge
<p>Malfunction of electric solution valve</p>	<ul style="list-style-type: none"> • Faulty ground • Dirty contact terminals • Separation in wire • Faulty switch • Bad valve • Short in solenoid coil 	<ul style="list-style-type: none"> • Clean and tighten ground • Clean contact terminals • Check continuity and replace wire • Replace switch • Replace valve
<p>Solution pump not producing normal pressure</p>	<ul style="list-style-type: none"> • Clogged line strainer screen • Air leak in suction flow to pump • Restricted solution flow to pump • Suction hose collapsed • Hydraulic failure 	<ul style="list-style-type: none"> • Remove screen, clean thoroughly, tighten strainer cap to avoid air leak • Inspect and tighten all fittings on suction line • Ensure Main Tank Valve is completely open • Obstruction at inlet end of hose, causing high vacuum on hose • Contact Hagie Customer Support for assistance
<p>Machine will not move in either direction</p>	<ul style="list-style-type: none"> • Engine speed too low • Oil level in reservoir too low • Clogged filter • Hydrostatic System failure 	<ul style="list-style-type: none"> • Set engine at operating RPM before trying to move machine • Fill reservoir to proper level with approved oil (see Service: Fluids elsewhere in this section) • Replace charge filter • Contact Hagie Customer Support for assistance
<p>Machine will move in only one direction</p>	<ul style="list-style-type: none"> • Hydrostatic System failure 	<ul style="list-style-type: none"> • Contact Hagie Customer Support for assistance

Hydrostatic System responding slowly	<ul style="list-style-type: none"> • Engine speed too low • Oil in reservoir low • Cold oil • Plugged filter • Partially restricted suction line • Hydrostatic System failure 	<ul style="list-style-type: none"> • Set engine at operating RPM before trying to move the machine • Fill reservoir to proper level with approved oil (see Service: Fluids elsewhere in this section) • Allow adequate warm-up period • Check and replace filter • Inspect for collapsed suction hose • Contact Hagie Customer Support for assistance
Noisy Hydrostatic System	<ul style="list-style-type: none"> • Cold oil • Low engine speed • Oil level in reservoir low • Hydrostatic System failure 	<ul style="list-style-type: none"> • Allow adequate warm-up period • Increase engine speed • Fill reservoir to proper level with approved oil (see Service: Fluids elsewhere in this section) • Contact Hagie Customer Support for assistance
Entire hydraulic system fails to function	<ul style="list-style-type: none"> • Oil level in reservoir too low • Auxiliary hydraulic system failure 	<ul style="list-style-type: none"> • Fill reservoir to proper level with approved oil (see Service: Fluids elsewhere in this section) • Contact Hagie Customer Support for assistance
Noisy hydraulic pump	<ul style="list-style-type: none"> • Oil level in reservoir too low • Auxiliary hydraulic system failure 	<ul style="list-style-type: none"> • Fill reservoir to proper level with approved oil (see Service: Fluids elsewhere in this section) • Contact Hagie Customer Support for assistance
AWS System will not turn on	<ul style="list-style-type: none"> • AWS Button (located on the Machine Display) is OFF • Machine not in Field Mode • Sensor or valve malfunction 	<ul style="list-style-type: none"> • Turn AWS Button ON • Change machine's drive state to Field Mode • Contact Hagie Customer Support for assistance
AWS System is ON, but rear tires do not follow behind the front tires	<ul style="list-style-type: none"> • Machine speed is greater than AWS Shutoff Speed • Sensor or valve malfunction 	<ul style="list-style-type: none"> • This is left up to the operator's discretion • Contact Hagie Customer Support for assistance

SECTION 10 –
MISCELLANEOUS



<p>AWS System does not work, machine will only move at slow speed</p>	<ul style="list-style-type: none"> • Sensor malfunction 	<ul style="list-style-type: none"> • Move the Hydrostatic Drive Control Handle to NEUTRAL, wait for the “FAULT” drive state to disappear on the Machine Display, and restart machine <p><i>NOTE: In Road mode, the rear tires are locked until the machine is put into Field mode.</i></p> <ul style="list-style-type: none"> • Contact Hagie Customer Support for assistance
<p>Lifting mechanism will not lift</p>	<ul style="list-style-type: none"> • Bad cylinder • Blown relief valve • Relief valve set too low • Lift arms seized • Faulty electro-hydraulic valve 	<ul style="list-style-type: none"> • Check cylinder - remove, rebuild, or replace • Remove, inspect, replace with new • Contact Hagie Customer Support for assistance • Loosen mounting bolts, lubricate grease fittings (if equipped) • Refer to the Tasselrol user guide
<p>Cutter head blades, quad pullers, rollers, or ties will not turn</p>	<ul style="list-style-type: none"> • Oil level in reservoir too low • Oil not reaching pump • Faulty hydraulic pump • Faulty hydraulic motor(s) 	<ul style="list-style-type: none"> • Fill reservoir to proper level with approved oil • Remove suction hose from pump and check for proper flow, reinstall hose and all suction fittings • Replace hydraulic pump • Replace motor(s)
<p>Hydraulic motor leaking</p>	<ul style="list-style-type: none"> • Seal failure • Restricted case drain hose 	<ul style="list-style-type: none"> • Replace seal, turn heads on with low engine RPM • Inspect or replace hose
<p>No units will lift</p>	<ul style="list-style-type: none"> • Oil in reservoir low • Faulty valve • Relief valve in electro-hydraulic valve set too low 	<ul style="list-style-type: none"> • Fill tank to proper level • Repair or replace valve • Contact Hagie Customer Support for assistance
<p>No units will lower</p>	<ul style="list-style-type: none"> • All lift arm pivots too tight 	<ul style="list-style-type: none"> • Lubricate and loosen pivot points
<p>Only one unit will not lower</p>	<ul style="list-style-type: none"> • Faulty valve • Lift arm pivot too tight 	<ul style="list-style-type: none"> • Replace valve • Lubricate and loosen pivot point
<p>All units lift slowly</p>	<ul style="list-style-type: none"> • Hydraulic oil not at operating temperature • Faulty valve • Lift arm pivots too tight • Relief valve in electro-hydraulic valve system set too low 	<ul style="list-style-type: none"> • Allow time for oil to warm up • Replace valve • Lubricate and loosen pivot points • Contact Hagie Customer Support for assistance

Only one unit lifts slowly	<ul style="list-style-type: none"> • Faulty valve • Lift arm pivot points too tight 	<ul style="list-style-type: none"> • Replace valve • Lubricate/loosen pivot point
Only one unit will not hold position	<ul style="list-style-type: none"> • Oil leak between valve and cylinder • Faulty valve • Faulty lower poppet on lift valve 	<ul style="list-style-type: none"> • Repair leak or replace hose • Replace valve • Remove, clean, and replace
No units will hold position	<ul style="list-style-type: none"> • Problem is not hydraulic 	<ul style="list-style-type: none"> • Refer to the “Tasselrol” information elsewhere in this manual
Only one unit lowers slowly	<ul style="list-style-type: none"> • Faulty valve • Faulty lower poppet on lift valve 	<ul style="list-style-type: none"> • Replace valve • Remove, clean, replace
All units lower slowly	<ul style="list-style-type: none"> • Hydraulic oil not at operating temperature 	<ul style="list-style-type: none"> • Allow time for oil to warm up
In MANUAL mode, more than one unit lifts or lowers from one up/down switch	<ul style="list-style-type: none"> • Faulty valve 	<ul style="list-style-type: none"> • Replace valve
In AUTO mode, more than one unit raises from photo sensor	<ul style="list-style-type: none"> • Faulty valve 	<ul style="list-style-type: none"> • Replace valve
In AUTO mode, wrong unit raises from photo sensor	<ul style="list-style-type: none"> • Cylinder hoses are connected to the wrong cylinder • Electronic malfunction 	<ul style="list-style-type: none"> • Attach correct hoses to proper cylinder • Contact Hagie Customer Support for assistance
No units will lift	<ul style="list-style-type: none"> • Faulty Auto/Manual Switch • Blown Fuse • Faulty #1 valve, coil, or loose coil mounting nut • Loose wire connections • Faulty wire connections • Faulty main wire assembly 	<ul style="list-style-type: none"> • Replace switch • Find short in wire, repair, and replace fuse • Tighten or replace coil • Find loose connection, tighten • Replace or repair • Replace or repair

SECTION 10 –
MISCELLANEOUS



<p>Only one unit will not lift</p>	<ul style="list-style-type: none"> • In MANUAL mode, faulty Up/Down Switch • Light photo sensor assembly • Faulty valve, coil, or loose coil mounting nut • Loose wire connections • Lights of photo sensor not lined up with reflector • Faulty row wire assembly • Faulty sensor connector wire 	<ul style="list-style-type: none"> • Replace control box • Replace photo sensor • Tighten nut or replace coil • Find loose connections, tighten • Line up sensor with reflector • Replace or repair • Replace or repair
<p>No units will lower</p>	<ul style="list-style-type: none"> • Faulty Auto/Manual Switch • Blown fuse • In AUTO mode, LS valve assembly unplugged • Loose wire connections 	<ul style="list-style-type: none"> • Replace switch • Find short in wire, repair, and replace fuse • Plug in wire assembly • Find loose connection, tighten
<p>Only one unit will not lower</p>	<ul style="list-style-type: none"> • Faulty Up/Down Switch • Light photo sensor assembly • Faulty valve, coil, or loose coil mounting nut • Loose wire connections • Lights of photo sensor not lined up with reflector • Faulty row wire assembly • Faulty sensor connector wire assembly 	<ul style="list-style-type: none"> • Replace control box • Replace photo sensor • Tighten nut or replace coil • Find loose connections, tighten • Line up sensor with reflector • Replace or repair • Replace or repair
<p>No units will hold position</p>	<ul style="list-style-type: none"> • In AUTO mode, no crop moving under assemblies 	<ul style="list-style-type: none"> • Drive forward or select MANUAL mode
<p>In AUTO mode, wrong unit raises from sensor assembly</p>	<ul style="list-style-type: none"> • Row LS wire assembly plugged into wrong sensor connector 	<ul style="list-style-type: none"> • Plug correct wire assembly into proper row sensor connector assembly
<p>Entire electrical system is dead</p>	<ul style="list-style-type: none"> • Dead battery • Poor battery connection • Low charging rate • No charging rate • Battery Disconnect Switch is in the OFF position 	<ul style="list-style-type: none"> • Replace battery • Clean and tighten battery connections • Tighten alternator belt • Replace alternator • Turn Battery Disconnect Switch ON
<p>Light system does not function</p>	<ul style="list-style-type: none"> • Poor ground • Burned out bulb • Separation or short in wire • Blown fuse • Faulty switch • Ignition switch is OFF 	<ul style="list-style-type: none"> • Clean and tighten ground • Replace bulb • Check continuity and replace wire • Replace fuse • Replace switch • Turn ignition switch ON

Machine Valve Type

- **o** = Any machine with the original valve, Model Year 2007 or prior.
- **p** = 204/204SP machines with the new proportionate valve, Model Year 2008 and later.
- **c** = STS Combination Sprayer/Detasseler with the proportionate valve, Model Year 2007 or later.
- **x** = 204XP and DTS 8C (Combination Sprayer/Detasseler) with 12 valves, Model Year 2010.

Tasselrol/LS System

- Turn the ignition key to the ON position (do not start the engine).
- Turn the Tasselrol box to the ON position.
- Turn the Auto/Manual Switch to MANUAL.”
- Ensure there is nothing physically blocking any upper or lower sensor’s path to its reflector.

The display will show the status of the upper and lower photo sensor on each lift assembly. If the display shows a box (“□”) in all upper and lower areas, the unit is ready for operation. If the display shows a corn stalk (“☿”) in one or more areas, refer to the following information for troubleshooting.

The LEFT-CENTER sensors are used as examples.

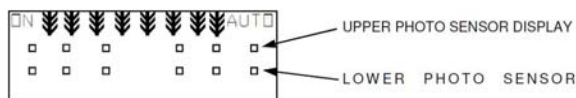

Tasselrol Display

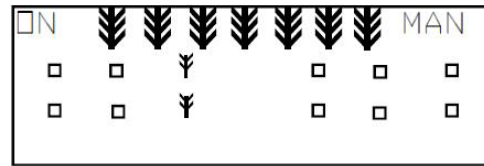

Manual Mode

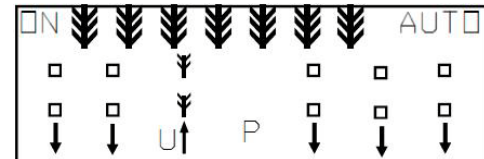

Auto Mode

Unit rises automatically

Photo Sensor Light Status	Possible Cause
Lights at both photo sensors	<ul style="list-style-type: none"> • Photo sensors not in line with reflector. Contact Hagie Customer Support for assistance.
No lights at either photo sensor	<ul style="list-style-type: none"> • Faulty connector cable (refer to your Parts Manual) • Faulty wire in connector cable (refer to your Parts Manual)

Tasseltrol Display

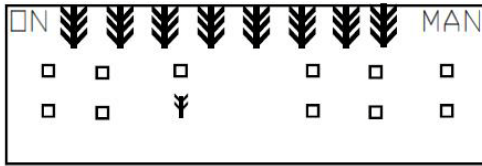

Manual Mode

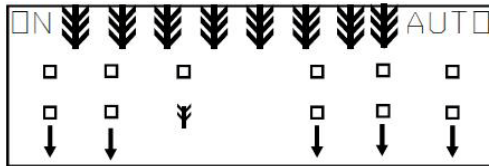

Auto Mode

Tasseltrol Display

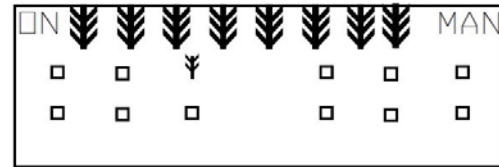

Manual Mode

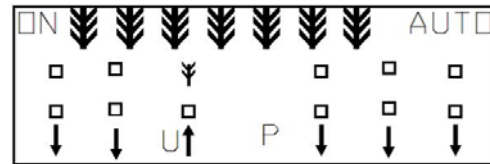

Auto Mode

Unit does NOT rise automatically

Photo Sensor Light Status	Possible Cause
Lights at lower photo sensor	<ul style="list-style-type: none"> Faulty wire in connector cable (refer to your Parts Manual) Photo sensor not in line with reflector. Contact Hagie Customer Support for assistance. Faulty wire in sensor assembly (refer to your Parts Manual)
No lights at lower photo sensor	<ul style="list-style-type: none"> Faulty wire in connector cable (refer to your Parts Manual)

Photo Sensor Light Status	Possible Cause
Lights at upper photo sensor	<ul style="list-style-type: none"> Faulty wire in sensor assembly (refer to your Parts Manual)
No lights at upper photo sensor	<ul style="list-style-type: none"> Faulty wire in connector cable (refer to your Parts Manual)



INDEX

2015 Product Warranty	1-17	Reversible Fan	5-5
4-2 Detasseler Combo Attachment - Adjustable	8-11	Rinse System	7-46
A Word From Hagie Manufacturing Company	1-1	Roll-Over Protection Structure (ROPS)	2-10
About This Manual	1-1	Rotating Beacons	2-7
Air Suspension Exhaust	10-26	Safety Decals	2-11
All-Wheel Steer (AWS)	4-16	Safety Messages Used In This Manual	1-2
Application	7-52	Safety Precautions	2-1
Batteries	6-1	Seat - Instructor	3-4
Battery Disconnect Switch	6-2	Seat - Operator (Deluxe)	3-1
Detasseling System - Operation	8-9	Seat - Operator (Premium)	3-2
Detasseling System Components	8-1	Seat Belt	2-6
Draining Your Solution Tank	7-45	Service - Bolt Torque	9-24
Droplet Monitoring System	7-38	Service - Engine Drive Belt	9-23
Emergency Exit	2-8	Service - Filters	9-9
Emergency Stop	2-7	Service - Fluids	9-1
Engine - Starting	4-1	Service - Lubrication	9-18
Engine Aftertreatment - Tier 4 Final	4-3	Service - Miscellaneous	9-27
Fence Row Applicator	7-40	Service - Toe-In	9-25
Filling Your Solution Tank	7-41	Service and Assistance	1-2
Fire Extinguisher	2-9	Service Intervals	9-32
First Aid Kit	2-9	Solution System - Operation	7-35
Foam Marker System	7-50	Solution System Components	7-28
Fuse and Relay Ratings	6-7	Specifications	1-6
Fuses and Relays	6-3	Spray Boom - Rear	7-26
Hand Wash System	10-26	Spray Boom Hose Clamp Installation	7-1
Hood Operation	10-28	Spray Booms - 120/132'	7-13
Hydraulic System Components	5-1	Spray Booms - 90/100'	7-3
Hydrostatic Drive	4-10	Storage	9-36
Identification	1-3	Tall Corn Package - Installation	10-29
Intended Use	2-1	Tasseltrol Flowchart	8-23
Ladder	5-8	Tasseltrol®/LS System 12™	8-13
Lifting Your Machine	10-5	Transporting	10-1
Machine Display	3-29	Tread Adjustment	5-6
Operator Presence Switch (OPS)	2-8	Troubleshooting	10-45
Operator's Station	3-5	Video Camera Input Connections	6-10
Quick-Tach System - Detasseler Combo	10-19		
Quick-Tach System - Spray Booms	10-7		
Reporting Accidents, Injuries, or Safety Concerns	1-2		

